

MMIC VCO w/ BUFFER AMPLIFIER, 2.6 - 2.8 GHz



Typical Applications

Low noise MMIC VCO w/Buffer Amplifier for:

- Wireless Infrastructure
- Industrial Controls
- Test Equipment
- Military

Features

- Pout: +5 dBm
- Phase Noise: -114 dBc/Hz @100 kHz
- No External Resonator Needed
- Single Supply: 3V @ 35mA
- 24 Lead 4x4mm QFN Package: 16 mm²

Functional Diagram

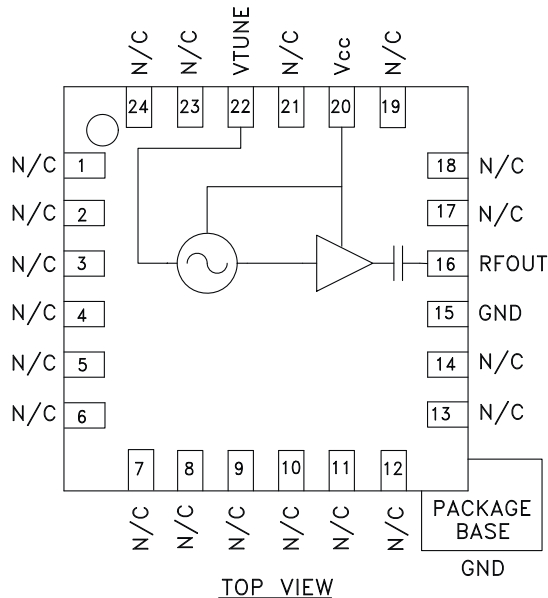

General Description

The HMC386LP4 & HMC386LP4E are GaAs InGaP Heterojunction Bipolar Transistor (HBT) MMIC VCOs with integrated resonators, negative resistance devices, varactor diodes, and buffer amplifiers. Covering 2.6 to 2.8 GHz, the VCO's phase noise performance is excellent over temperature, shock, vibration and process due to the oscillator's monolithic structure. Power output is 5 dBm typical from a single supply of 3V @ 35mA. The voltage controlled oscillator is packaged in a low cost leadless QFN 4x4 mm surface mount package.

Electrical Specifications, $T_A = +25\text{ }^\circ\text{C}$, $V_{CC} = +3\text{V}$

Parameter	Min.	Typ.	Max.	Units
Frequency Range	2.6 - 2.8			GHz
Power Output	2	5		dBm
SSB Phase Noise @ 100 kHz Offset, $V_{tune} = +5\text{V}$ @ RF Output		-114		dBc/Hz
Tune Voltage (V_{tune})	0		10	V
Supply Current (I_{cc}) ($V_{CC} = +3\text{V}$)		35		mA
Tune Port Leakage Current			10	μA
Output Return Loss		9		dB
Harmonics				
2nd		-5		dBc
3rd		-15		dBc
Pulling (into a 2.0:1 VSWR)		3		MHz pp
Pushing @ $V_{tune} = +5\text{V}$		2		MHz/V
Frequency Drift Rate		0.3		MHz/ $^\circ\text{C}$

Information furnished by Analog Devices is believed to be accurate and reliable. However, no responsibility is assumed by Analog Devices for its use, nor for any infringements of patents or other rights of third parties that may result from its use. Specifications subject to change without notice. No license is granted by implication or otherwise under any patent or patent rights of Analog Devices. Trademarks and registered trademarks are the property of their respective owners.

For price, delivery, and to place orders: Analog Devices, Inc., One Technology Way, P.O. Box 9106, Norwood, MA 02062-9106
Phone: 781-329-4700 • Order online at www.analog.com
Application Support: Phone: 1-800-ANALOG-D

HMC386* PRODUCT PAGE QUICK LINKS

Last Content Update: 02/23/2017

COMPARABLE PARTS

View a parametric search of comparable parts.

EVALUATION KITS

- HMC386LP4 Evaluation Board

DOCUMENTATION

Application Notes

- Determining the FM Bandwidth of a Wideband Varactor Tuned VCO

Data Sheet

- HMC386 Data Sheet

REFERENCE MATERIALS

Quality Documentation

- Package/Assembly Qualification Test Report: LP4, LP4B, LP4C, LP4K (QTR: 2013-00487 REV: 04)
- Package/Assembly Qualification Test Report: Plastic Encapsulated QFN (QTR: 05006 REV: 02)
- Semiconductor Qualification Test Report: GaAs HBT-A (QTR: 2013-00228)

DESIGN RESOURCES

- HMC386 Material Declaration
- PCN-PDN Information
- Quality And Reliability
- Symbols and Footprints

DISCUSSIONS

View all HMC386 EngineerZone Discussions.

SAMPLE AND BUY

Visit the product page to see pricing options.

TECHNICAL SUPPORT

Submit a technical question or find your regional support number.

DOCUMENT FEEDBACK

Submit feedback for this data sheet.



MMIC VCO w/ BUFFER AMPLIFIER, 2.6 - 2.8 GHz

Frequency vs. Tuning Voltage, T = 25°C

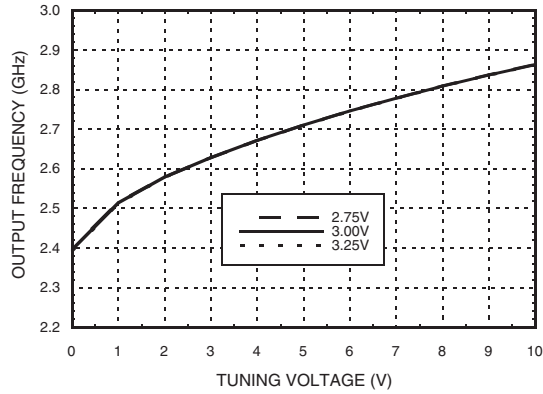

Frequency vs. Tuning Voltage, Vcc = +3V

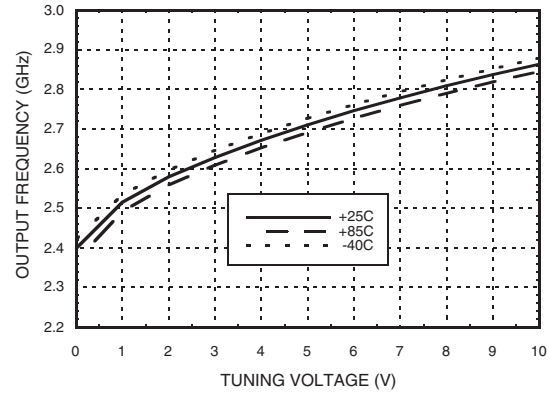

Sensitivity vs. Tuning Voltage, Vcc = +3V

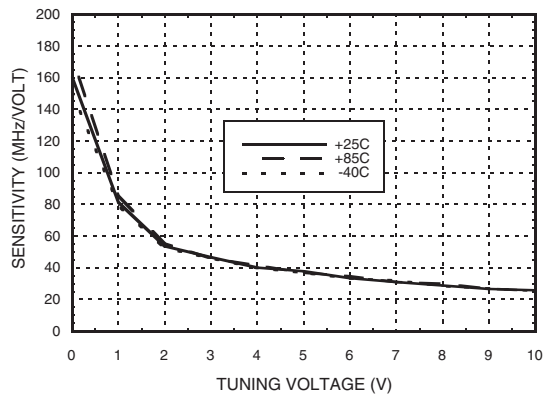

Output Power vs. Tuning Voltage, Vcc = +3V

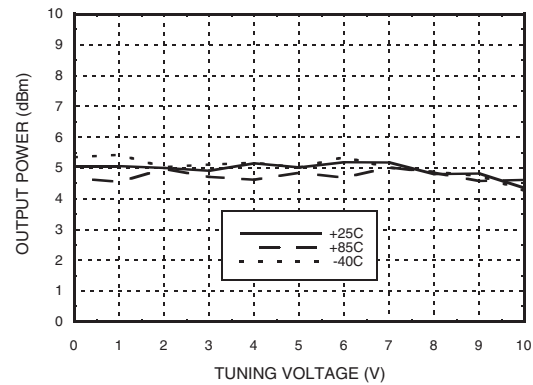

Phase Noise vs. Tuning Voltage

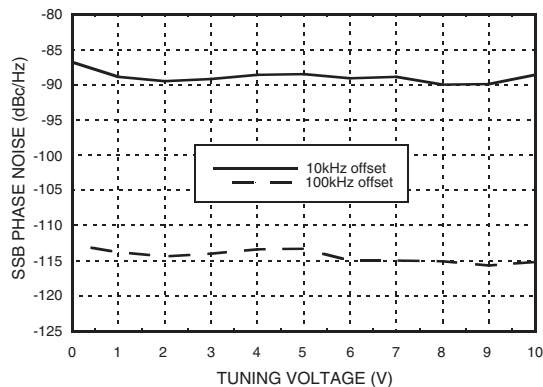

Typical SSB Phase Noise @ Vtune= +5V

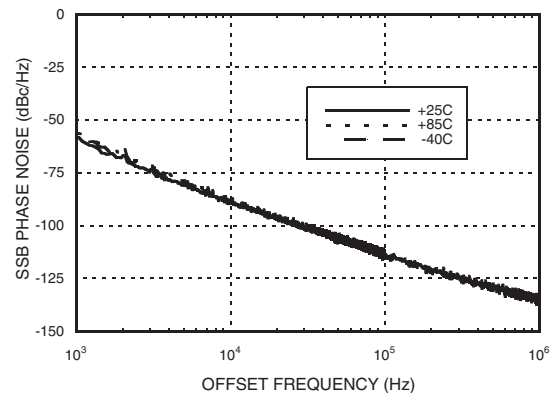



MMIC VCO w/ BUFFER AMPLIFIER, 2.6 - 2.8 GHz

Absolute Maximum Ratings

Vcc	+3.5V
Vtune	0 to +11V
Channel Temperature	135 °C
Thermal Resistance (R _{TH}) (junction to package base)	138 °C/W
Storage Temperature	-65 to +150 °C
Operating Temperature	-40 to +85 °C

Typical Supply Current vs. Vcc

Vcc (V)	Icc (mA)
2.75	30
3.0	35
3.25	40

Note: VCO will operate over full voltage range shown above.



**ELECTROSTATIC SENSITIVE DEVICE
OBSERVE HANDLING PRECAUTIONS**

Outline Drawing

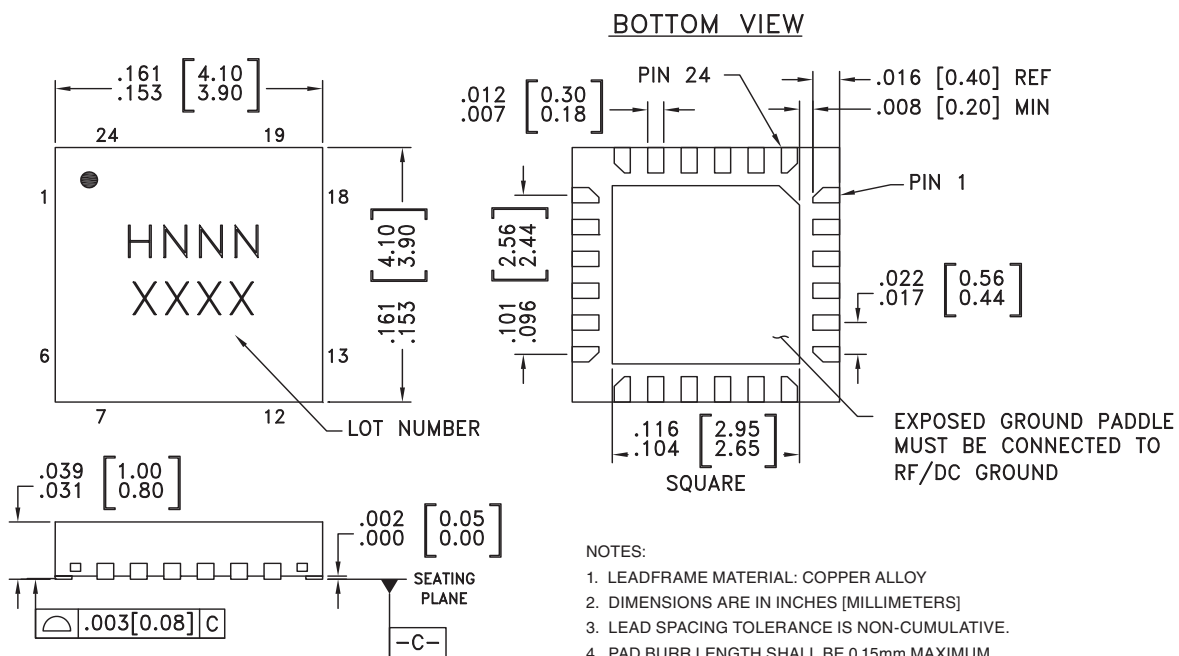

Package Information

Part Number	Package Body Material	Lead Finish	MSL Rating	Package Marking ^[3]
HMC386LP4	Low Stress Injection Molding Plastic	Sn/Pb Solder	MSL1 ^[1]	H386 XXXX
HMC386LP4E	RoHS-compliant Low Stress Injection Molding Plastic	100% matte Sn	MSL1 ^[2]	H386 XXXX

[1] Max peak reflow temperature of 235 °C

[2] Max peak reflow temperature of 260 °C

[3] 4-Digit lot number XXXX



**MMIC VCO w/ BUFFER
AMPLIFIER, 2.6 - 2.8 GHz**

Pin Descriptions

Pin Number	Function	Description	Interface Schematic
1- 14, 17 - 19, 21, 23, 24	N/C	The pins are not connected internally; however, all data shown herein was measured with these pins connected to RF/DC ground externally.	
15	GND	This pin must be connected to RF & DC ground. Package bottom has an exposed metal paddle that must be RF & DC grounded.	
16	RFOUT	RF output (AC coupled)	
20	Vcc	Supply Voltage Vcc= 3V	
22	VTUNE	Control Voltage Input. Modulation port bandwidth dependent on drive source impedance.	

Evaluation PCB

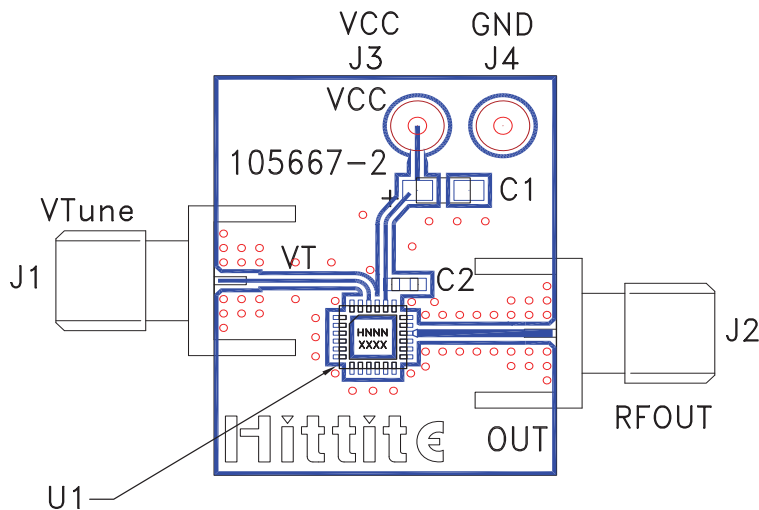

List of Materials for Evaluation PCB 105706 [1]

Item	Description
J1 - J2	PCB Mount SMA RF Connector
J3 - J4	DC Pin
C1	4.7 μF Tantalum Capacitor
C2	10,000 pF Capacitor, 0603 Pkg.
U1	HMC386LP4 / HMC386LP4E VCO
PCB [2]	105667 Eval Board

[1] Reference this number when ordering complete evaluation PCB

[2] Circuit Board Material: Rogers 4350 or Arlon 25FR

The circuit board used in the application should use RF circuit design techniques. Signal lines should have 50 Ohm impedance while the package ground leads and exposed paddle should be connected directly to the ground plane similar to that shown. A sufficient number of via holes should be used to connect the top and bottom ground planes. The evaluation circuit board shown is available from Hittite upon request.

Information furnished by Analog Devices is believed to be accurate and reliable. However, no responsibility is assumed by Analog Devices for its use, nor for any infringements of patents or other rights of third parties that may result from its use. Specifications subject to change without notice. No license is granted by implication or otherwise under any patent or patent rights of Analog Devices. Trademarks and registered trademarks are the property of their respective owners.

For price, delivery, and to place orders: Analog Devices, Inc., One Technology Way, P.O. Box 9106, Norwood, MA 02062-9106 Phone: 781-329-4700 • Order online at www.analog.com Application Support: Phone: 1-800-ANALOG-D