

| | |
|--|------------------|
| For board-to-micro coaxial wire | CS Series |
| Micro coaxial connectors (Space saving) | |

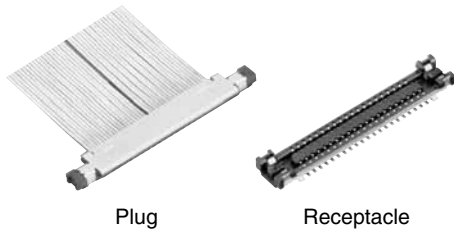

RoHS compliant

FEATURES

1. Cable pitch of 0.25 mm helps reduce overall board space. (Vertical mating type: 1.27 mm mated height and 2.81 mm wide)

The two-row mating structure ensures insertion reliability. The center island is resistant to problems related to plug/receptacle mating.

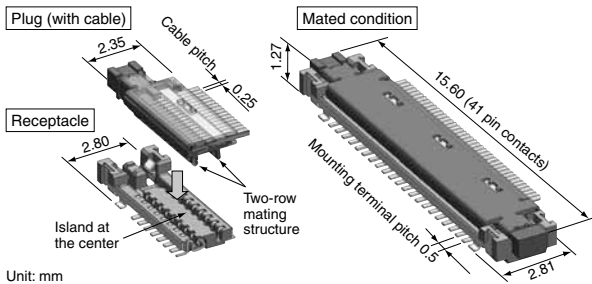

2. "TOUGH CONTACT" with strong resistance to various environments provides high contact reliability and facilitates connection work with tactile feedback.

Ni barrier construction
(Against solder rise!)

Bellows contact construction
(Against dropping!)

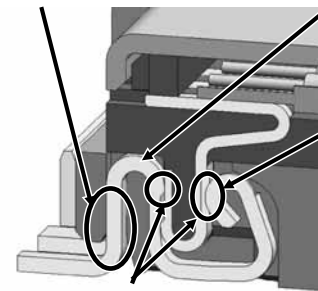

Porosity treatment
(Against corrosive gases!)

V notch and Double contact constructions
(Against foreign particles and flux!)

3. Compatible wires: Coaxial AWG #44 to #46 (outer diameter: 0.25 mm or less), AWG #38 (outer diameter: 0.32 mm or less, the #38-compatible plug only)

APPLICATIONS

Tablets, laptops, mobile phones, digital still cameras and digital video cameras.

ORDERING INFORMATION

AXC **1** **S**

- 5: Receptacle
- 6: Plug
- 8: Plug attachment (Cover shell)
- Mated type
- 1: Vertical
- S: Slim type
- No. of pins (2-digits)
- Receptacle <Terminal pitch>
- 5: 0.5 mm
- Plug <Cable pitch>
- 7: 0.25 mm
- Function (Plug/Receptacle)
- 0: Signal wire only
- 4: #38 wire for power supply (Two both ends × 2 wires)
- [Plug attachment only]
- 1: Plug cover shell
- [Plug attachment only]
- 0: Signal wire only
- 4: #38 wire for power supply (Two both ends × 2 wires)

PRODUCT TYPES**1. Receptacle**

| Mated height | Number of pins | Part number | Packing | |
|--------------|----------------|-------------------------|-----------------------|--------------|
| | | Receptacle (Board side) | Inner carton (1-reel) | Outer carton |
| 1.27mm | 21 | AXC51S2150 | 5,000 pcs. | 10,000 pcs. |
| | 41 | AXC51S4150 | | |
| | 51 | AXC51S5150 | | |

2. Plug (unit)

| Mated height | Number of pins | #38-compatible | Part number | Packing | |
|--------------|----------------|--------------------------------|-------------------|-----------------------|--------------|
| | | | Plug (Cable side) | Inner carton (1-reel) | Outer carton |
| 1.27mm | 21 | Available (Each two both ends) | AXC61S2174 | 5,000 pcs. | 10,000 pcs. |
| | 41 | Available (Each two both ends) | AXC61S4174 | | |
| | 51 | Not available | AXC61S5170 | | |

3. Plug cover shell

| Mated height | Number of pins | #38-compatible | Part number | Packing | |
|--------------|----------------|----------------|------------------------------|-----------------------|--------------|
| | | | Plug cover shell (Plug side) | Inner carton (1-reel) | Outer carton |
| 1.27mm | 21 | Available | AXC81S21714 | 5,000 pcs. | 10,000 pcs. |
| | 41 | Available | AXC81S41714 | | |
| | | Not available | AXC81S41710 | | |
| | 51 | Not available | AXC81S51710 | | |

Notes: 1. Order unit:

For volume production: 1-inner carton (1-reel) units

Samples for mounting check: 50-connector units. Please contact our sales office.

2. Please contact us for connectors having a number of pins other than those listed above.

SPECIFICATIONS

1. Characteristics

| Item | | Specifications | Conditions | | | | | | | | | | | | | | | | | | |
|---|--|---|---|-------|------------------|----------------|---|---------------------------------|----|---|---|--------|---|--------------------------------|----|---|---|--------|--|---------------------------------|--|
| Electrical characteristics (Connector unit) | Rated current | 0.25A/terminal (Max. 4A at total pin contacts) | Maximum current that 1 pin contact can conduct. (connector characteristic except cable) | | | | | | | | | | | | | | | | | | |
| | Rated voltage | 50V AC/DC | | | | | | | | | | | | | | | | | | | |
| | Insulation resistance | Min. 1.000MΩ (initial) | Using 250 V DC megger (applied for 1 minute) | | | | | | | | | | | | | | | | | | |
| | Breakdown voltage | 90V AC for 1 minute | Rated voltage is applied for one minute and check for short circuit or damage with a detection current of 1mA. | | | | | | | | | | | | | | | | | | |
| | Contact resistance | Signal: Max. 70mΩ (initial) Ground: Max. 40mΩ (initial) | Based on method of JIS C 5402 | | | | | | | | | | | | | | | | | | |
| Applicable electrical wire | | AWG #44, 46 (Outside diameter: 0.25mm or less) AWG #38 (Outside diameter: 0.32mm or less) | #38-compatible plug only | | | | | | | | | | | | | | | | | | |
| Mechanical characteristics | Composite insertion force | Max. 1.2 × No. of pins + 2.4N (initial) | | | | | | | | | | | | | | | | | | | |
| | Composite removal force | Min. 0.165 × No. of pins + 0.33N | | | | | | | | | | | | | | | | | | | |
| | Holding force for terminal (Receptacle) | Contact: Min. 0.20N/terminal Shell: Min. 0.20N/point | Measured the maximum load applied until the press-fit terminals were removed in the axial direction. | | | | | | | | | | | | | | | | | | |
| | Wire tensile strength | Min. 2.5N (Min. 21 pins) Min. 5N (Min. 41 pins) | When all wires bundled together are pulled, the mated joint must not break. Pulling direction: Wire leading direction | | | | | | | | | | | | | | | | | | |
| Environmental characteristics | Ambient temperature | -55°C to +85°C | No freezing at low temperatures. No dew condensation. | | | | | | | | | | | | | | | | | | |
| | Storage environment | -55°C to +85°C (Product unit) -40°C to +50°C (Packing style) | No freezing at low temperatures. No dew condensation. | | | | | | | | | | | | | | | | | | |
| | Thermal shock resistance (Receptacle and plug mated) | 5 cycles, insulation resistance min. 100MΩ, increment of contact resistance max. 40mΩ | Conformed to MIL-STD-202F, method 107G <table border="1"> <thead> <tr> <th>Order</th> <th>Temperature (°C)</th> <th>Time (minutes)</th> </tr> </thead> <tbody> <tr> <td>1</td> <td>-55⁰/₃</td> <td>30</td> </tr> <tr> <td>2</td> <td>∅</td> <td>Max. 5</td> </tr> <tr> <td>3</td> <td>85⁰/₃</td> <td>30</td> </tr> <tr> <td>4</td> <td>∅</td> <td>Max. 5</td> </tr> <tr> <td></td> <td>-55⁰/₃</td> <td></td> </tr> </tbody> </table> | Order | Temperature (°C) | Time (minutes) | 1 | -55 ⁰ / ₃ | 30 | 2 | ∅ | Max. 5 | 3 | 85 ⁰ / ₃ | 30 | 4 | ∅ | Max. 5 | | -55 ⁰ / ₃ | |
| | Order | Temperature (°C) | Time (minutes) | | | | | | | | | | | | | | | | | | |
| | 1 | -55 ⁰ / ₃ | 30 | | | | | | | | | | | | | | | | | | |
| | 2 | ∅ | Max. 5 | | | | | | | | | | | | | | | | | | |
| | 3 | 85 ⁰ / ₃ | 30 | | | | | | | | | | | | | | | | | | |
| 4 | ∅ | Max. 5 | | | | | | | | | | | | | | | | | | | |
| | -55 ⁰ / ₃ | | | | | | | | | | | | | | | | | | | | |
| Humidity resistance (Receptacle and plug mated) | 120 hours, insulation resistance min. 100MΩ, increment of contact resistance max. 40mΩ | MIL-STD-1344A, METHOD 1002 Bath temperature 40±2°C, humidity 90 to 95% R.H. | | | | | | | | | | | | | | | | | | | |
| Saltwater spray resistance (Receptacle and plug mated) | 24 hours, insulation resistance min. 100MΩ, increment of contact resistance max. 40mΩ | MIL-STD-1344A, METHOD 1001 Bath temperature 35±2°C, saltwater concentration 5±1% | | | | | | | | | | | | | | | | | | | |
| H ₂ S resistance (Receptacle and plug mated) | 48 hours, increment of contact resistance max. 40mΩ | JEIDA-38-1984 Bath temperature 40±2°C, gas concentration 3±1 ppm, humidity 75 to 80% R.H. | | | | | | | | | | | | | | | | | | | |
| Insertion and removal life | | Mechanical life: 30 times, increment of contact resistance max. 40mΩ Min. 0.165 composite removal force × No. of pins + 0.33N | Repeated insertion and removal speed of max. 200 times/hours | | | | | | | | | | | | | | | | | | |
| Resistance to soldering heat | Receptacle | Initial electrical and mechanical characteristics must be maintained. | Reflow soldering: Max. peak temperature of 260°C, 2 cycles (PC board surface temperature of near connector terminals) Soldering iron: 350°C within 3s, 300°C within 5s | | | | | | | | | | | | | | | | | | |
| | Plug | Initial electrical and mechanical characteristics must be maintained. | Connecting wires portion pulse heat: Max. peak temperature of 300°C, 3s (Don't touch the heater head to molded portion) Plug cover shell soldering portion: Soldering iron: 350°C within 3s, 300°C within 5s | | | | | | | | | | | | | | | | | | |

2. Material and surface treatment

1. Receptacle

| Part name | Material | Color | Surface treatment |
|----------------|----------------------|-------|---|
| Molded portion | LCP resin (UL 94V-0) | Black | — |
| Contact | Copper alloy | — | Contact portion: Ni plating on base, Au plating on surface (Min. 0.1μm) Soldering portion: Ni plating on base, Au plating on surface (Except for front edge of terminal) |
| Shell | Copper alloy | — | Contact portion: Ni plating on base, Au plating on surface Soldering portion: Ni plating on base, Au plating on surface (Except for front edge of terminal) |

2. Plug

| Part name | Material | Color | Surface treatment |
|----------------|----------------------|-------|--|
| Molded portion | LCP resin (UL 94V-0) | Black | — |
| Post | Copper alloy | — | Contact portion: Ni plating on base, Au plating on surface (Min. 0.1μm) Soldering wire portion: Ni plating on base, Au plating on surface |
| Insert shell | Copper alloy | — | Ni plating |

3. Plug cover shell

| Part name | Material | Color | Surface treatment |
|-----------|--------------|-------|---|
| Shell | Copper alloy | — | Ni plating on base, Au plating on surface |

DIMENSIONS (Unit: mm)

• Receptacle

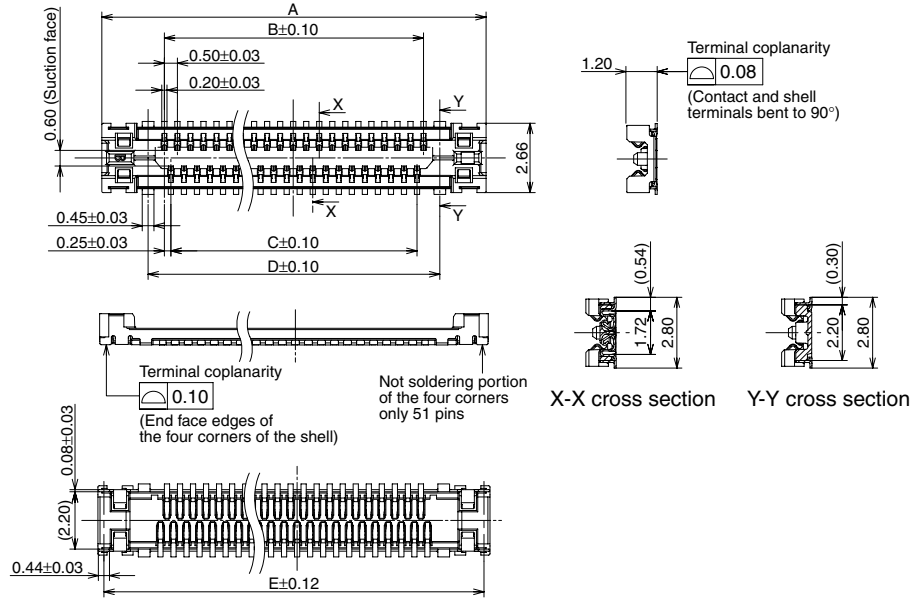

Dimension table (mm)

| Number of pins/ dimension | A | B | C | D | E |
|------------------------------|-------|-------|-------|-------|-------|
| 21 | 9.80 | 5.00 | 4.50 | 6.25 | 9.34 |
| 41 | 14.80 | 10.00 | 9.50 | 11.25 | 14.34 |
| 51 | 17.30 | 12.50 | 12.00 | 13.75 | 16.84 |

General tolerance: ±0.2

• Plug (unit) 21, 41 pin contacts

AXC61S2174
AXC61S4174

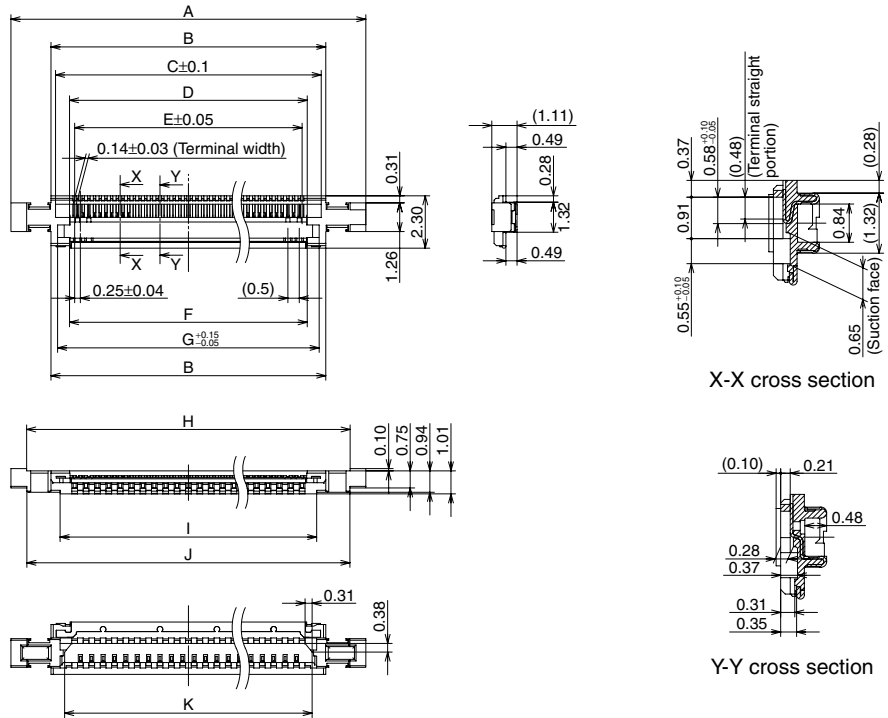
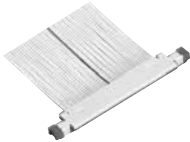

Dimension table (mm)

| Number of pins/ dimension | A | B | C | D | E | F | G | H | I | J | K |
|------------------------------|-------|-------|-------|-------|-------|-------|-------|-------|-------|-------|-------|
| 21 | 10.60 | 7.08 | 6.68 | 5.45 | 5.00 | 5.45 | 6.50 | 9.22 | 6.28 | 9.20 | 5.88 |
| 41 | 15.60 | 12.08 | 11.68 | 10.45 | 10.00 | 10.45 | 11.50 | 14.22 | 11.28 | 14.20 | 10.88 |

General tolerance: ±0.2

• **Plug (assembled condition) 21, 41 pin contacts (#38 wire for power supply)**

Regarding cable pattern, please refer to "Notes".

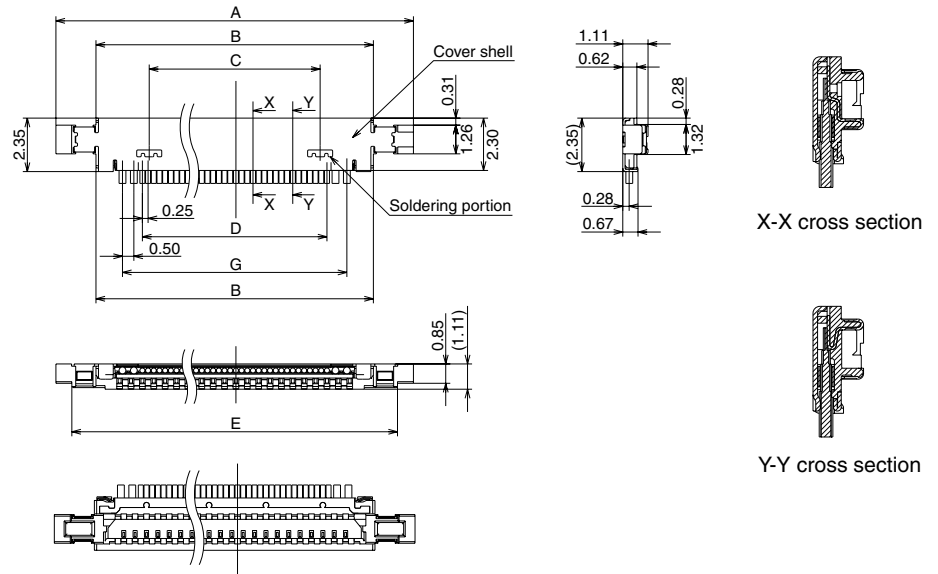

Dimension table (mm)

| Number of pins/ dimension | A | B | C | D | E | F | G |
|------------------------------|-------|-------|------|------|-------|-------|------|
| 21 | 10.60 | 7.08 | 2.40 | 3.00 | 9.20 | 6.00 | 4.75 |
| 41 | 15.60 | 12.08 | 7.40 | 8.00 | 14.20 | 11.00 | 9.75 |

General tolerance: ± 0.2

• **Plug cover shell 21, 41 pin contacts**

AXC81S21714

AXC81S41714

Dimension table (mm)

| Number of pins/ dimension | A | B | C |
|------------------------------|-------|-------|------|
| 21 | 9.00 | 6.86 | 2.40 |
| 41 | 14.00 | 11.86 | 7.40 |

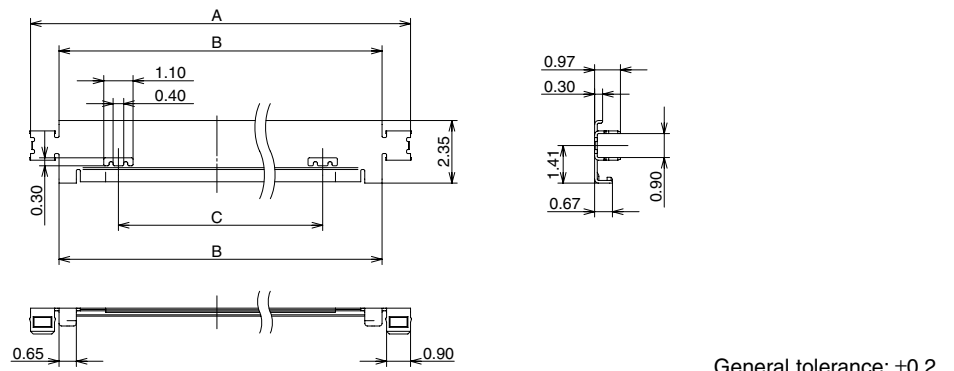

General tolerance: ± 0.2

• **Plug (unit) 51 pin contacts**
AXC61S5170

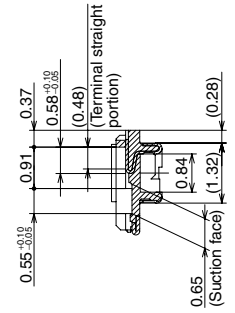
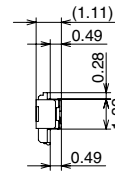
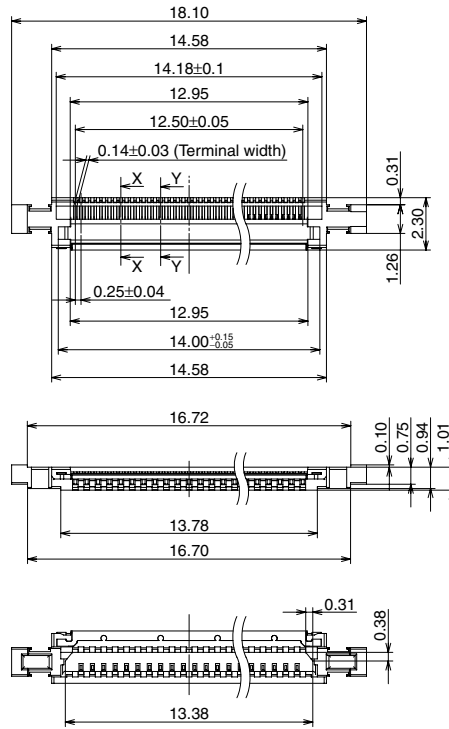

X-X cross section

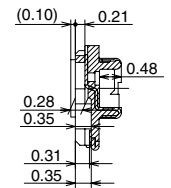

Y-Y cross section

General tolerance: ±0.2

• **Plug (assembled condition)**
41 pin contacts
51 pin contacts (signal wire only)
Regarding cable pattern, please refer to "Notes".

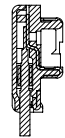
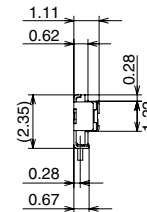
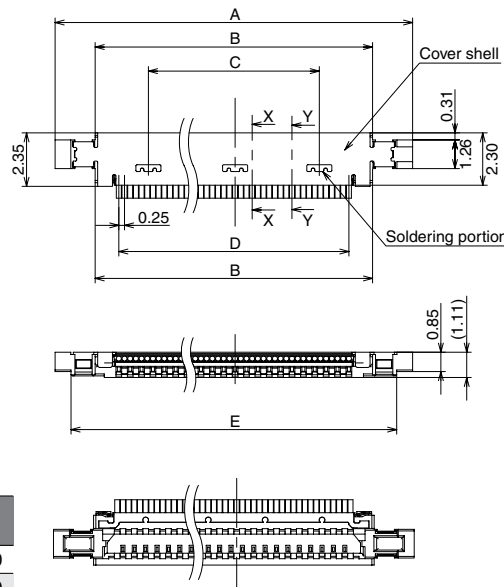

X-X cross section

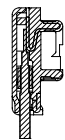

Y-Y cross section

General tolerance: ±0.2

Dimension table (mm)

| Number of pins/ dimension | A | B | C | D | E |
|------------------------------|-------|-------|------|-------|-------|
| 41 | 15.60 | 12.08 | 7.40 | 10.00 | 14.20 |
| 51 | 18.10 | 14.58 | 9.90 | 12.50 | 16.70 |

• **Plug cover shell 41 pin contacts/51 pin contacts**
AXC81S41710
AXC81S51710

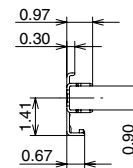
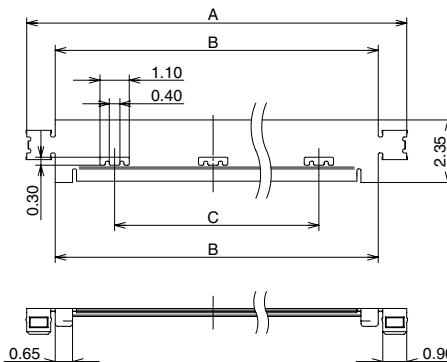

Dimension table (mm)

| Number of pins/ dimension | A | B | C |
|------------------------------|-------|-------|------|
| 41 | 14.00 | 11.86 | 7.40 |
| 51 | 16.50 | 14.36 | 9.90 |

General tolerance: ±0.2

• Receptacle and Plug are mated

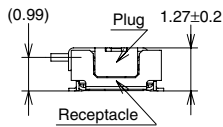

EMBOSSED TAPE DIMENSIONS (Unit: mm)

• Tape dimensions

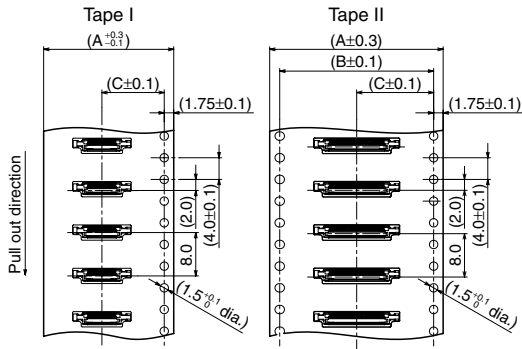

• Plastic reel dimensions (Conforming to EIAJ ET-7200B)

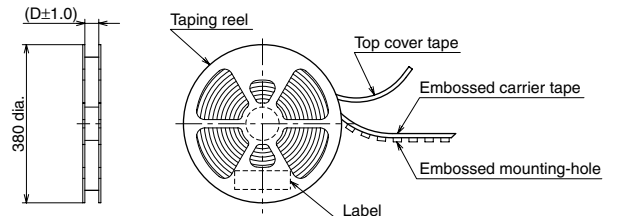

• Dimension table (Unit: mm)

| Type | Number of pins | | Type of taping | A | B | C | D |
|--------------------------------|----------------|--------|----------------|------|------|------|------|
| | Receptacle | Plug | | | | | |
| Common for receptacle and plug | 21, 41, 51 | 21 | Tape I | 24.0 | — | 11.5 | 25.4 |
| | — | 41, 51 | Tape II | 32.0 | 28.4 | 14.2 | 33.4 |

• Metal hoop reel dimensions (Plug cover shell)

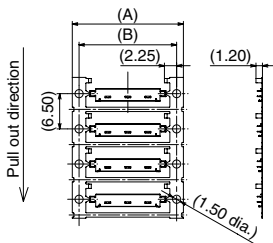

• Plastic reel dimensions (Conforming to EIAJ ET-7200B)

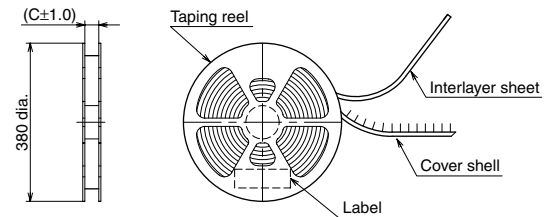

Dimension table (mm)

| Number of pins/ dimension | A | B | C |
|------------------------------|------|------|------|
| 21 | 15.5 | 13.0 | 17.4 |
| 41 | 20.5 | 18.0 | 25.4 |
| 51 | 23.0 | 20.5 | 25.4 |

• Connector orientation with respect to direction of progress of embossed tape

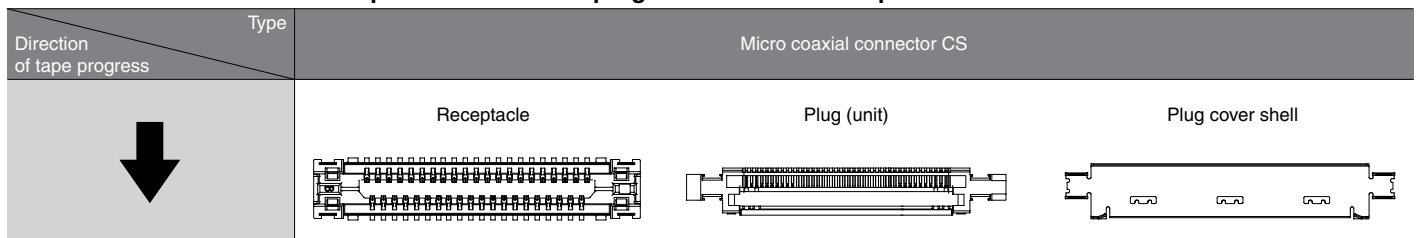

Please refer to the latest product specifications when designing your product.

Notes on Using Micro Coaxial Connectors

NOTES (Unit: mm)

■ Safety precautions

Observe the following safety precautions to prevent accidents and injuries.

1) The use of the connector outside of the specified rated current and breakdown voltage ranges may cause abnormal heating, smoke, and fire.

Never use the connector beyond the specified ranges of the product.

2) In order to avoid accidents, make sure you have thoroughly reviewed the specifications before use. Consult us if you plan to use the product in a way not covered by the specifications.

3) We are consistently striving to improve quality and reliability. However, the fact remains that electrical components and devices generally fail at a given statistical probability. Furthermore, their durability varies depending on where and how they are used. Please be sure to verify electrical components and devices under actual conditions before use. Continuously using them in a state of degraded performance may cause deterioration in insulation performance, thus resulting in abnormal heat generation, smoke generation, or fire. To avoid that, we ask you to implement safe designs that include redundancy, fire prevention, and malfunction prevention. Also, please conduct periodic maintenance so that no accidents resulting in injury or death, fire, or harm to society will be caused as a result of product failure or service life.

■ About plug

The plug of this product is wired by soldering the 0.25 mm pitch (CS)/0.4 mm pitch (CF) cable.

If you will be harnessing, carry it out based on the separately attached "Plug Assembly Procedures". Make sure to get familiar with and observe all the precautions in the procedures.

Note: If you would like "Plug Assembly Procedures", please inquire at one of our sales offices.

• Caution regarding harness handling procedures.

To prevent the cable from being severed and to prevent damage to the product, please handle carefully making sure not to apply undue stress to the base of the cable after connecting it and after mating the connector.

• Caution regarding harness design

To prevent the cable from being severed and to prevent damage to the product, please place and secure the cable in a way that prevents the base of the cable from becoming stressed.

■ About receptacle

• PC board design

Design the recommended foot pattern in order to secure the mechanical strength in the soldered areas of the terminal.

• About (CF)

Use all the soldering terminals as GND for connecting GND stably.

• Connector mounting

When mounting, if there is too much suction nozzle pressure, the molded and metal parts might deform and break.

Please check beforehand.

• Soldering

1) Manual soldering.

• Since this connector is the low profile type the amount of solder supplied should be closely monitored.

Too much solder during manual soldering may cause solder creeping near the contacting part or a short circuit with the shell (GND).

• Make sure that the soldering iron tip is heated within the temperature and time limits indicated in the specifications.

• Flux from the solder wire may adhere to the contact surfaces during soldering operations. After soldering, carefully check the contact surfaces and clean off any flux before use.

• Be aware that a load applied to the connector terminals while soldering may displace the contact.

• Thoroughly clean the iron tip.

CS series

• Receptacle

Recommended PC board pattern (mounting pad layout)
(Top view)

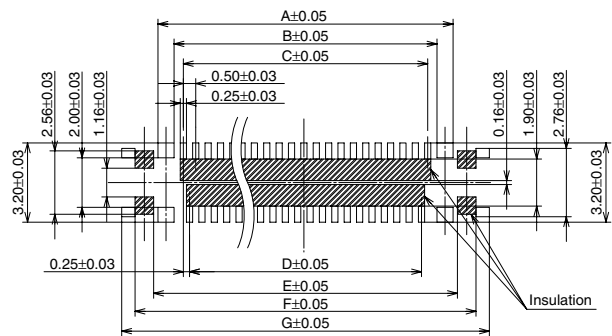

Recommended window size of metal mask

Metal mask thickness: When 120μm

(Signal terminal portion opening area ratio: 60%)

(GND terminal portion opening area ratio: 70%)

(Shell edge terminal portion at four corners opening area ratio: 60%)

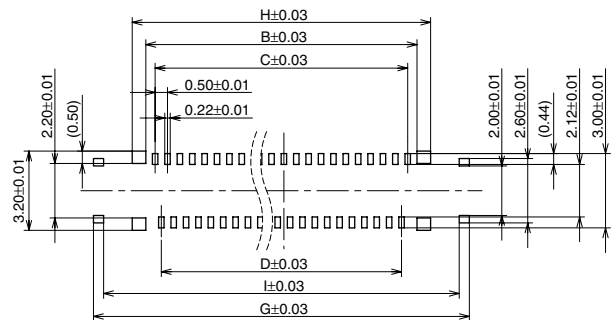

Dimension table (mm)

| Number of pins/ dimension | A | B | C | D | E | F | G | H | I |
|------------------------------|-------|-------|-------|-------|-------|-------|-------|-------|-------|
| 21 | 7.05 | 5.75 | 5.00 | 4.50 | 7.40 | 8.90 | 9.98 | 6.85 | 9.16 |
| 41 | 12.05 | 10.75 | 10.00 | 9.50 | 12.40 | 13.90 | 14.98 | 11.85 | 14.16 |
| 51 | 14.55 | 13.25 | 12.50 | 12.00 | 14.90 | 16.40 | 17.48 | 14.35 | 16.66 |

• Plug

21, 41 pin contacts (#38 wire for power supply)
Recommended cable pattern

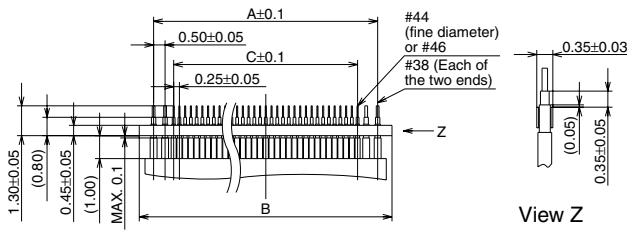

Dimension table (mm)

| Number of pins/dimension | A | B | C |
|--------------------------|------|-------|------|
| 21 | 4.75 | 6.00 | 3.00 |
| 41 | 9.75 | 11.00 | 8.00 |

41 pin contacts/51 pin contacts (signal wire only)
Recommended cable pattern

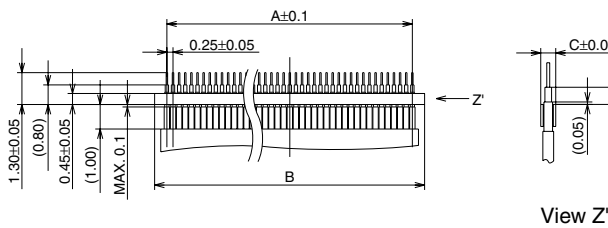

Dimension table (mm)

| Number of pins/dimension | A | B | C |
|--------------------------|-------|-------|------|
| 41 | 10.00 | 11.00 | 0.34 |
| 51 | 12.50 | 13.50 | 0.31 |

CF series

• Receptacle

Recommended PC board pattern (mounting pad layout)

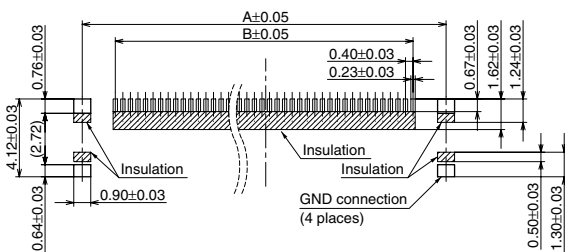

Recommended window size of metal mask

Metal mask thickness: When 120µm
(Signal terminal portion opening area ratio: 70%)
(GND terminal portion opening area ratio: 80%)

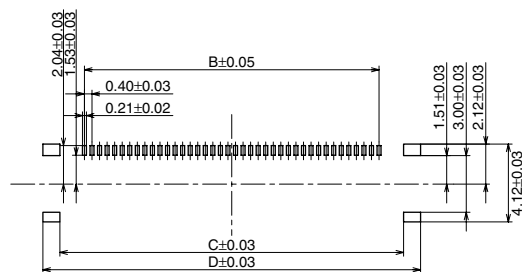

Dimension table (mm)

| Number of pins/dimension | A | B | C | D |
|--------------------------|-------|-------|-------|-------|
| 40 | 19.10 | 15.60 | 18.20 | 20.00 |

• Plug

Recommended cable pattern

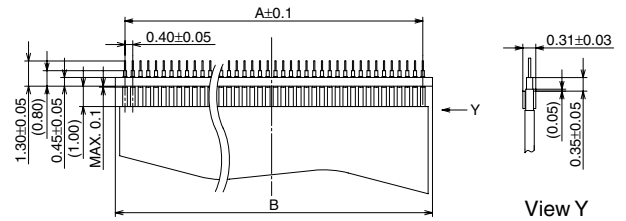

Dimension table (mm)

| Number of pins/dimension | A | B |
|--------------------------|-------|-------|
| 40 | 15.60 | 16.60 |

2) Reflow soldering

- Screen-printing is recommended for printing paste solder.
- To determine the relationship between the screen opening area and the PC board foot pattern area, refer to the diagrams in the recommended patterns for PC boards and metal masks. Make sure to use the terminal tip as a reference position when setting.
- Too much solder may cause solder creeping near the contacting part or a short circuit with the shell (GND).

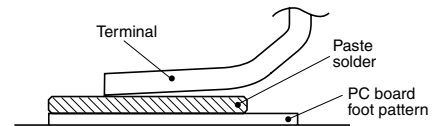

- Consult us when using a screen-printing thickness other than that recommended.
- Depending on the size of the connector being used, self alignment may not be possible. Accordingly, carefully position the terminal with the PC board pattern.
- The recommended reflow temperature profile is given in the figure below

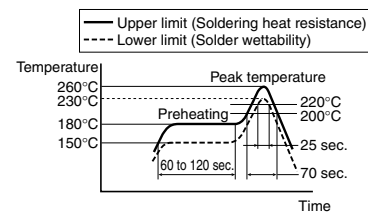

- The temperature is measured on the surface of the PC board near the connector terminal.
 - Certain solder and flux types may cause serious solder creeping. Solder and flux characteristics should be taken into consideration when setting the reflow soldering conditions.
 - Do not apply adhesive to secure the connector, because it can affect the spring action of the contact.
 - When coating the PC board after soldering the connector to prevent the deterioration of insulation, perform the coating in such a way so that the coating does not get on the connector.
- ### 3) Reworking on a soldered portion
- Finish reworking in one operation.
 - For reworking of the solder bridge, use a soldering iron with a flat tip. Do not add flux, otherwise, the flux may creep to the contact parts.
 - Use a soldering iron whose tip temperature is within the temperature range specified in the specifications.

Notes on Using Micro Coaxial Connectors

4) Others

- Do not drop or handle the connector carelessly. Otherwise, the terminals may become deformed due to excessive force or applied solderability may degrade.
- When cutting or bending the PC board after mounting the connector, be careful that the soldered sections are subjected to excessive forces.

■ Insertion / Removal and mating retention of connectors

- Do not insert or remove the connector when it is not soldered. Also, forcibly applied external pressure on the terminals can weaken the adherence of the terminals to the molded part or cause the terminals to lose their evenness.
- Excessive prying-force applied to one end may cause product breakage and separation of the solder joints at the terminal. Excessive force applied for insertion in a pivot action as shown may also cause product breakage. Always align the connector with the mating part and slide it in parallel.

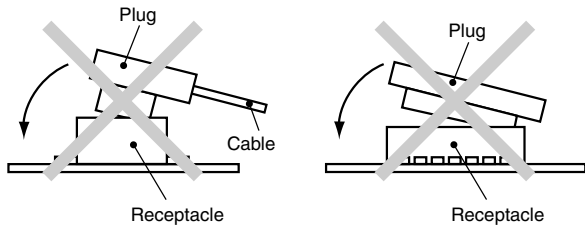

- Pushing the plug excessively when inserting it may deform and break the product.
- This product has a simple lock structure for mating. However, connectors may become unmated due to cable weight, cable reactive force, and impact by dropping, etc. Please take measures to prevent inadvertent connector disconnections at the equipment side.
- When removing the connector, do not pull the cable to avoid damaging the product.

Insert the tip of the removal jig under the flange of the plug and lift the jig straight up as shown below. (Removable from either the left or right side.) We recommend a tip thickness of 0.4 ± 0.03 mm (CS), 0.2 ± 0.03 mm (CF).

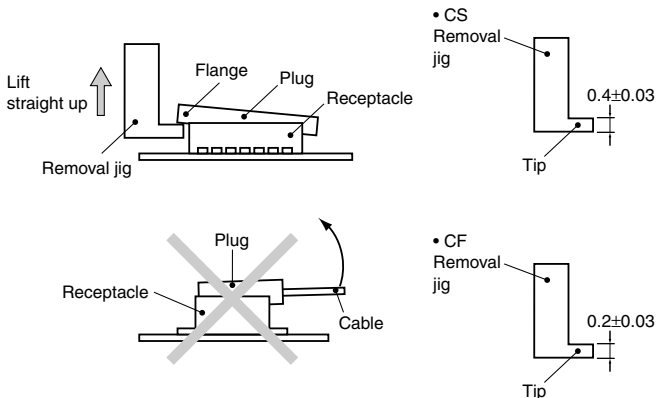

■ Other Notes

The connectors are not meant to be used for switching.

Please refer to the latest product specifications when designing your product.