

PART NUMBER
10118194-0001LF

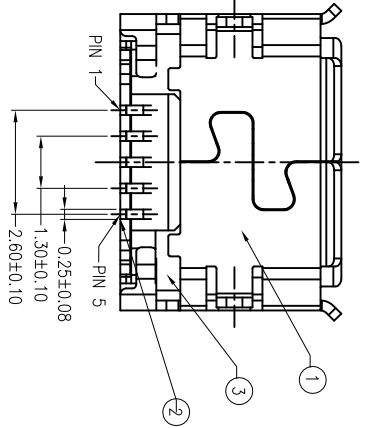
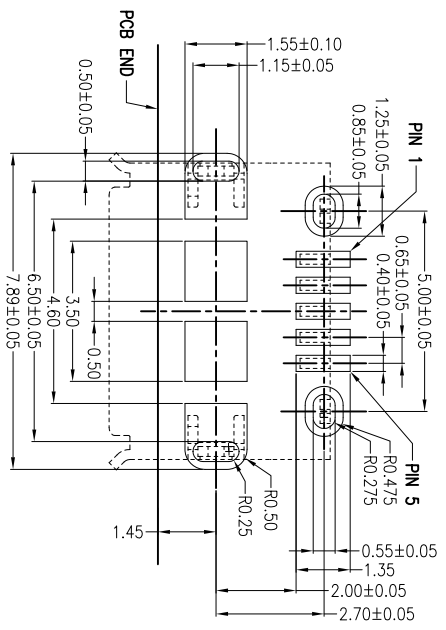
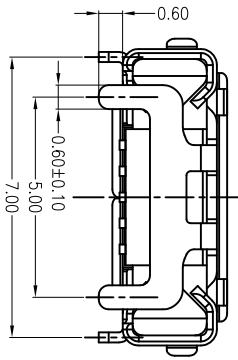
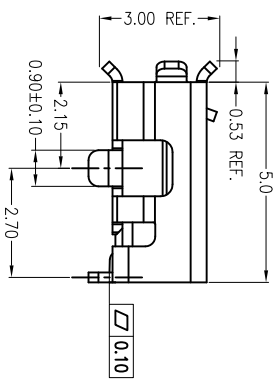
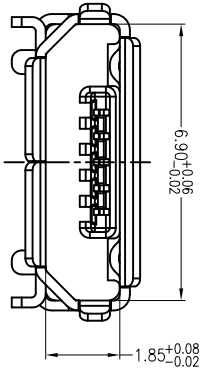
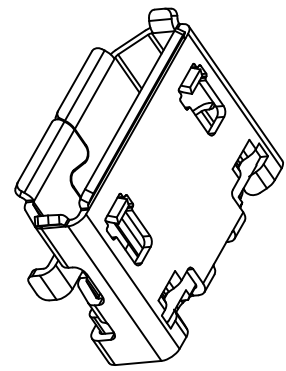
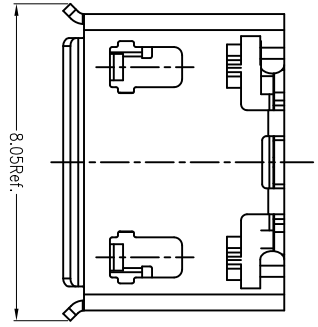

Item	Title	QTY
1	Shell	1
2	Terminal	5
3	InsertMolding	1

mat'l. code				surface				tolerance				projection				product family			
lfr	ecn no	dr	date	ASME Y14.5				ASME Y14.5				MM				USB			
A		LS	10/21/11	tolerances unless otherwise specified				.X±0.38				MICRO USB B TYPE RECEPTACLE							
				angles				.XX±0.25				scale							
				X°±2°				.XXX±0.10				dwg no							
				dr				JASON HSU 05/21/11				10118194							
				engr				JASON HSU 05/21/11				sheet 1 of 1							
				chr				JASON HSU 05/21/11				A4							
				appd				GARY HSIEH 05/21/11				CUSTOMER Drawing							
Sheet Index				revision															
Sheet				Sheet				A											
1				1															