

## WEATHER click

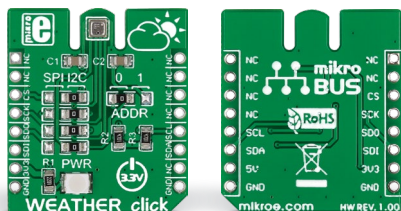

### 1. Introduction

Weather click carries the **BME280** integrated environmental unit from *Bosch*. It's a sensor that detects humidity, pressure and temperature, specifically designed for low current consumption and long term stability. Those features make it ideal for applications like home automation control, personalized weather stations, sport and fitness tools and so on. Weather click can communicate with the target MCU either through mikroBUS™ SPI or I<sup>2</sup>C interfaces. The board is designed to use a 3.3V power supply.

### 2. Soldering the headers

Before using your click board™, make sure to solder 1x8 male headers to both left and right side of the board. Two 1x8 male headers are included with the board in the package.

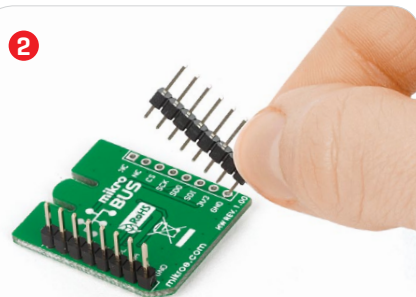
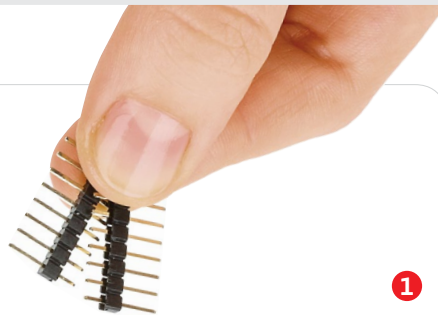

Turn the board upside down so that the bottom side is facing you upwards. Place shorter pins of the header into the appropriate soldering pads.

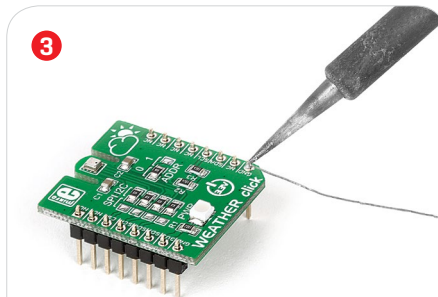

Turn the board upward again. Make sure to align the headers so that they are perpendicular to the board, then solder the pins carefully.

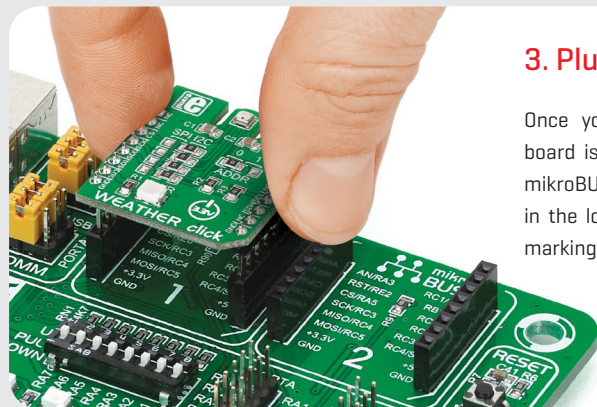

### 3. Plugging the board in

Once you have soldered the headers your board is ready to be placed into the desired mikroBUS™ socket. Make sure to align the cut in the lower-right part of the board with the markings on the silkscreen at the mikroBUS™ socket. If all the pins are aligned correctly, push the board all the way into the socket.

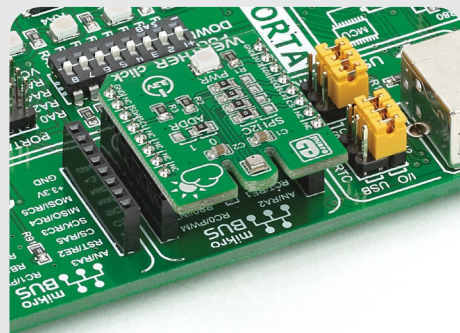

### 4. Essential features

The BME280 IC has high accuracy and reliability for all three sensors. The humidity sensor has a response time of just one second and it's accurate up to  $\pm 3\%$  RH. The pressure sensor has sensitivity error of  $\pm 0.25\%$  which is equivalent to 1m at 400m height change]. The humidity and pressure sensors can operate independently from each other. Finally, the temperature sensor has a high resolution [up to 20 bit, when IIR filter is enabled] and low noise. The chip has three operating modes: sleep, forced, and normal.

**click**  
BOARD™  
[www.mikroe.com](http://www.mikroe.com)



Weather click manual  
ver 1.00



010000085035

## 5. Schematic

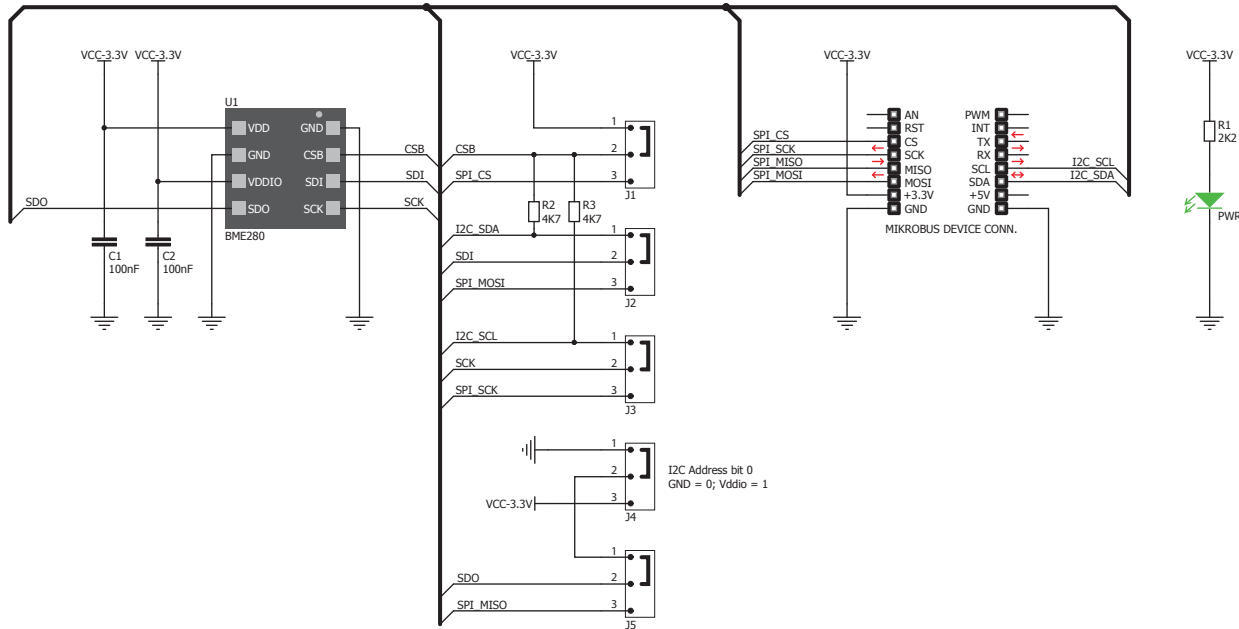

## 6. Dimensions

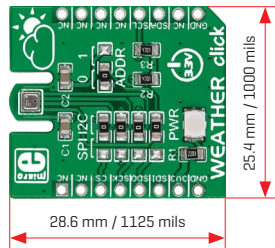

	mm	mils
LENGTH	28.6	1125
WIDTH	25.4	1000
HEIGHT*	3.3	130

\* without headers

## 7. SMD jumpers

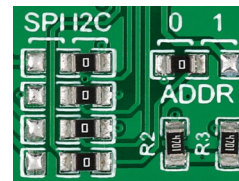

*Weather click* features a set of jumpers for switching between

SPI and I<sup>2</sup>C interfaces. If set to I<sup>2</sup>C, there's an additional jumper for selecting the address.

## 8. Code examples

Once you have done all the necessary preparations, it's time to get your click board™ up and running. We have provided examples for mikroC™, mikroBasic™ and mikroPascal™ compilers on our **Libstock** website. Just download them and you are ready to start.



## 9. Support

MikroElektronika offers **free tech support** [[www.mikroe.com/support](http://www.mikroe.com/support)] until the end of the product's lifetime, so if something goes wrong, we're ready and willing to help!



## 10. Disclaimer

MikroElektronika assumes no responsibility or liability for any errors or inaccuracies that may appear in the present document. Specification and information contained in the present schematic are subject to change at any time without notice.

Copyright © 2015 MikroElektronika. All rights reserved.