

# MHPS SERIES KEY SWITCHES

## FEATURES

- Double pole - double throw and 4 pole - double throw configurations.
- Momentary (non-locking) and maintained action (locking) models.
- Shorting and non-shorting contacts.
- Audible ('click') and non-audible action models.

### GENERAL SPECIFICATIONS

Contact rating:	100 mA @ 30 VDC
Insulation resistance:	100 megohms minimum at 500 VDC
Dielectric withstanding voltage:	500 VAC for 1 minute
Contact resistance:	100 milliohms maximum
Life:	10,000 cycles minimum
Operating temperature range:	-20°C to +65°C

### SOLDERING

Wave soldering:	260°C max. for 5 seconds maximum
Manual soldering:	350°C ± 10°C for 3 seconds maximum
Solvent washing:	Non-washable.

### MATERIALS

Case:	PBT (model MHPS2266 only - Type 6/6 nylon)
Cover:	Acetal (model MHPS2266 only - Type 6/6 nylon)
Actuator:	Acetal
Terminals:	Silver plated brass
Shorting Contact:	Silver plated phosphor bronze

SPECIFICATIONS SUBJECT TO CHANGE WITHOUT NOTICE.

#### US # MHPS2266

Travel: full-.075" (1.9mm)  
to lock-.039" (1mm)  
Operating force: 140±50g



#### DOUBLE POLE

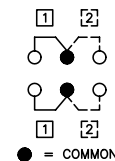
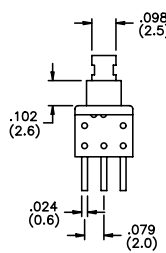
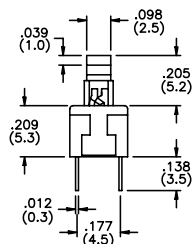
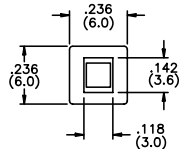

SCHEMATIC

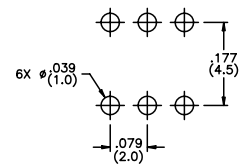

P.C. board layout

US Model No.	Action	Contacts	Audible
<b>MHPS2266</b>	maint'd.	non-sh't'g.	no
<b>MHPS2266N</b>	mom.	non-sh't'g.	no

#### US # MHPS2273 EU # PHAP4673

Travel: full-.071" (1.8mm)  
to lock-.039" (1mm)  
Operating force: 200gf ± 50gf



#### DOUBLE POLE

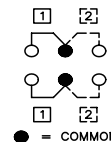
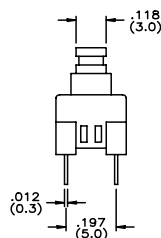
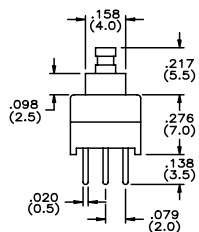
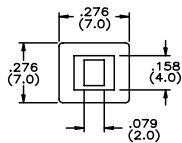

SCHEMATIC

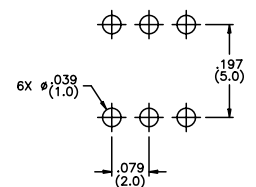

P.C. board layout

US Model No.	Action	Contacts	Audible	EU Model No.
<b>MHPS2273</b>	maint'd.	non-sh't'g.	no	<b>PHAP4673</b>
<b>MHPS2273N</b>	mom.	non-sh't'g.	no	N/A

**US # MHPS2283**  
**EU # PHAP4683W**

Travel: full-.098" (2.5mm)  
to lock-.059" (1.5mm)  
Operating force: 180±50g



**DOUBLE POLE**

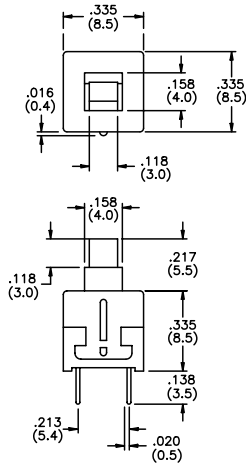

US Model No.	Action	Contacts	Audible	EU Model No.
<b>MHPS2283</b>	maint'd.	non-sht'g.	yes	<b>PHAP4683W</b>
<b>MHPS2283N</b>	mom.	non-sht'g.	no	N/A
<b>MHPS2283V</b>	mom.	non-sht'g.	yes	<b>PHAP4383V</b>

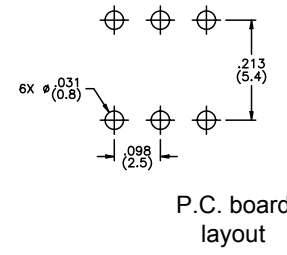
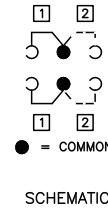

**US # MHPS2285**

Travel: full-.098" (2.5mm)  
to lock-.059" (1.5mm)  
Operating force: 180±50g



**DOUBLE POLE**

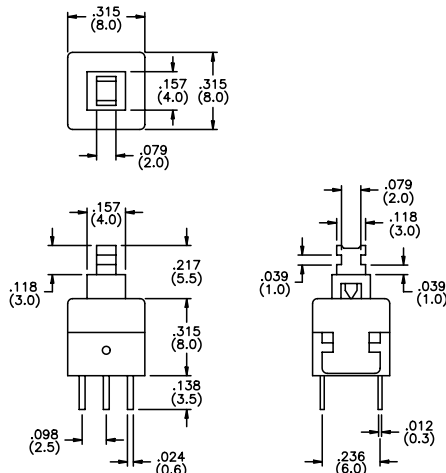

Model No.	Action	Contacts	Audible
<b>MHPS2285</b>	maint'd.	non-sht'g.	yes
<b>MHPS2285N</b>	mom.	non-sht'g.	no
<b>MHPS2285V</b>	mom.	non-sht'g.	yes

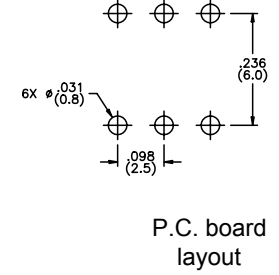
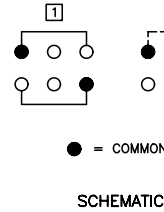

**US # MHPS4284**

Travel: full-.098" (2.5mm)  
to lock-.059" (1.5mm)  
Operating force: 180g  
+100g, -50g



**FOUR POLE**

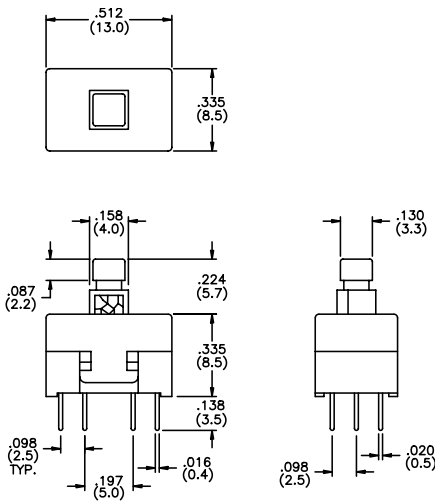

Model No.	Action	Contacts	Audible
<b>MHPS4284</b>	maint'd.	non-sht'g.	no
<b>MHPS4284N</b>	mom.	non-sht'g.	no
<b>MHPS4284V</b>	mom.	non-sht'g.	yes

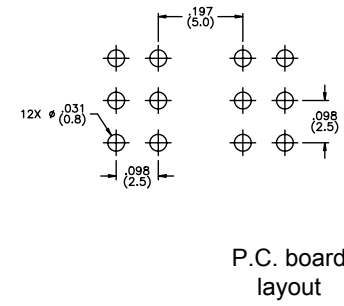
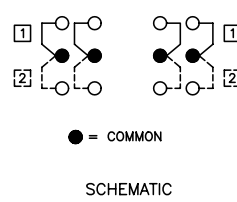

**CAPS** (fit MHPS2273, MHPS2283 and MHPS2285 models only)

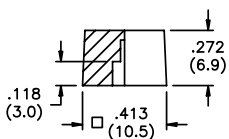

**MH1** Square cap

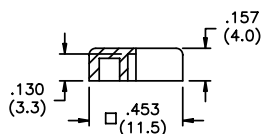

**U4520** Square cap

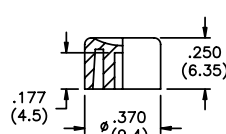

**U4530** Round cap

Note - add digit from table to cap part number for color.  
Example - **MH12** indicates black cap.

No.	Color
1	blue
2	black
3	green
5	yellow
6	red
7	ivory

SPECIFICATIONS SUBJECT TO CHANGE WITHOUT NOTICE.