

DETAILS

Product Number	CA12536_HEIDI-M
Family	Heidi
Type	Assembly
Color	clear
Diameter	21,6 mm
Height	11,7 mm
Style	round
Optic Material	PMMA
Holder Material	
Fastening	tape, pin
Status	production ready
ROHS Compliant	Yes
Date Updated	3/01/2017



OPTICAL PROPERTIES

LED	Viewing	Light	Effi-	cd/lm	Connector
	Angle	Beam	ciency		
XP-L	28 deg	Medium	86 %	2.800	-
XHP35 HD	28 deg	Medium	86 %	3.110	-
XHP35 HI	28 deg	Medium	87 %	3.700	-
LUXEON Rebel ES	29 deg	Medium	88 %	3.400	-
LUXEON A	29 deg	Medium	88 %	3.400	-
LUXEON R	29 deg	Medium	87 %	3.200	-
LUXEON Rebel	27 deg	Medium	88 %	3.700	-
NWSx229A	27 deg	Medium	85 %	2.900	-
NVSW3x9A	28 deg	Medium	92 %	2.900	-
Oslon SSL 150	27 deg	Medium	88 %	3.900	-
Oslon Black Flat	sim: 29	Medium	sim: 94 %	sim: 3.800	-
Z8Y22P	27 deg	Medium	93 %	3.100	-

Relative intensity of CA12536_HEIDI-M_(XHP35_HD)

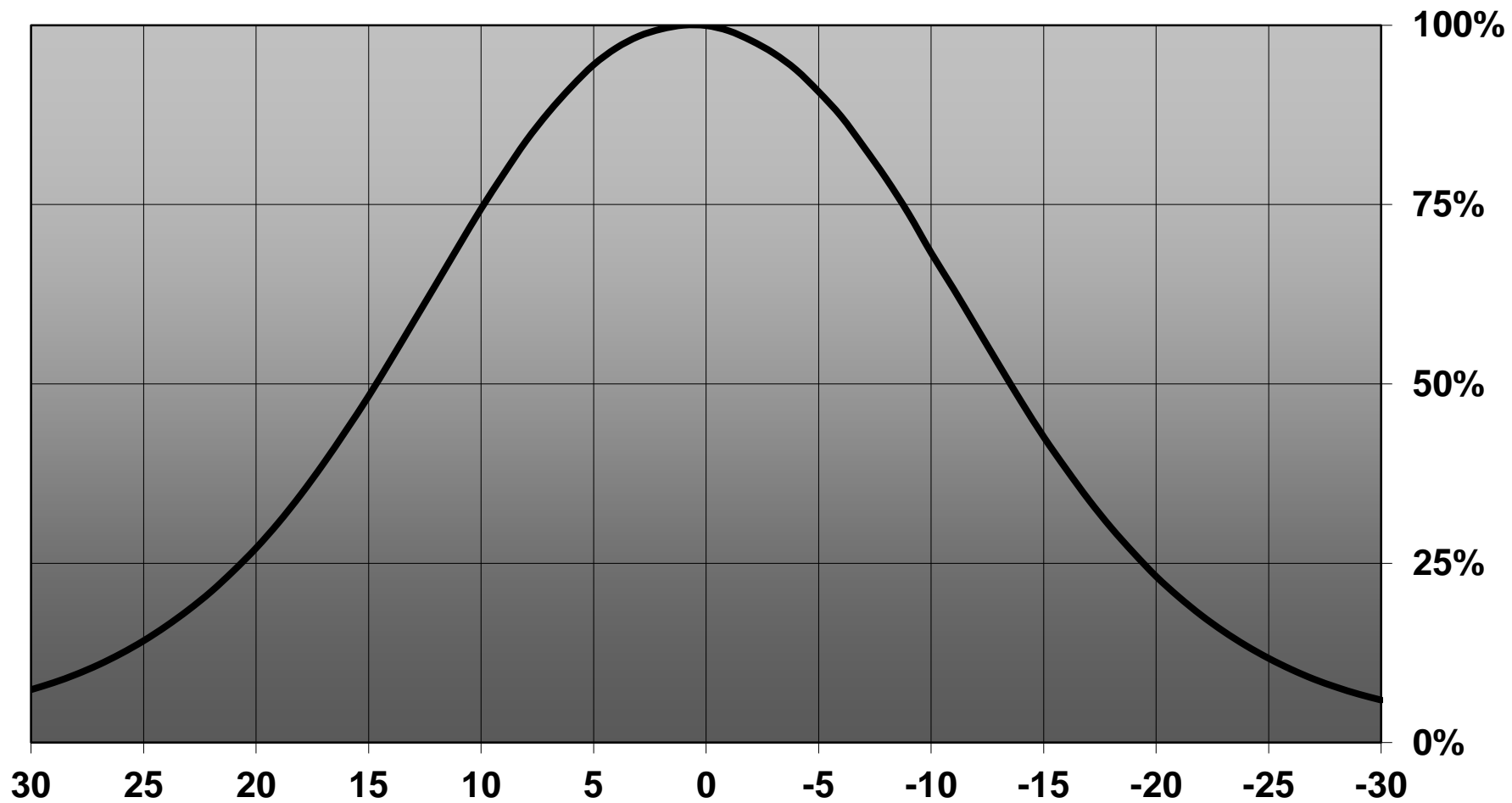

Relative intensity of CA12536_HEIDI-M_(XPH35_HI)

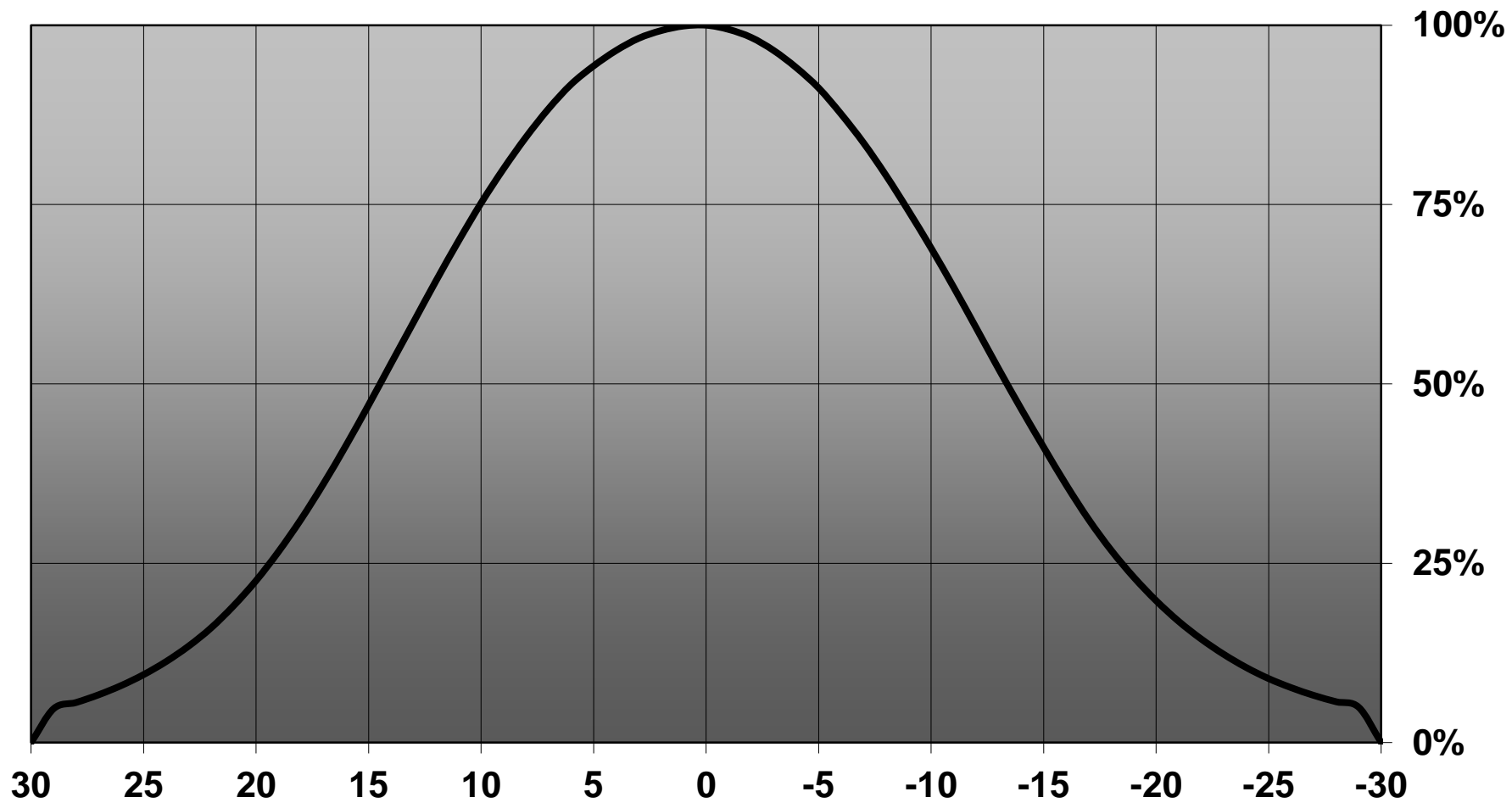

D

C

B

A

4

4

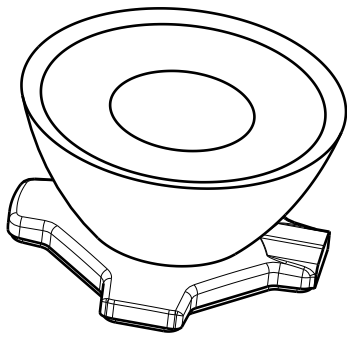

Isometric view

Ø 21.6

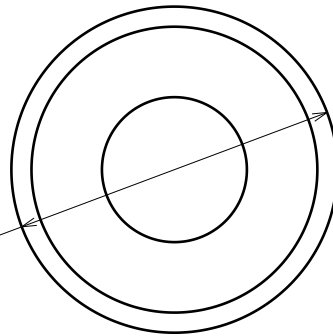

Top view

3

3

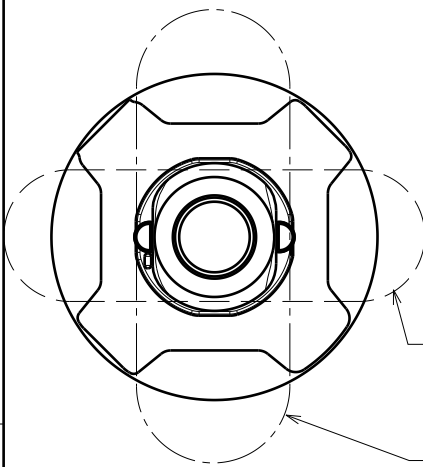

Bottom view
OVAL BEAM direction

Heidi-0

Heidi-0-90

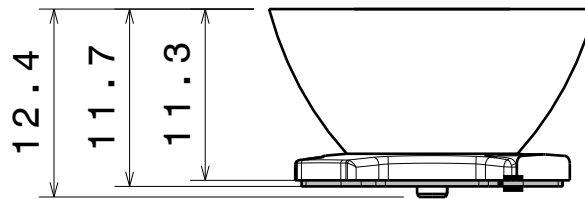

Front view

2

2

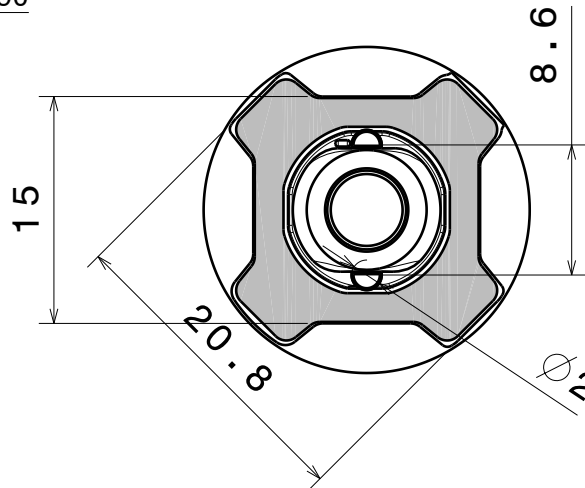

8.6 Between pin midpoints

Bottom view

Material:
Lens PMMA
Tape PU Foam

This drawing is our property.
It can't be reproduced
or communicated without
our written agreement.



Ledil Oy
Salorankatu 10
FIN-24100 SALO
Finland

DRAWING TITLE

Datasheet Heidi-Series Assy

DRAWN BY
ah

DATE
1.2.2012

CHECKED BY

DATE

SIZE
A4

DRAWING NUMBER

REV
2

DESIGNED BY

DATE

SCALE 2:1 WEIGHT (g)

SHEET 1/1

D

A

1

1

Luminaire: LEDiL Oy CA12536_HEIDI-M_(XP-L) Eff.86.0%
Lamps: 1 x Cree_XP-L_127.813lm@250mA_P=0.73723W_I=249.9mA

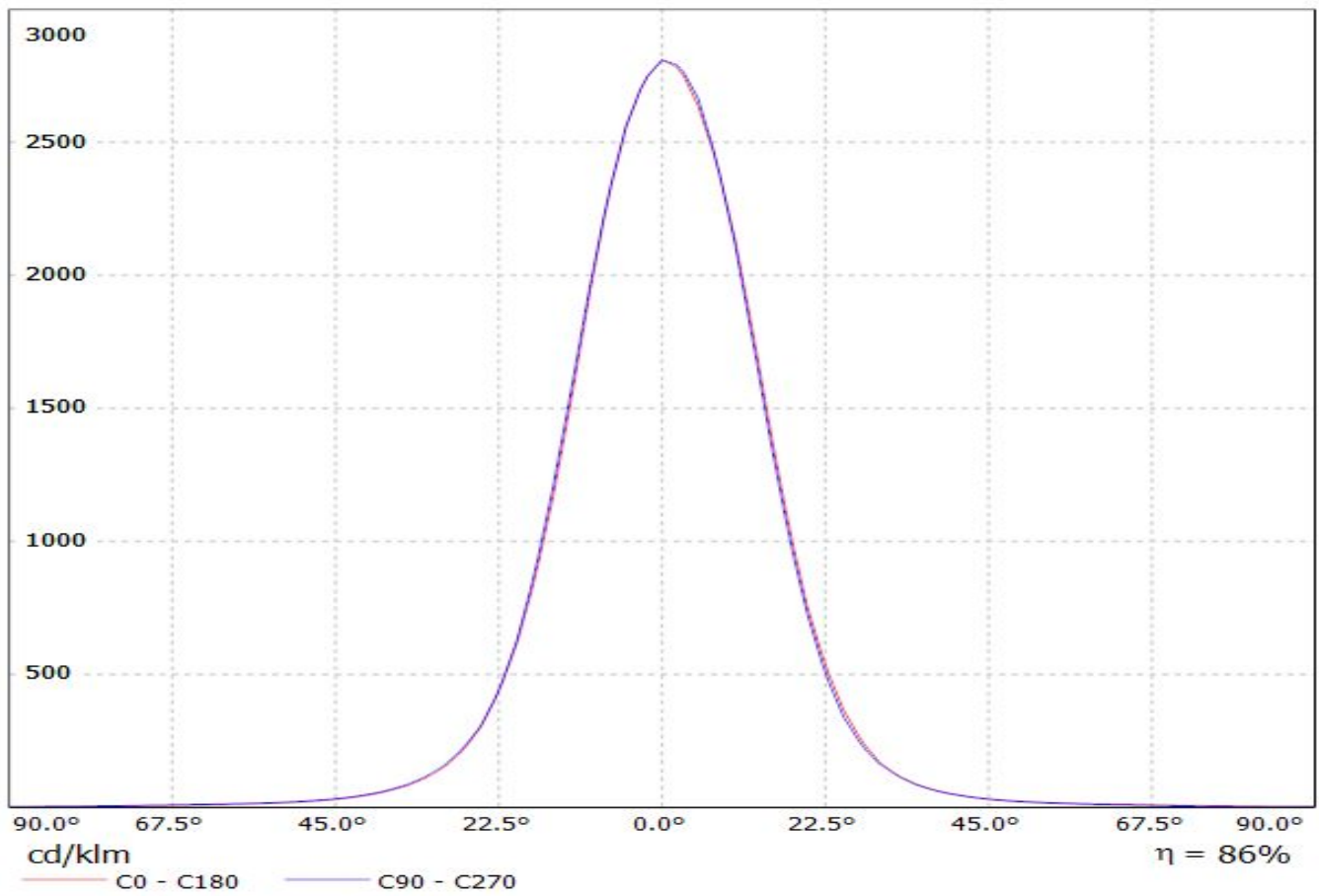

Luminaire: Ledil Oy CA12536_HEIDI-M_(XHP35_HD)_SIMULATED
Lamps: 1 x Cree XHP35 HD

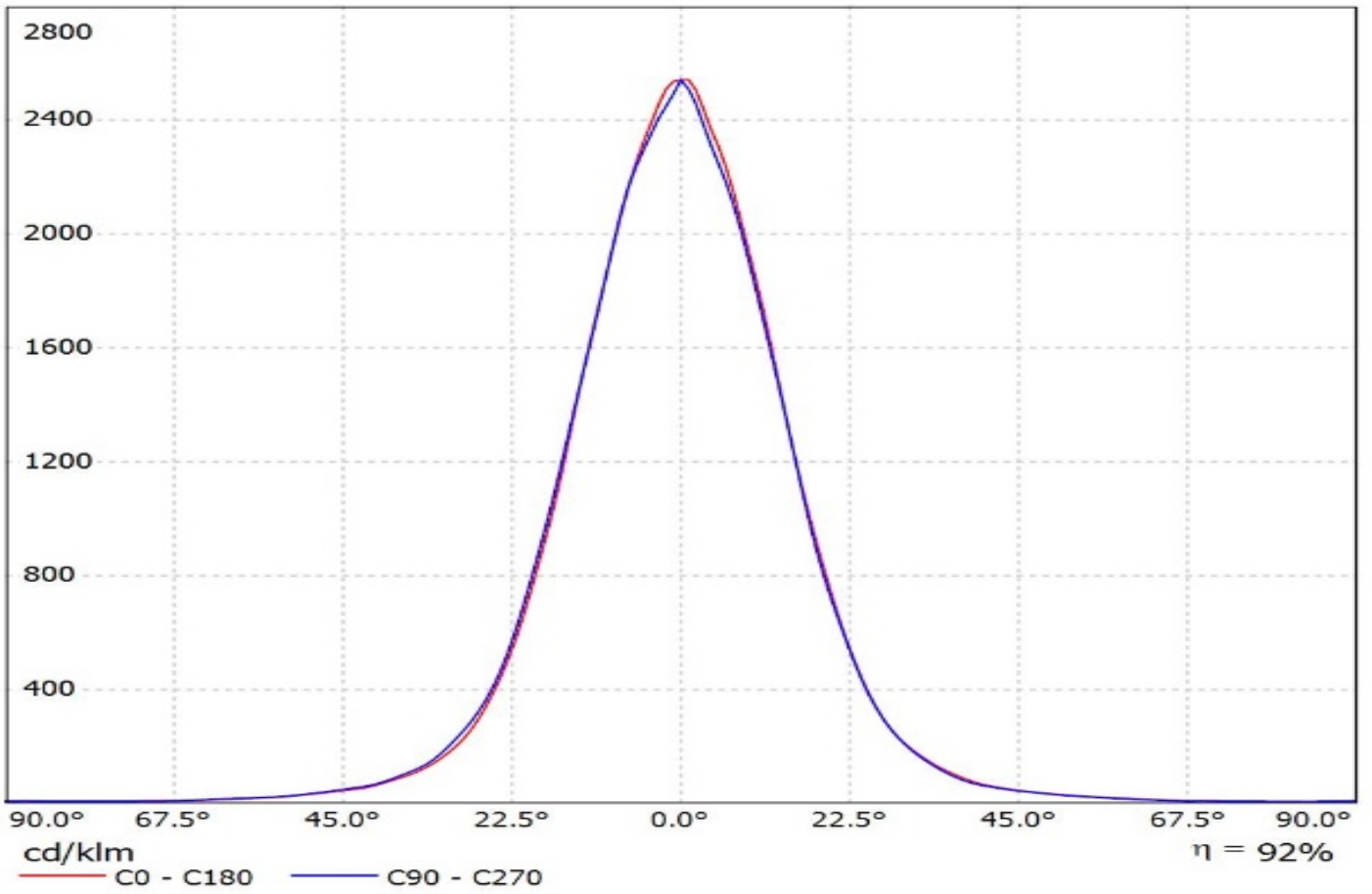

Luminaire: Ledil Oy CA12536_HEIDI-M_(Luxeon-Rebel-ES) Efficiency=88%
Lamps: 1 x Luxeon Rebel ES 92lm@250mA CCT=4094K P=0.7W I=250mA

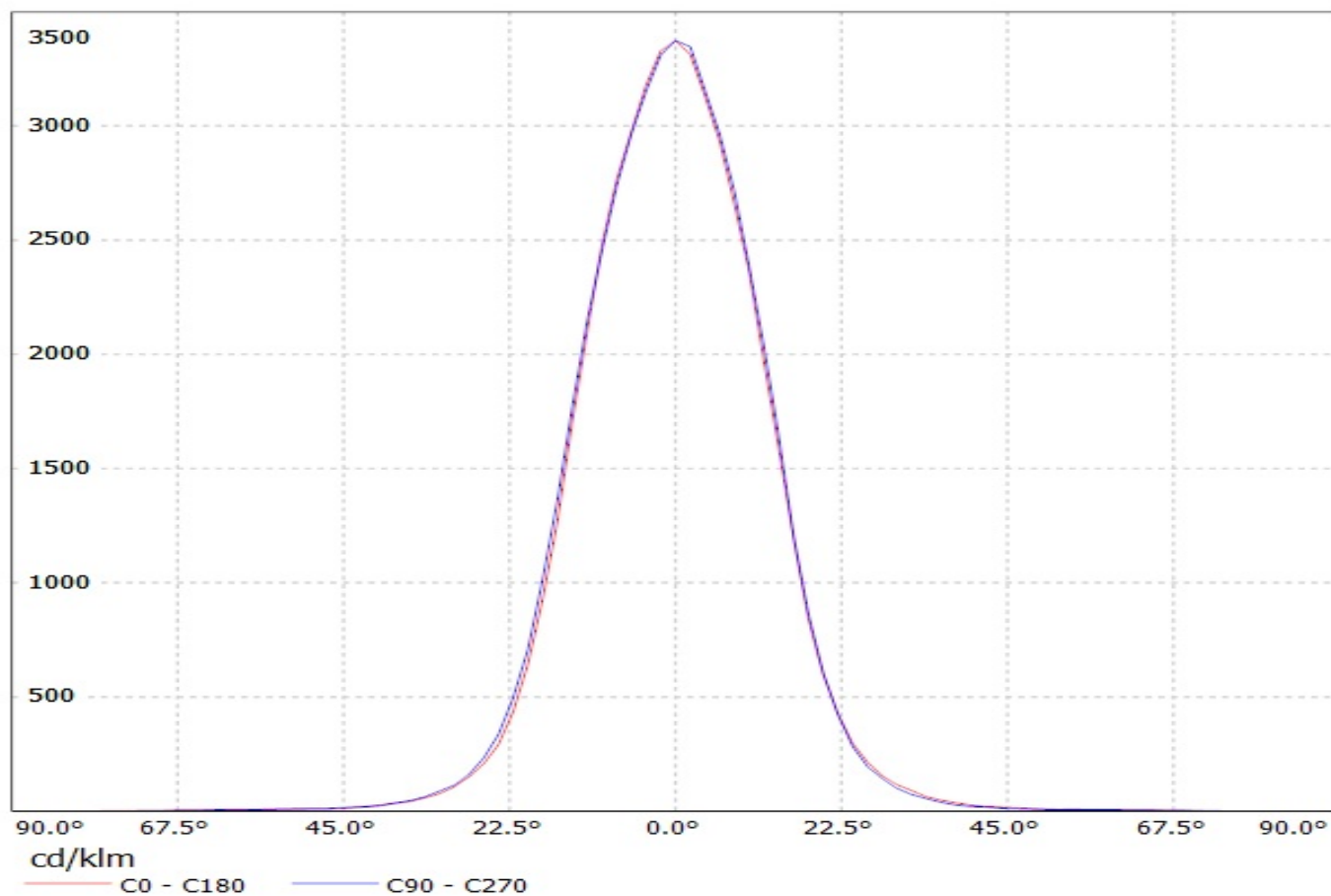

Luminaire: Ledil Oy CA12536_HEIDI-M_(Luxeon-A) Efficiency=88%
Lamps: 1 x Luxeon A 64lm@250mA CCT=2933K P=0.7W I=250mA

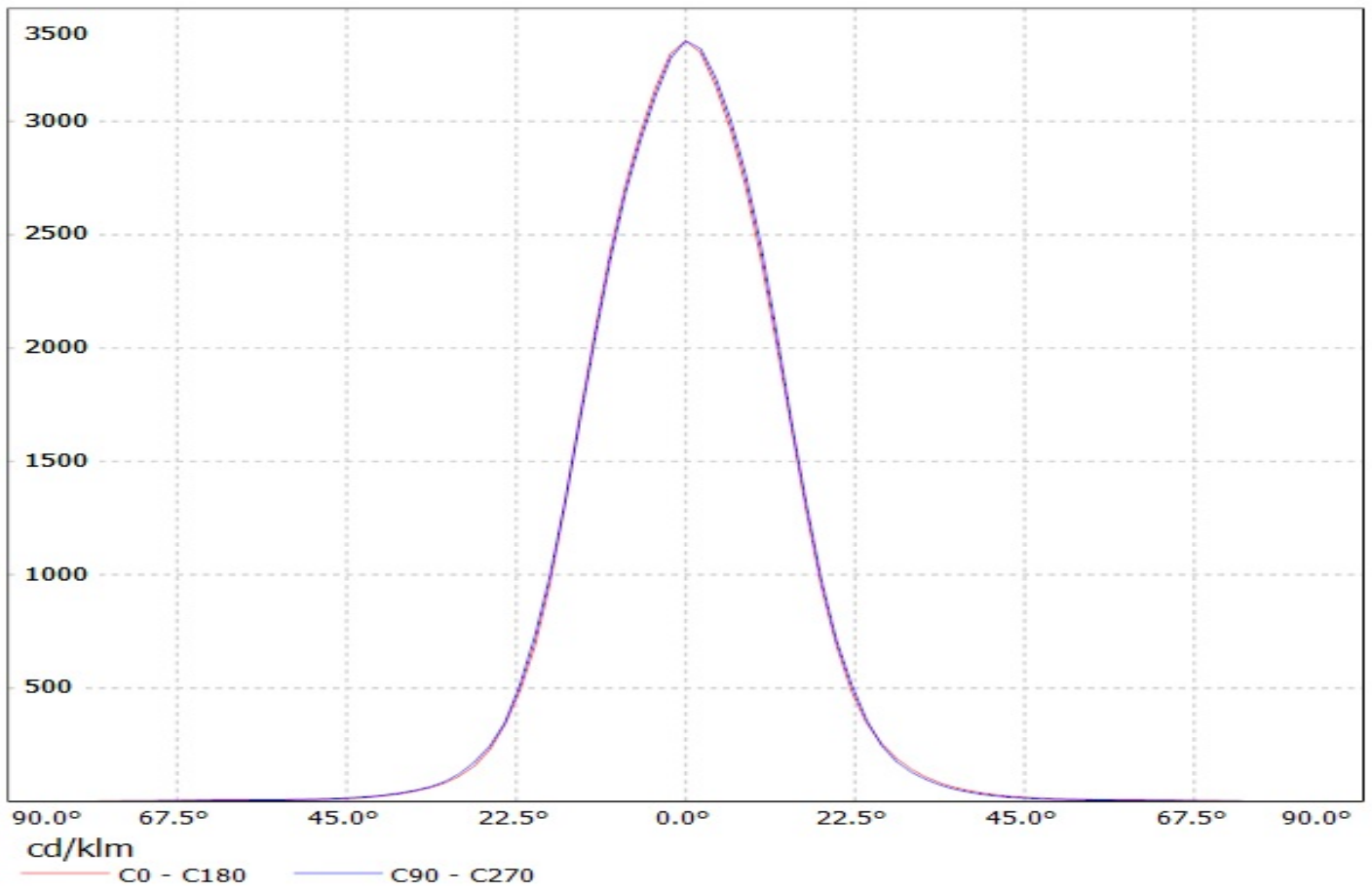

Luminaire: Ledil Oy CA12536_HEIDI-M_(Luxeon-R) Efficiency=87%
Lamps: 1 x Luxeon R 85lm@250mA CCT=4328K P=0.7W I=250mA

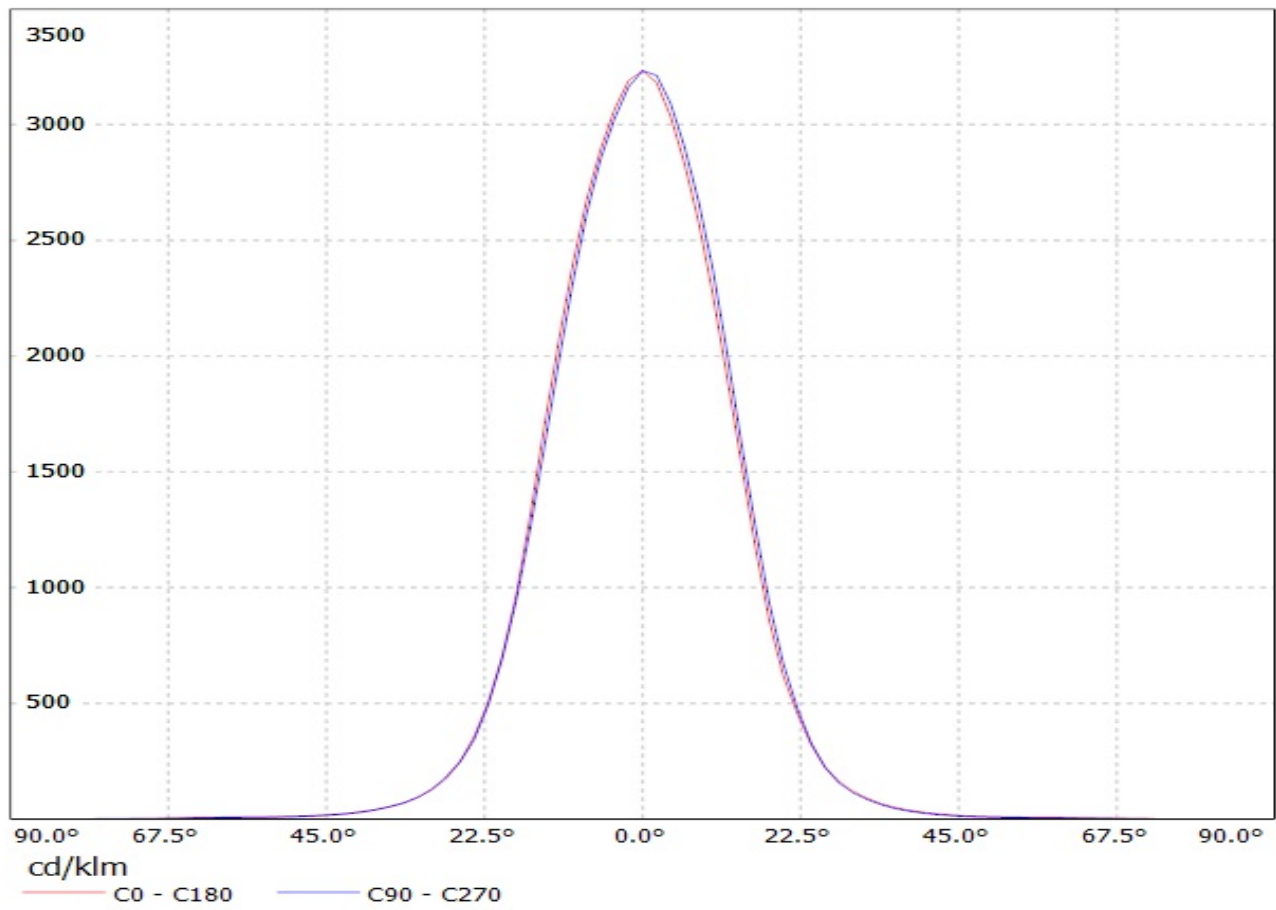

Luminaire: LEDiL Oy CA12536_HEIDI-M_(Luxeon_Rebel)

Lamps: 1 x Luxeon_Rebel_(LXM8-PW30)_61.9761lm@250mA_P=0.729_I=250mA

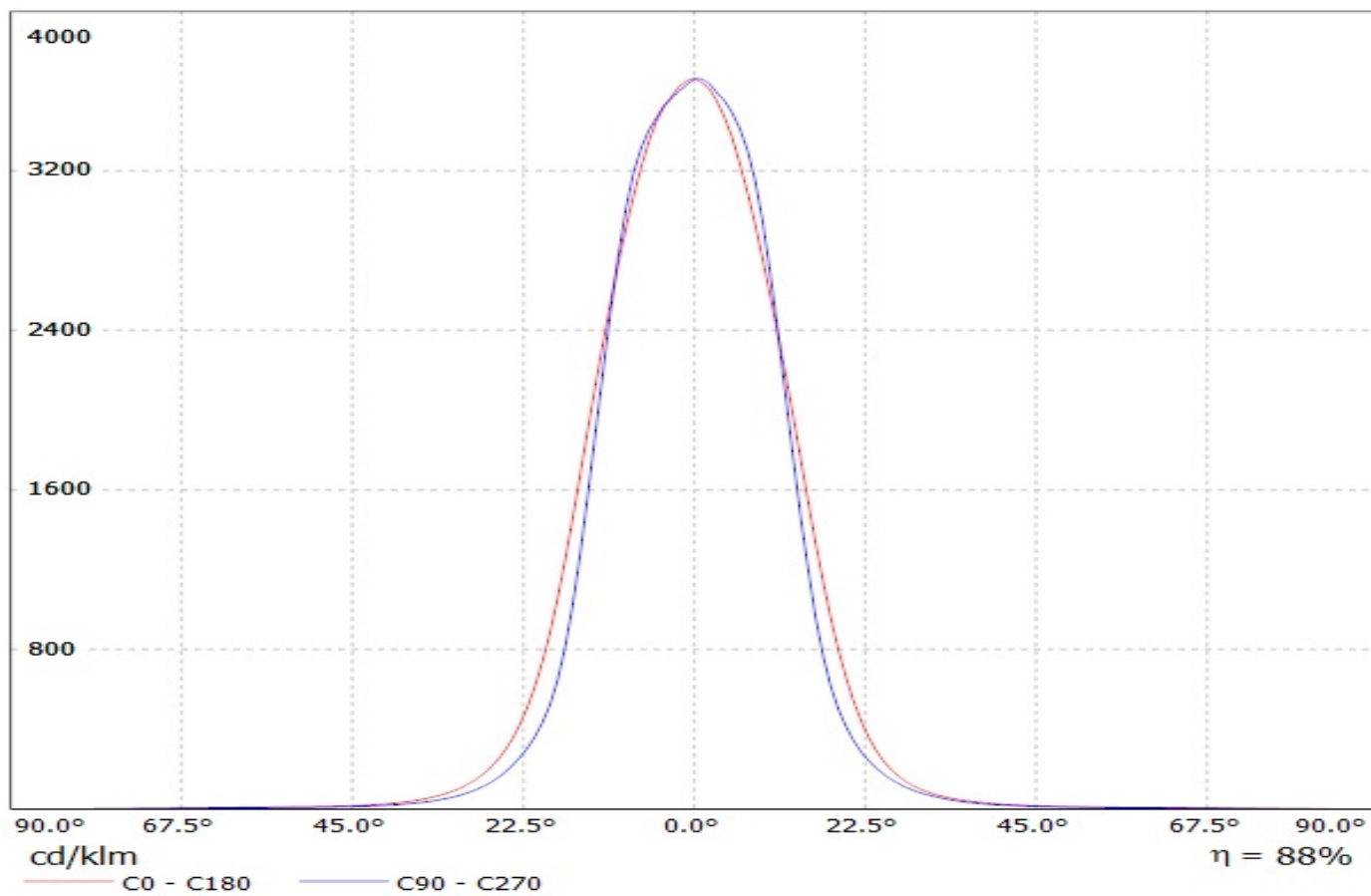

Luminaire: LEDiL Oy CA12536_HEIDI_M_(NWSL229AE)

Lamps: 1 x Nichia_NWSL229AE_120.537lm@250mA_P=0.7126W_I=0.250A

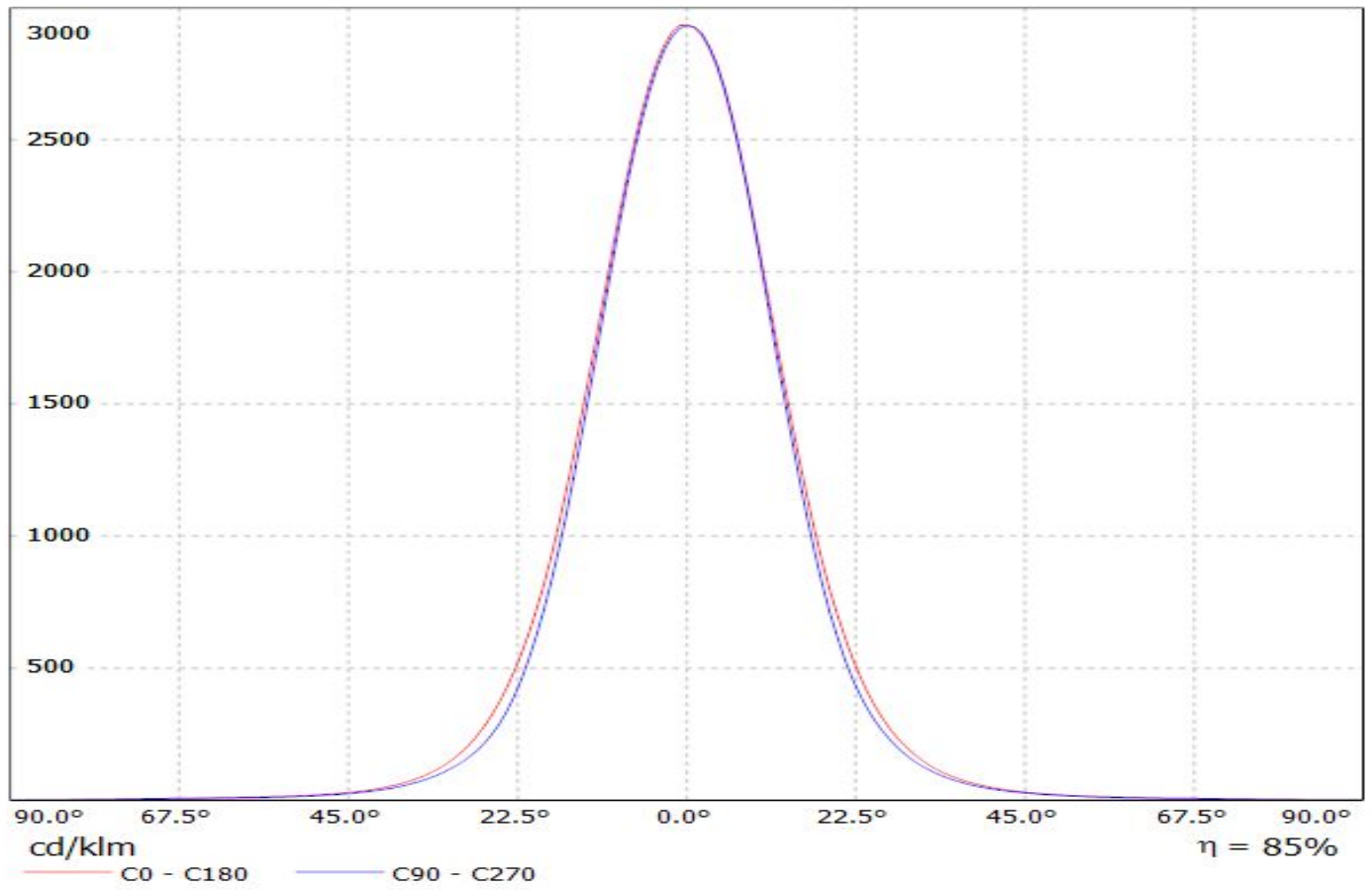

Luminaire: Ledil CA12536_HEIDI-M_(NVSW319AE)

Lamps: 1 x Nichia_NVSW319AE_(sm405D440f2L2R70)_126.795lm@250mA_P=0.73515W_I=0.250A

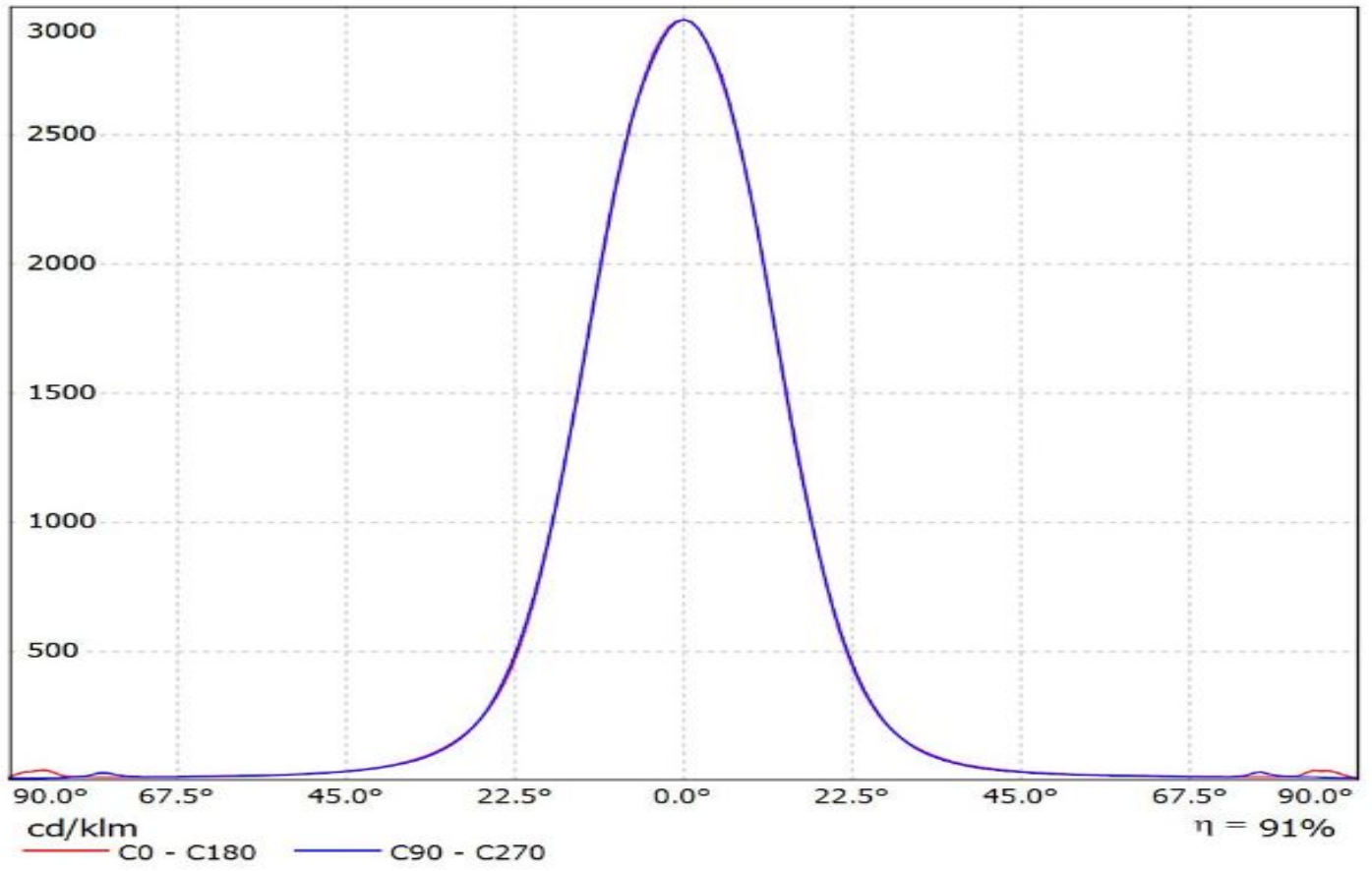

Luminaire: LEDiL Oy CA12536_HEIDI-M_(Oslon_SSL_150)
Lamps: 1 x Osram_Oslon_SSL_150_(LCW_CRUP.EC-KTLP-607Q-1)
_77.1485lm@250mA_P=0.744_I=250mA

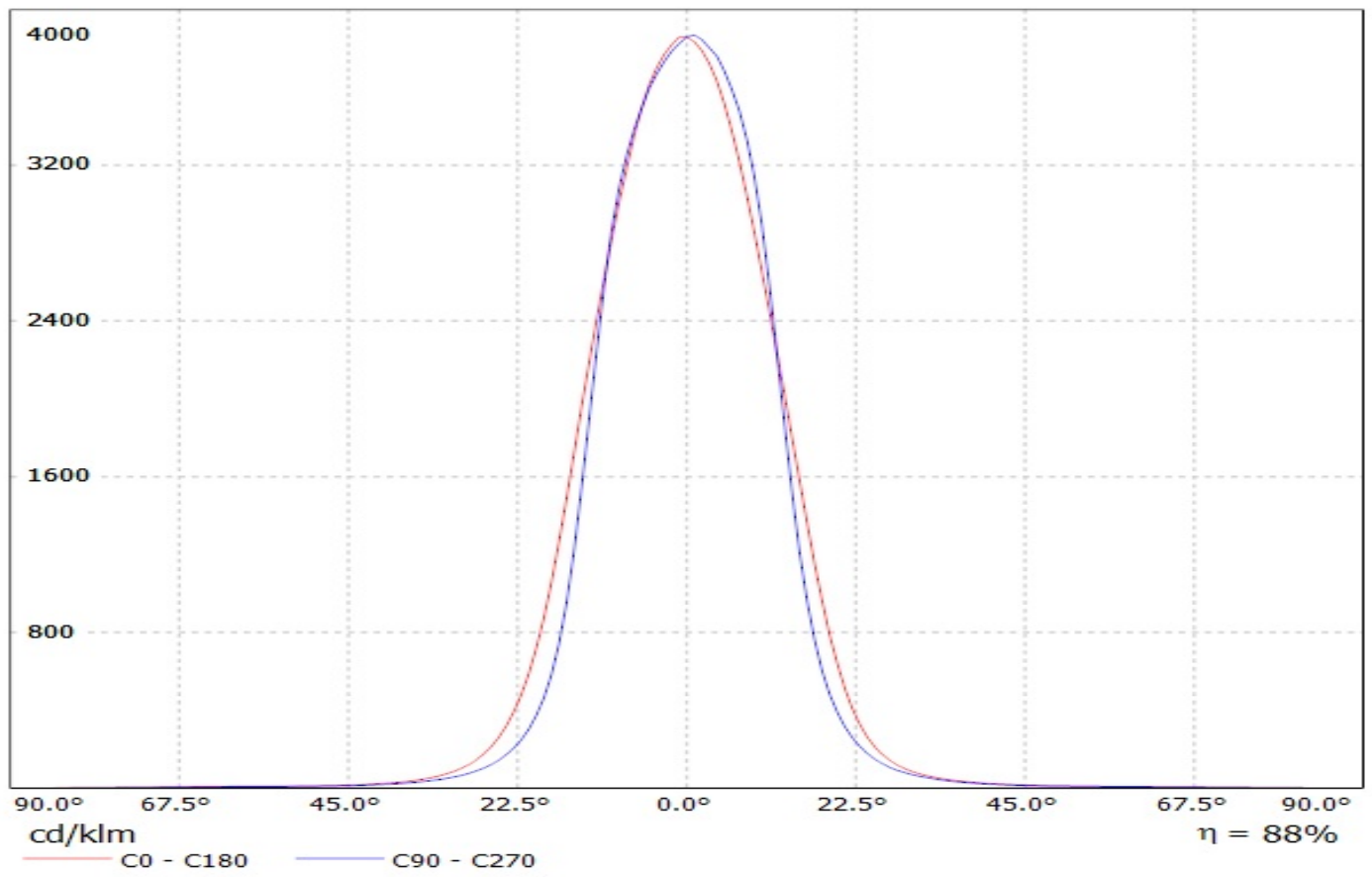

Luminaire: Ledil Oy CA12536_HEIDI-M_(Oslon_Black_Flat)_SIMULATED
Lamps: 1 x Osram Oslon Black Flat (LUV HWQP)

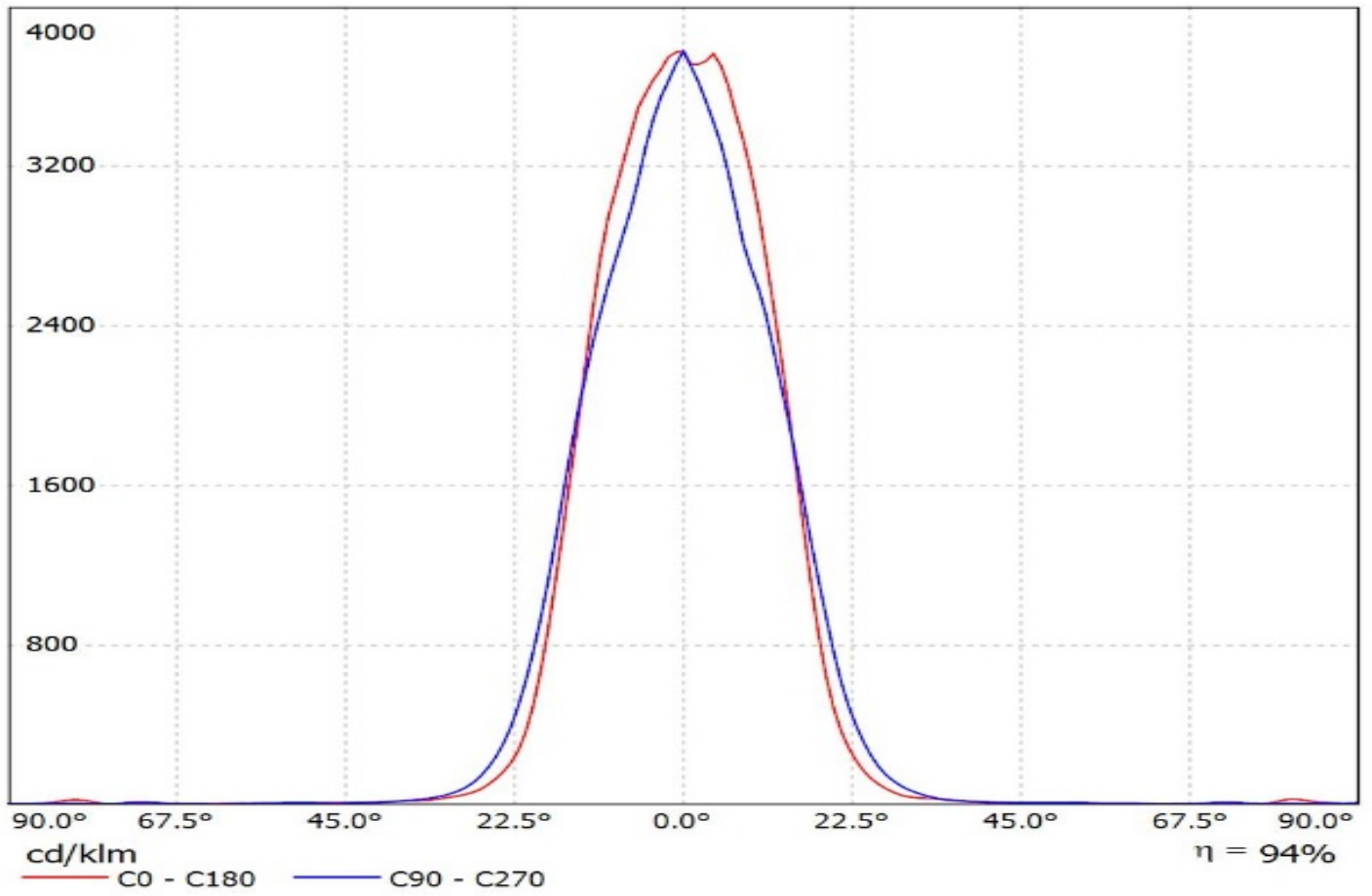

Luminaire: LEDiL Oy CA12536_HEIDI-M_(Z8Y22plus)
Lamps: 1 x Seoul_Z8Y22plus_(W6E2G)_125.652lm@250mA_P=0.69312W_I=0.250A

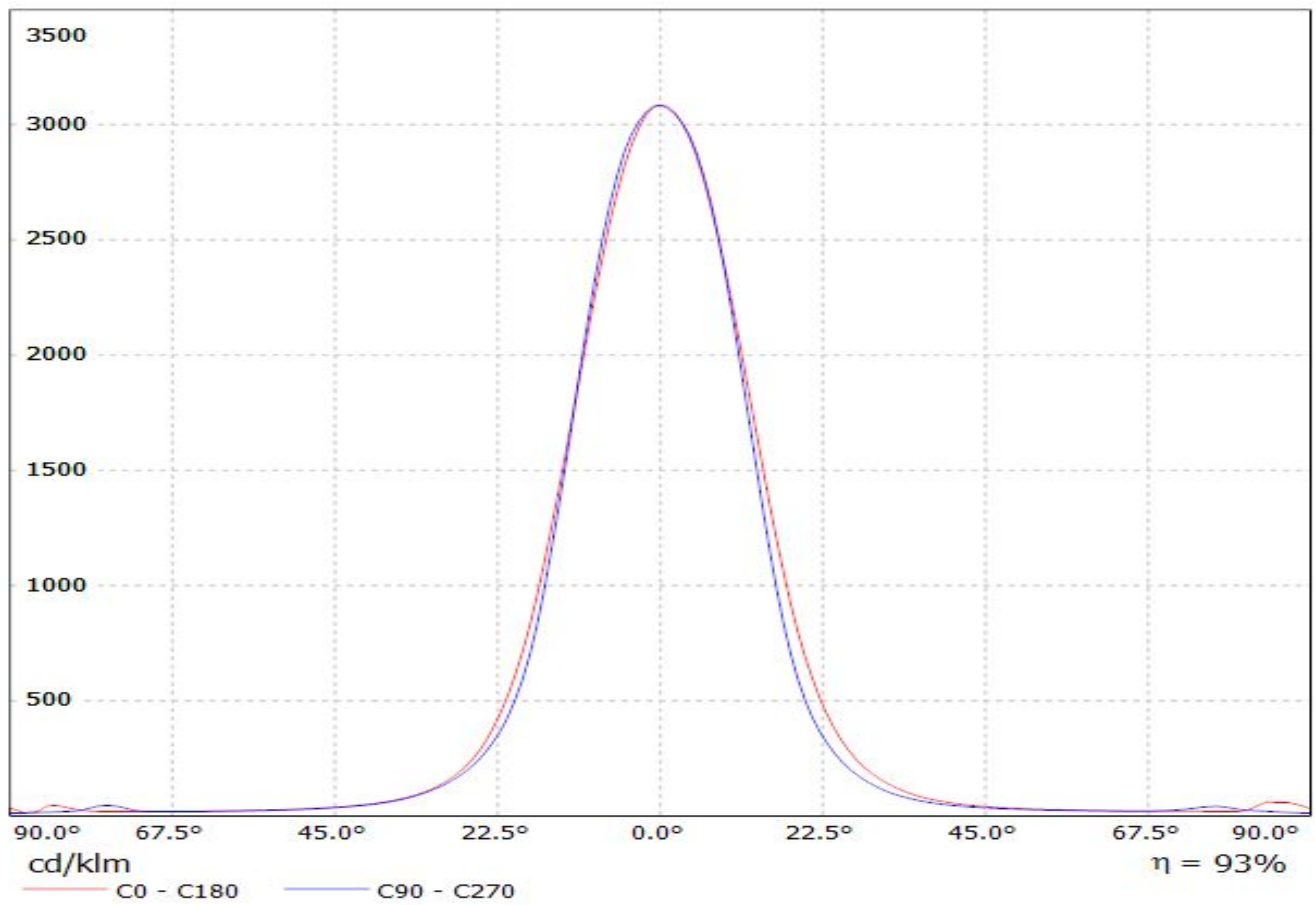

Luminaire: LEDiL Oy CA12536_HEIDI-M_(XP-L) Eff.86.0%
Lamps: 1 x Cree_XP-L_127.813lm@250mA_P=0.73723W_I=249.9mA

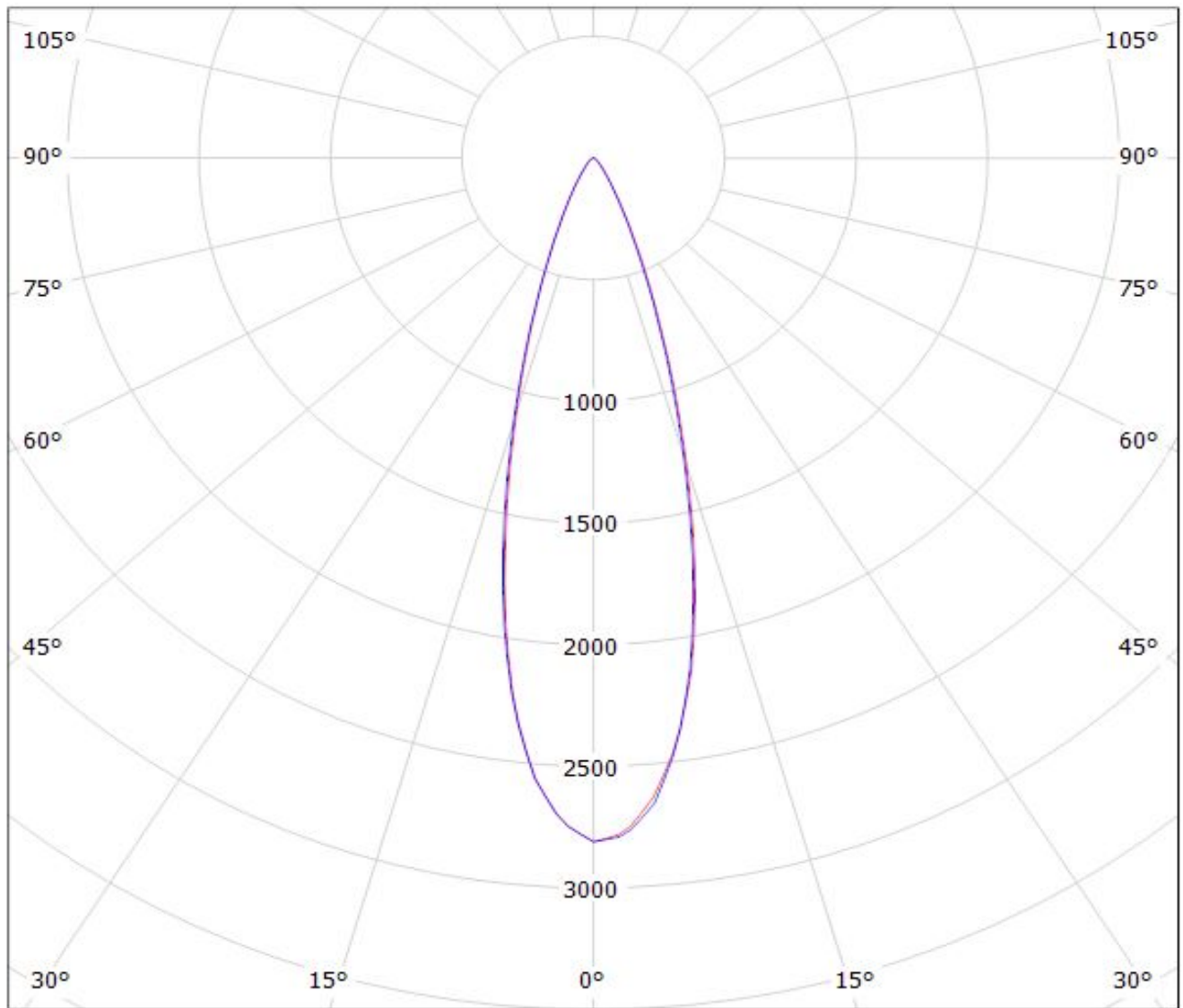

cd/klm

— C0 - C180 — C90 - C270

$\eta = 86\%$

Luminaire: Ledil Oy CA12536_HEIDI-M_(XHP35_HD)_SIMULATED
Lamps: 1 x Cree XHP35 HD

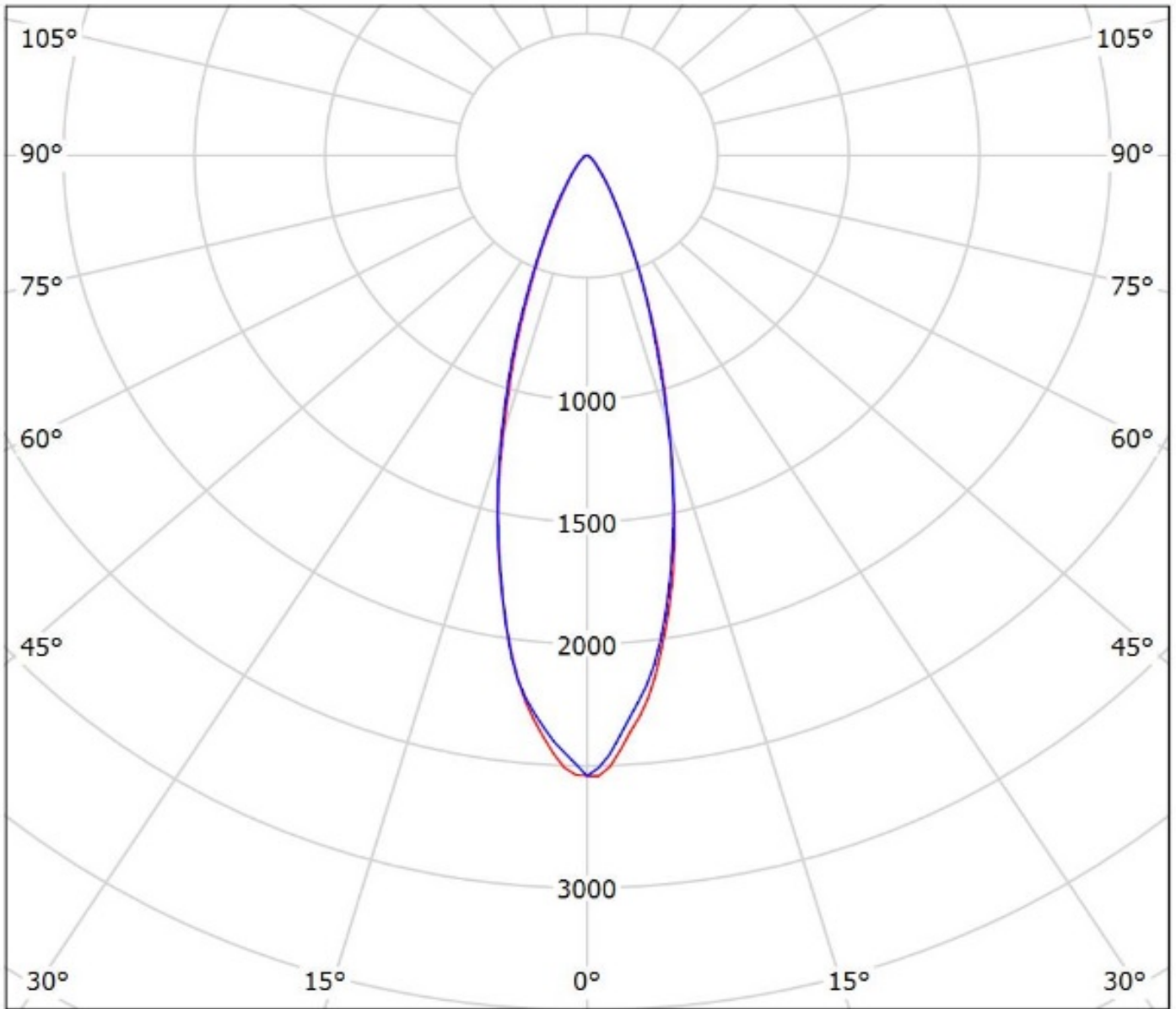

cd/klm
— C0 - C180 — C90 - C270

$\eta = 92\%$

Luminaire: Ledil Oy CA12536_HEIDI-M_(Luxeon-Rebel-ES) Efficiency=88%
Lamps: 1 x Luxeon Rebel ES 92lm@250mA CCT=4094K P=0.7W I=250mA

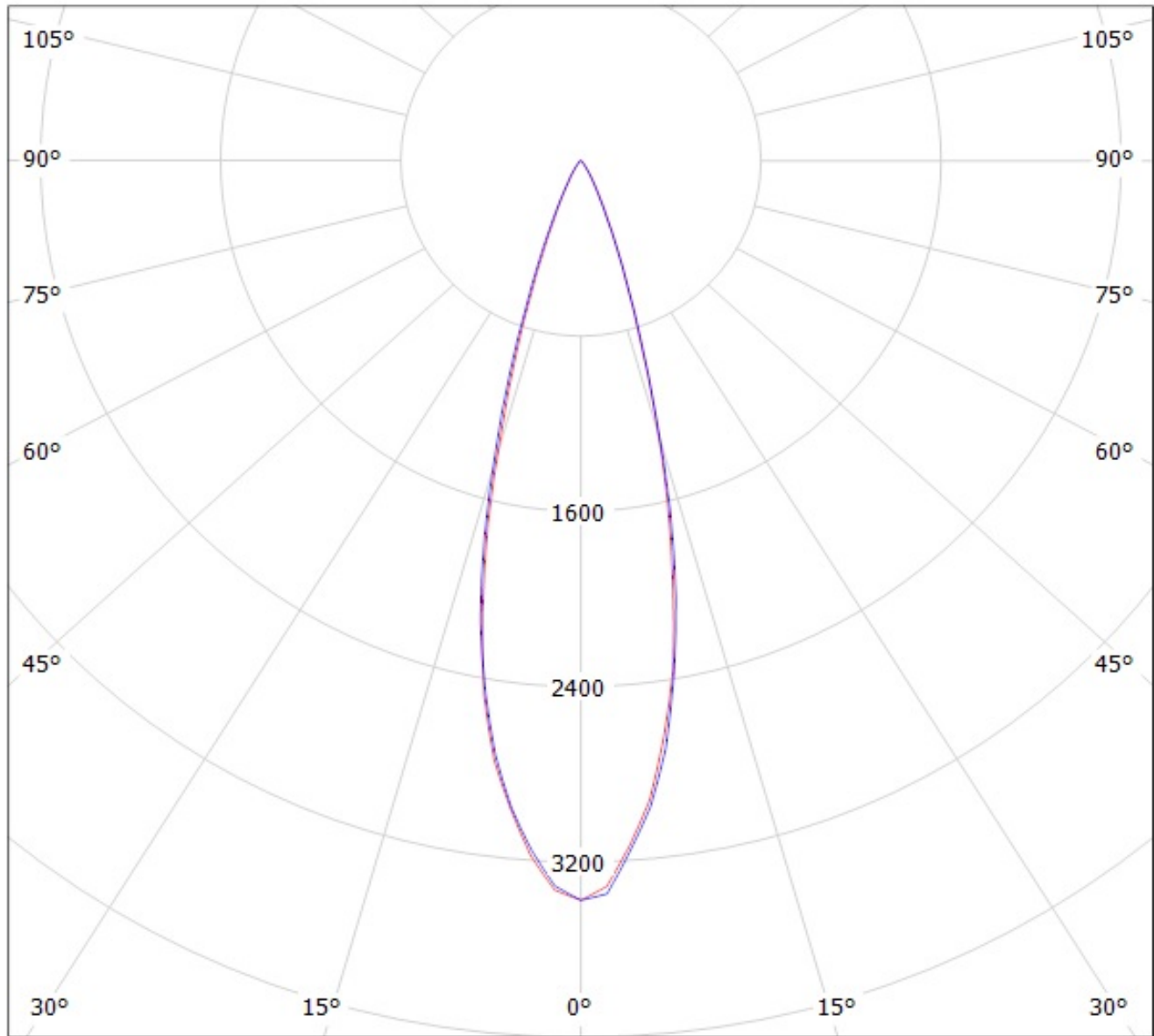

cd/klm

— C0 - C180

— C90 - C270

Luminaire: Ledil Oy CA12536_HEIDI-M_(Luxeon-A) Efficiency=88%
Lamps: 1 x Luxeon A 64lm@250mA CCT=2933K P=0.7W I=250mA

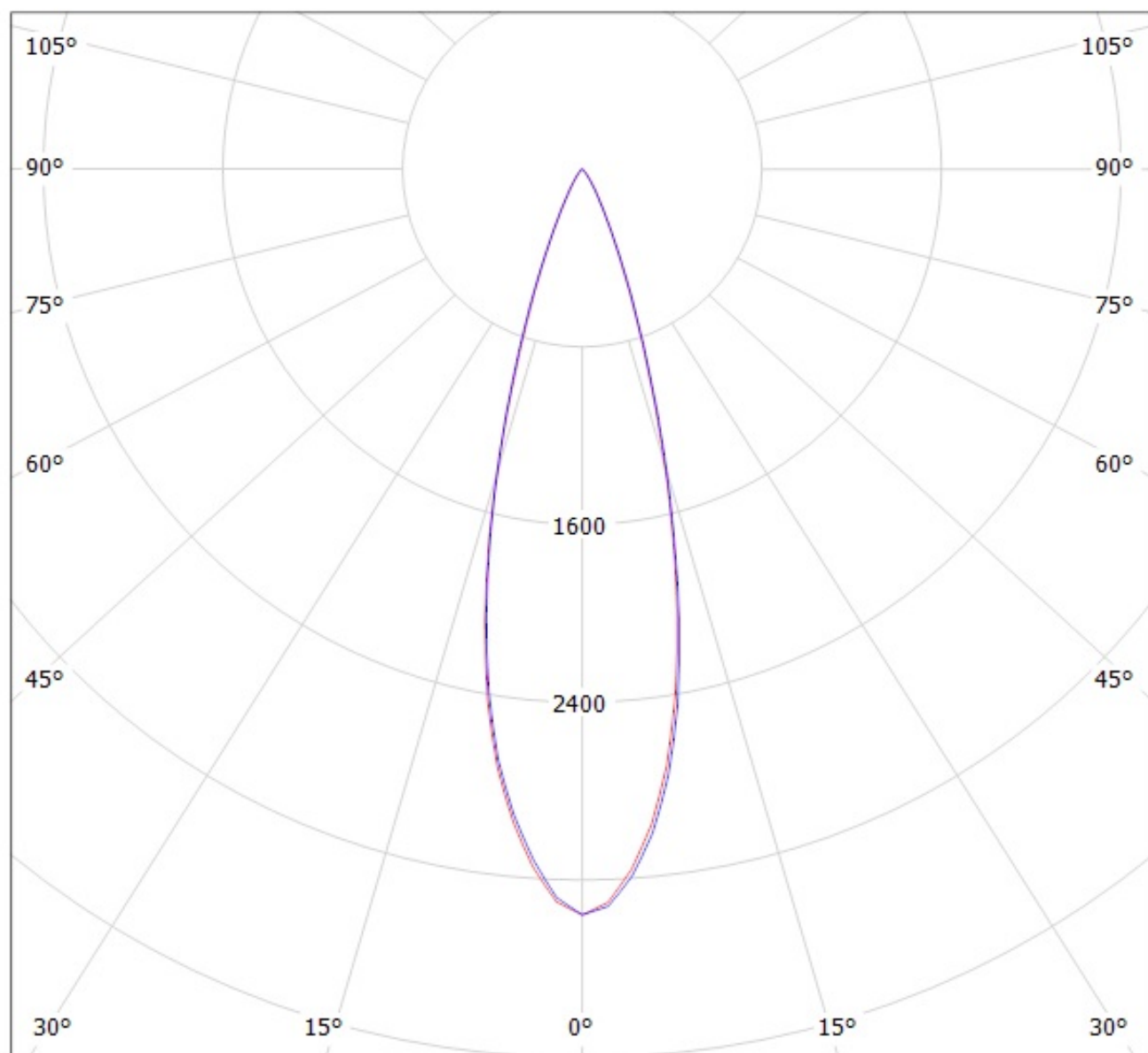

cd/klm

— C0 - C180

— C90 - C270

Luminaire: Ledil Oy CA12536_HEIDI-M_(Luxeon-R) Efficiency=87%
Lamps: 1 x Luxeon R 85lm@250mA CCT=4328K P=0.7W I=250mA

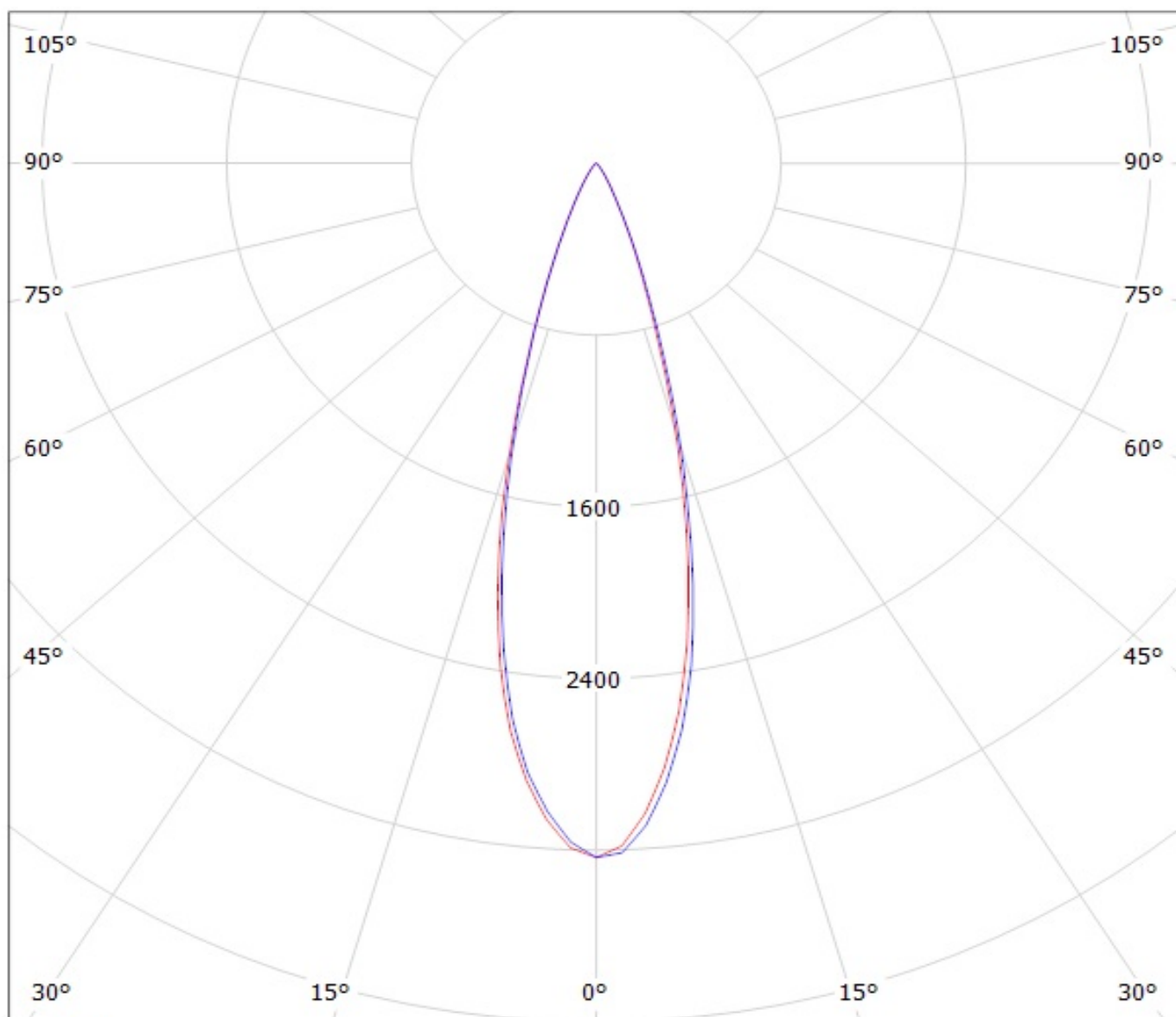

cd/klm

— C0 - C180

— C90 - C270

Luminaire: LEDiL Oy CA12536_HEIDI-M_(Luxeon_Rebel)

Lamps: 1 x Luxeon_Rebel_(LXM8-PW30)_61.9761lm@250mA_P=0.729_I=250mA

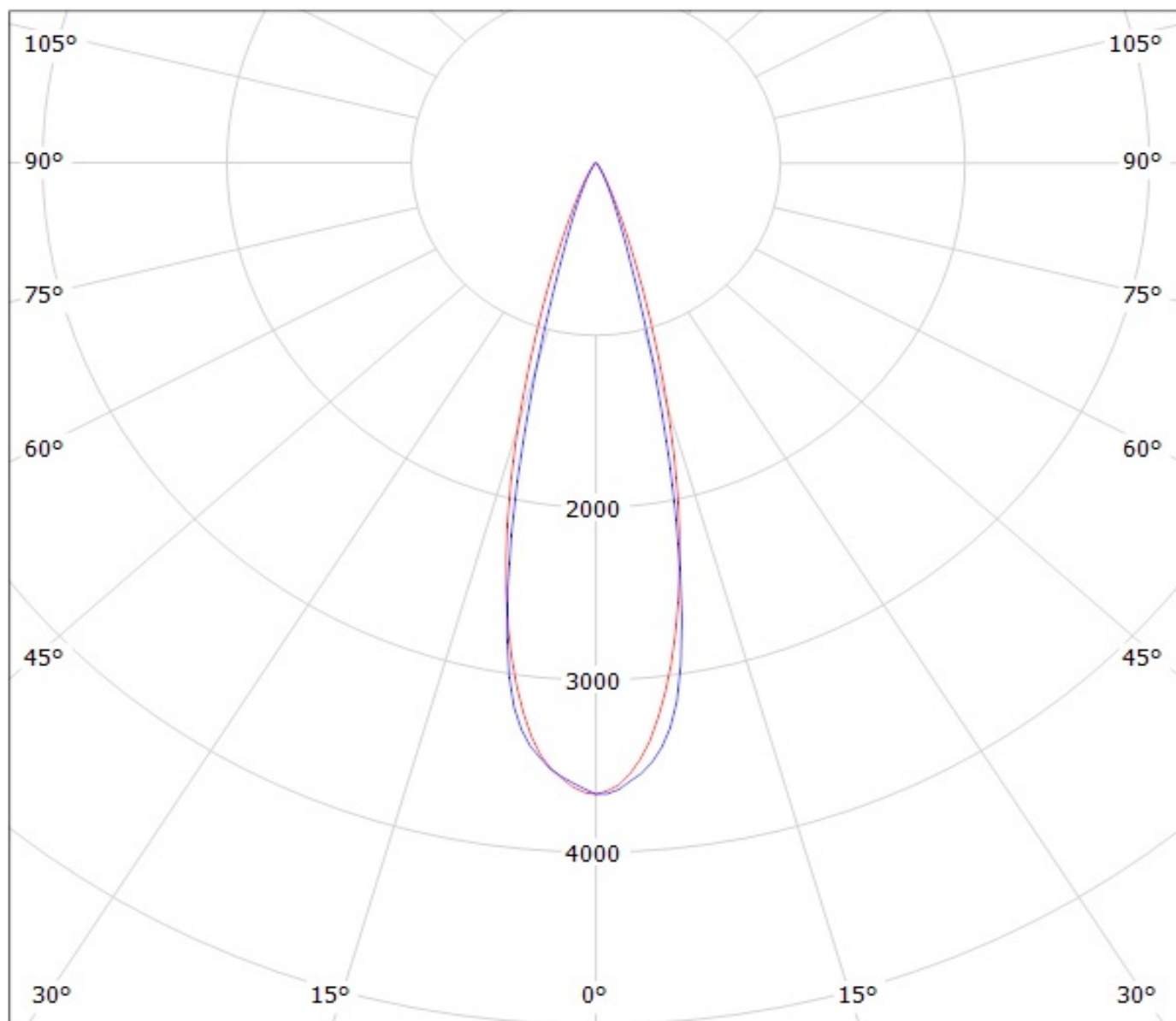

cd/klm

— C0 - C180

— C90 - C270

$\eta = 88\%$

Luminaire: LEDiL Oy CA12536_HEIDI_M_(NWSL229AE)

Lamps: 1 x Nichia_NWSL229AE_120.537lm@250mA_P=0.7126W_I=0.250A

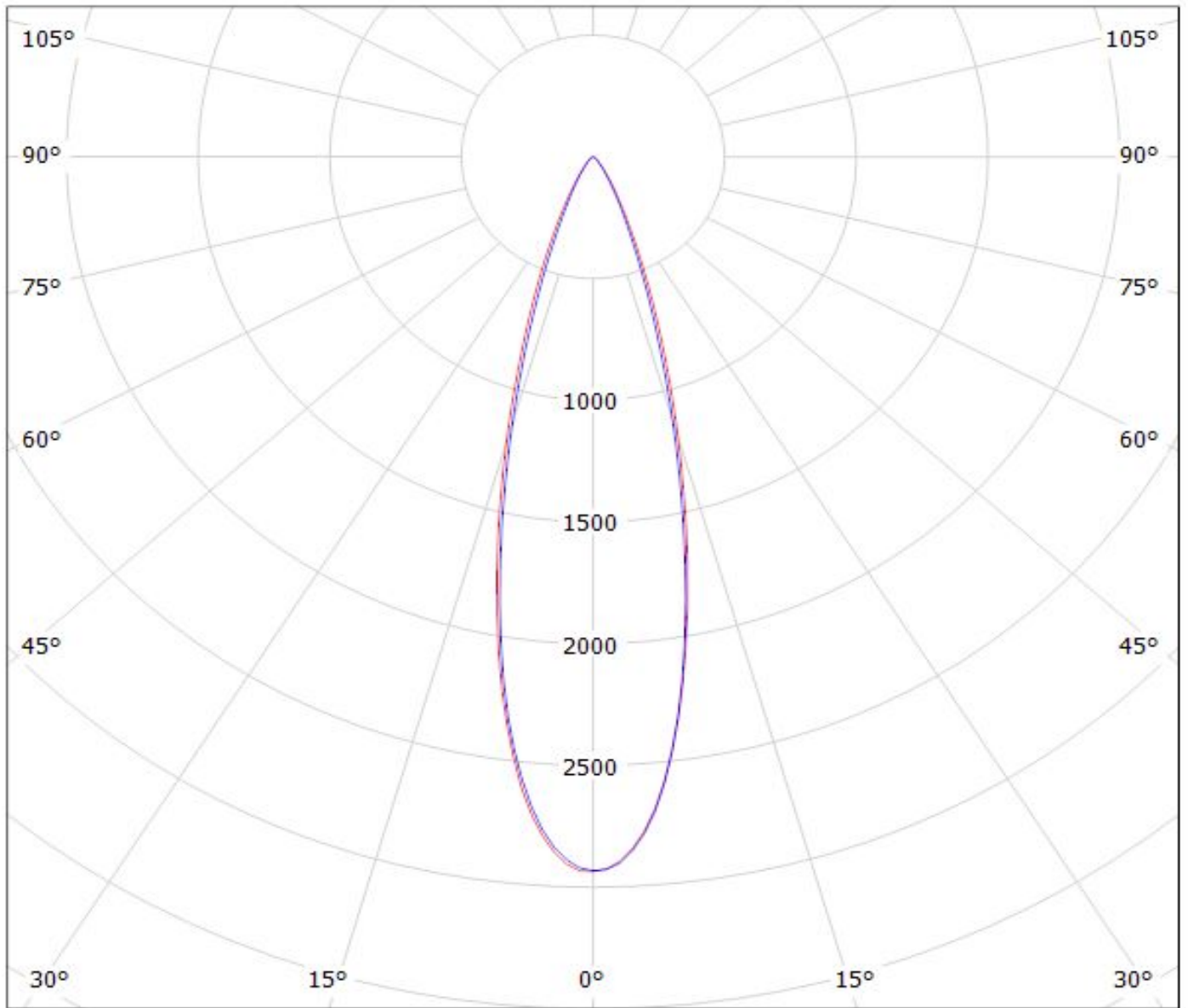

cd/klm

— C0 - C180

— C90 - C270

$\eta = 85\%$

Luminaire: Ledil CA12536_HEIDI-M_(NVSW319AE)

Lamps: 1 x Nichia_NVSW319AE_(sm405D440f2L2R70)_126.795lm@250mA_P=0.73515W_I=0.250A

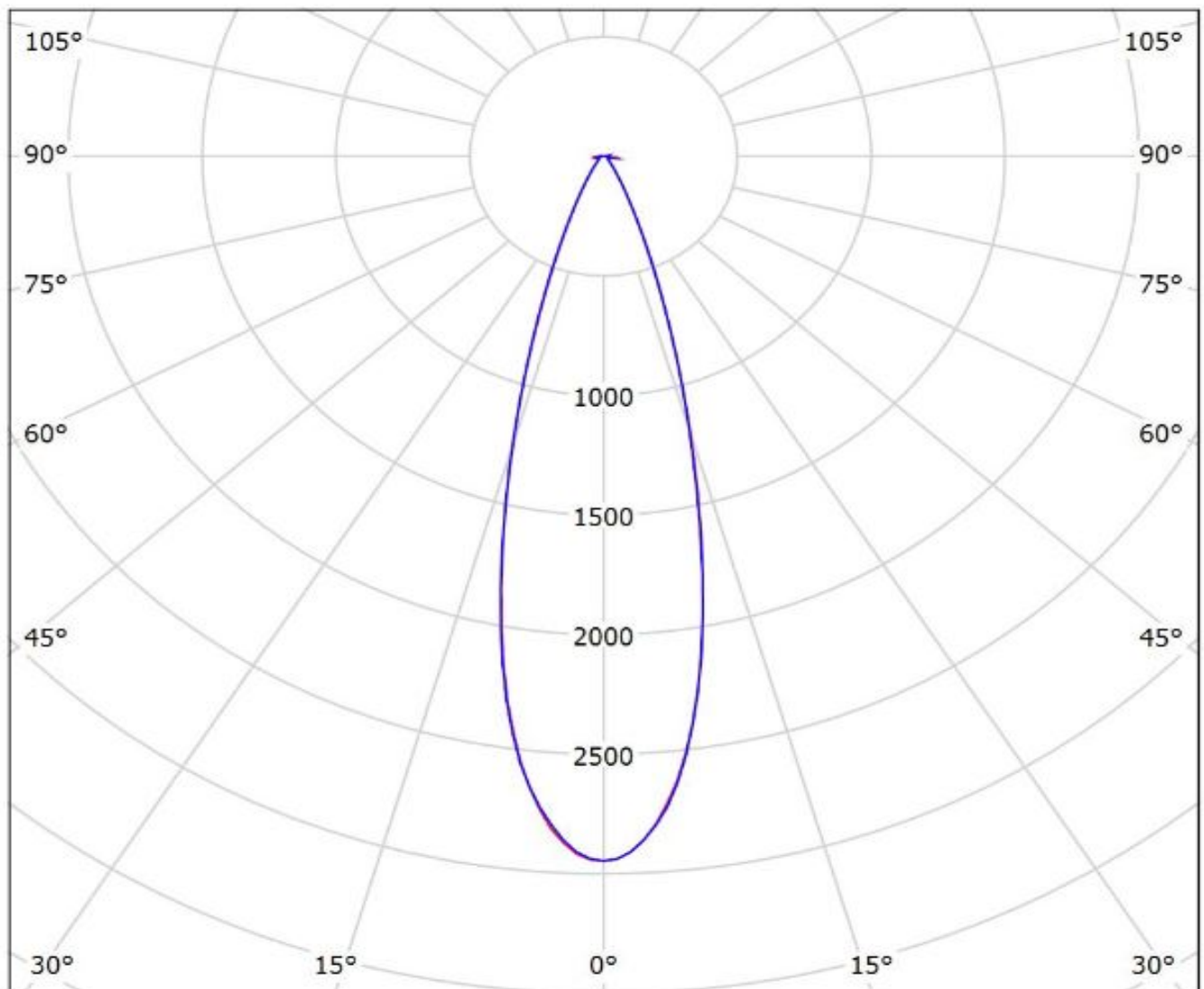

cd/klm

— C0 - C180

— C90 - C270

$\eta = 91\%$

Luminaire: LEDiL Oy CA12536_HEIDI-M_(Oslon_SSL_150)
Lamps: 1 x Osram_Oslon_SSL_150_(LCW_CRUP.EC-KTLP-607Q-1)
_77.1485lm@250mA_P=0.744_I=250mA

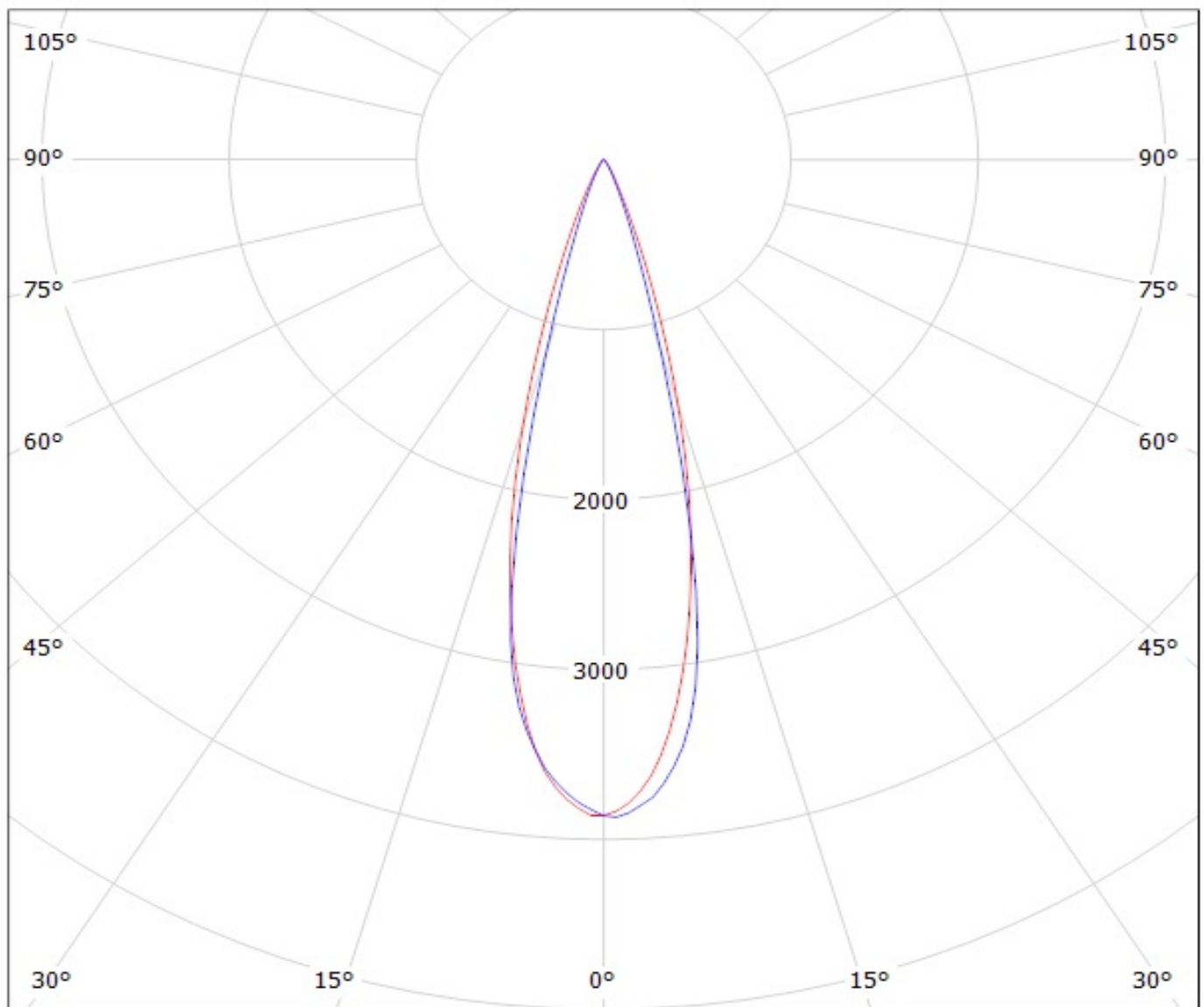

cd/klm

— C0 - C180 — C90 - C270

$\eta = 88\%$

Luminaire: Ledil Oy CA12536_HEIDI-M_(Oslon_Black_Flat)_SIMULATED
Lamps: 1 x Osram Oslon Black Flat (LUV HWQP)

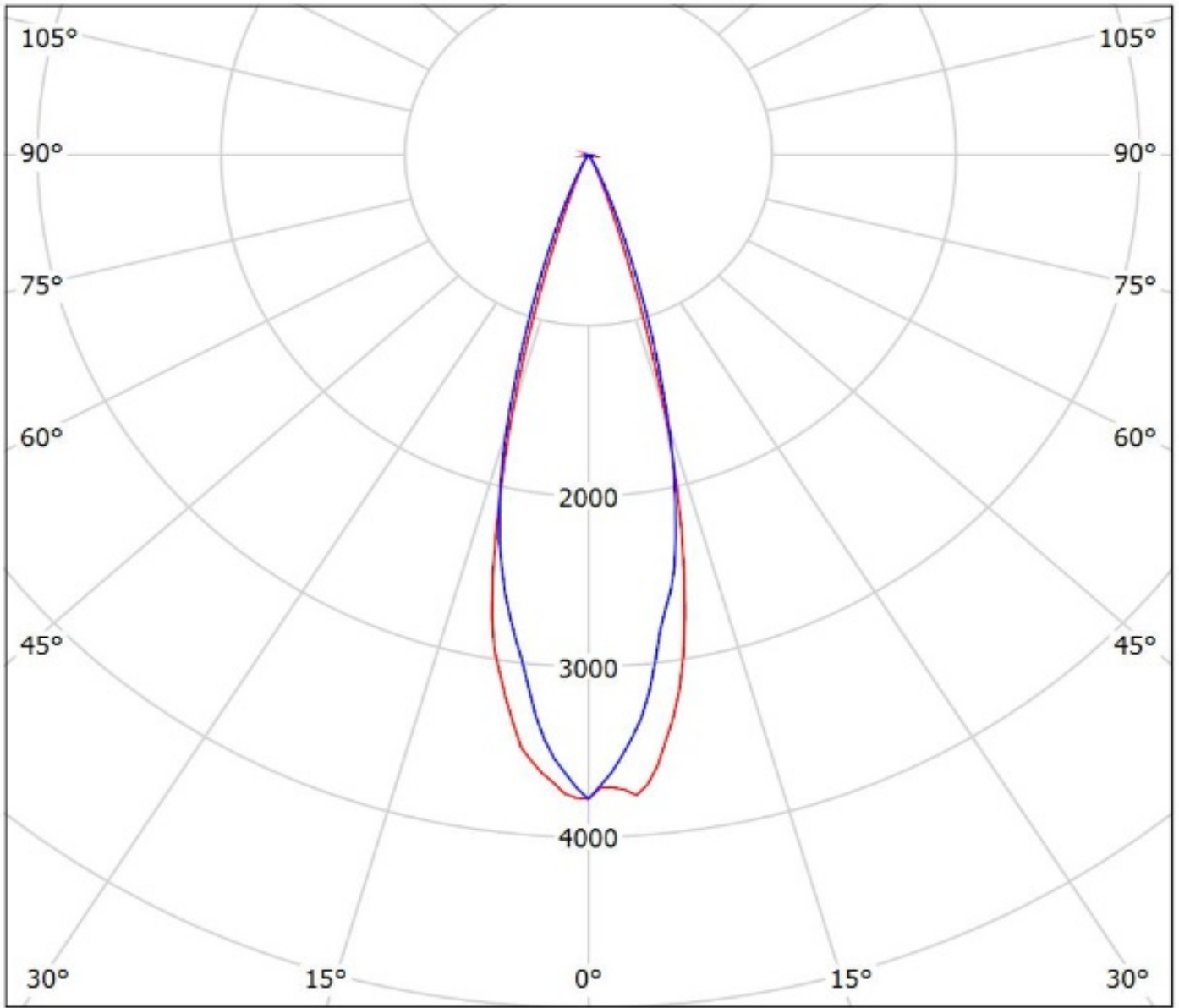

cd/klm

— C0 - C180 — C90 - C270

$\eta = 94\%$

Luminaire: LEDiL Oy CA12536_HEIDI-M_(Z8Y22plus)

Lamps: 1 x Seoul_Z8Y22plus_(W6E2G)_125.652lm@250mA_P=0.69312W_I=0.250A

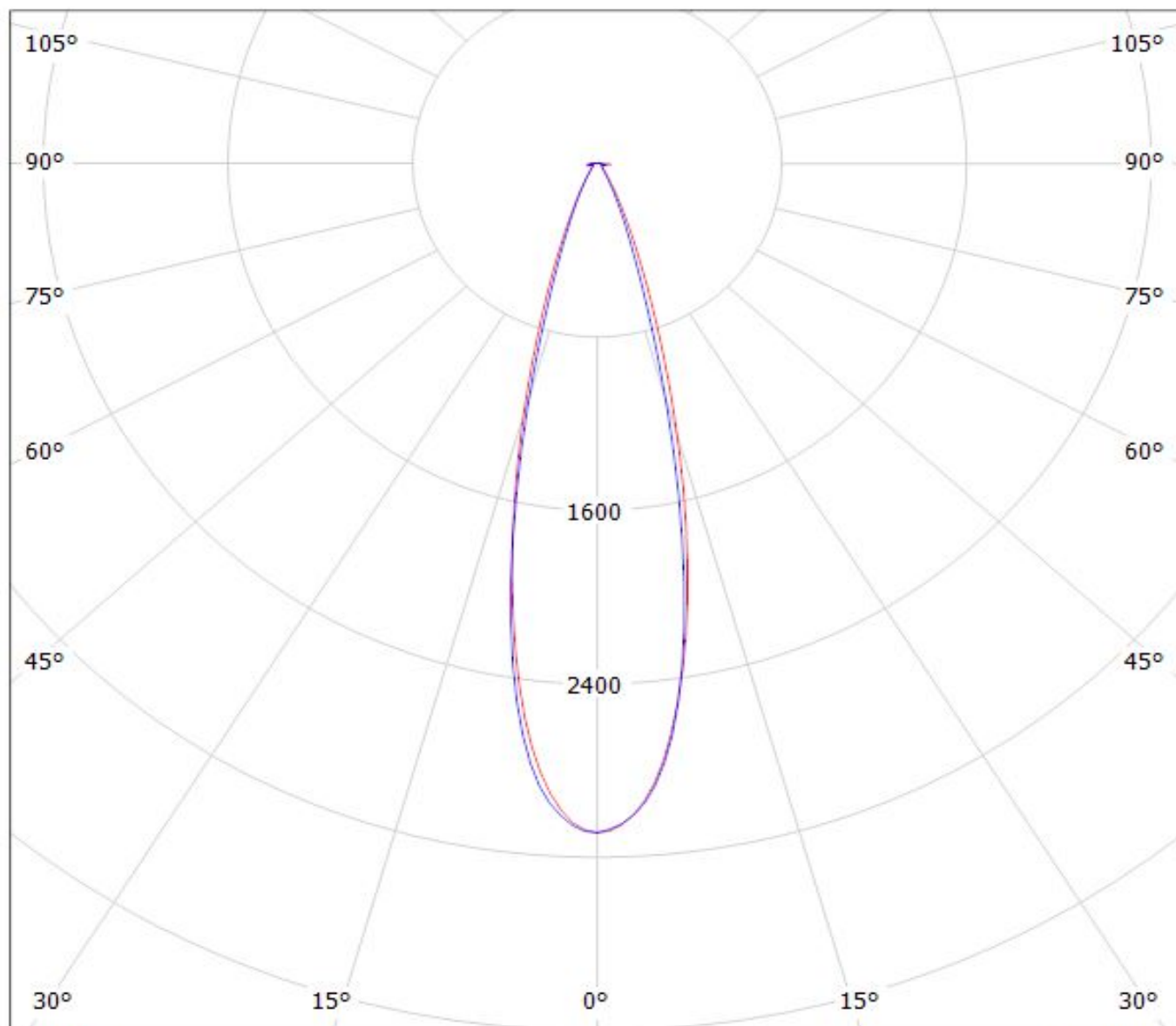

cd/klm

— C0 - C180 — C90 - C270

$\eta = 93\%$

NOTE: The typical divergence will be changed by different color, chip size and chip position tolerance. The typical total divergence is the full angle measured where the luminous intensity is half of the peak value.