

## DETAILS

<b>Product Number</b>	F14532_ANGELETTE-S
<b>Family</b>	Angelette
<b>Type</b>	Reflector
<b>Color</b>	metal
<b>Diameter</b>	110 mm
<b>Height</b>	57,3 mm
<b>Style</b>	round
<b>Optic Material</b>	PC
<b>Holder Material</b>	
<b>Fastening</b>	
<b>Status</b>	production ready
<b>ROHS Compliant</b>	Yes
<b>Date Updated</b>	8/02/2017



## OPTICAL PROPERTIES

LED	Viewing Angle	Light Beam	Efficiency	cd/lm	Connector
V22 Gen6	19 deg	Asymmetric	90 %	3.500	IDEAL: 50-2204-CT + 50-2100AN
V13 Gen7	12 deg	Asymmetric	91 %	7.000	TE: 2213254-2 + OPTIC CLIP Z50 TYPE1 2213194-1
V22 Gen7	sim: 14	Asymmetric	sim: 94 %	sim: 5.753	IDEAL: 50-2204-CT + 50-2100AN
V13 Gen7	sim: 12	Asymmetric	8 %	sim: 7.980	IDEAL: 50-2103CT + 50-2100AN
CLL03x/CLU03x	13 deg	Asymmetric	90 %	6.200	TE: 2213254-2 + OPTIC CLIP Z50 TYPE1 2213194-1
CLL04x/CLU04x	19 deg	Asymmetric	90 %	3.400	IDEAL: 50-2204-CT + 50-2100AN
CLU730/731	12 deg	Asymmetric	89 %	6.600	IDEAL: 50-2204-CT + 50-2100AN
CLL03x/CLU03x	13 deg	Asymmetric	89 %	6.000	IDEAL: 50-2103CT + 50-2100AN
LUXEON CoB 1208	13 deg	Asymmetric	89 %	6.200	TE: 2213130-2 + OPTIC CLIP Z50 TYPE1 2213194-1
LUXEON CoB 1208	13 deg	Asymmetric	89 %	5.600	IDEAL: 50-2100SH + 50-2100AN
LUXEON CoB 1211	17 deg	Asymmetric	89 %	4.200	IDEAL: 50-2204-CT + 50-2100AN
LUXEON CoB 1216	20 deg	Asymmetric	89 %	3.300	IDEAL: 50-2204-CT + 50-2100AN
COB L-Type (LES 11)	10 deg	Asymmetric	89 %	8.200	IDEAL: 50-2100NC + 50-2100AN
COB L-Type (LES 11)	10 deg	Asymmetric	90 %	9.500	TE: 2213382-2 + OPTIC CLIP Z50 TYPE1 2213194-1
COB J-Type	13 deg	Asymmetric	91 %	5.600	IDEAL: 50-2103NC + 50-2100AN
PrevaLED Core Z4 LES19	14 deg	Asymmetric	90 %	5.400	TE: OPTIC CLIP Z50 TYPE1 2213194-1
Soleriq S19	14 deg	Asymmetric	90 %	5.300	TE: 2213407-2 + OPTIC CLIP Z50 TYPE1 2213194-1
Soleriq S13 Gen2	11 deg	Asymmetric	89 %	7.900	TE: 2213254-2 + OPTIC CLIP Z50 TYPE1 2213194-1
Soleriq S13 Gen2	12 deg	Asymmetric	89 %	7.000	IDEAL: 50-2103CT + 50-2100AN
Soleriq S13 Gen2	12 deg	Asymmetric	89 %	7.000	IDEAL: 50-2103CT + 50-2100AN
Fortimo SLM G5 LES 15 Standard	13 deg	Asymmetric	89 %	6.000	TE: OPTIC CLIP Z50 TYPE1 2213194-1
LC040C	10 deg	Asymmetric	90 %	8.800	TE: 2213382-2 + OPTIC CLIP Z50 TYPE1 2213194-1
MJT COB LES 14.5	14 deg	Asymmetric	89 %	5.700	TE: 2213254-2 + OPTIC CLIP Z50 TYPE1 2213194-1
SLE G6 LES15	sim: 11	Asymmetric	sim: 90 %	sim: 10.800	TE: 2213254-2 + OPTIC CLIP Z50 TYPE1 2213194-1
SLE G6 LES17	sim: 13	Asymmetric	8 %	sim: 0.000	TE: 2213254-2 + OPTIC CLIP Z50 TYPE1 2213194-1



**PRODUCT DATASHEET**  
**Angelette series**  
last update 8/2/2017

## OPTICAL PROPERTIES

LED	Viewing Angle	Light Beam	Effi- ciency	cd/lm	Connector
WU-M-484	12 deg	Asymmetric	89 %	7.100	TE: OPTIC CLIP Z50 TYPE1 2213194-1

NOTE:  
 Customer may add additional light modifying parts to Angelette family(excluding the plain versions):  
 Minumum height of additional part is 1.5mm and maximum is 2.2mm. Diameter is 105.9mm±0.3

57.26 + Basepart

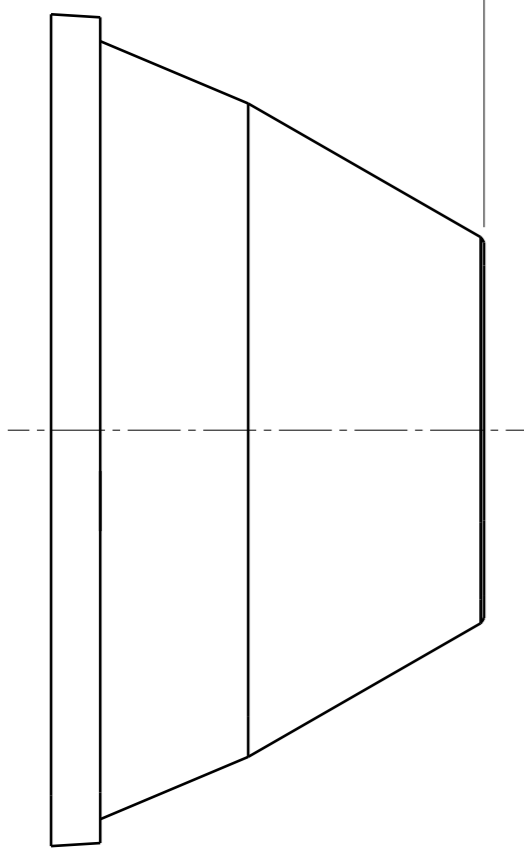

Front view

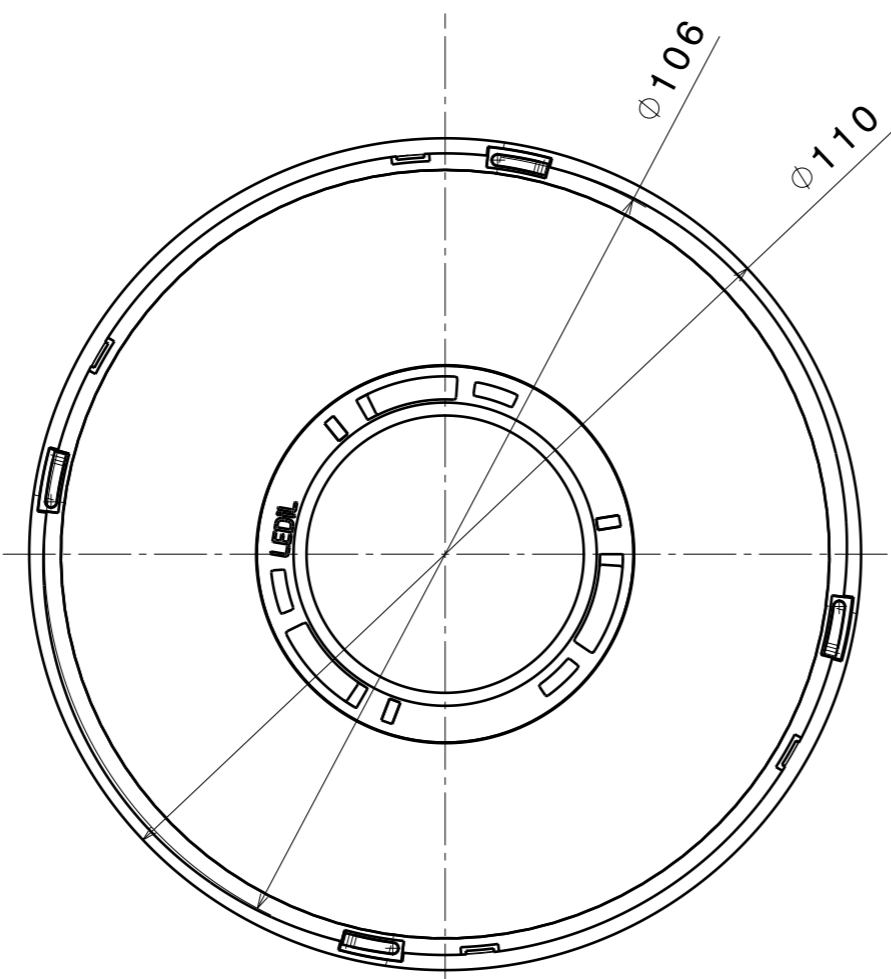

Top view



Additional part

2.5

Section view A-A

ANGELETTE-S

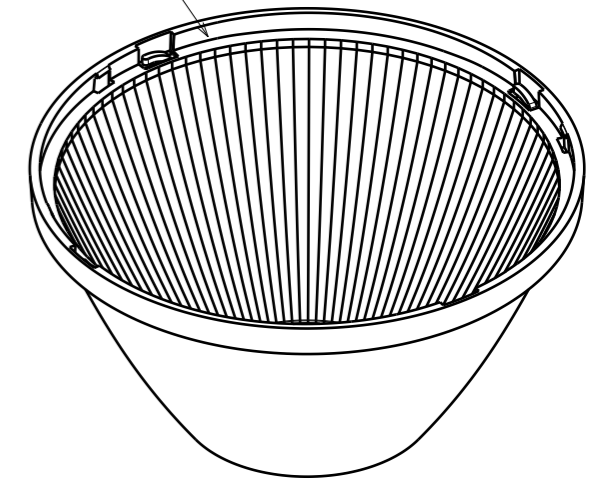

ANGELETTE-S-PLAIN

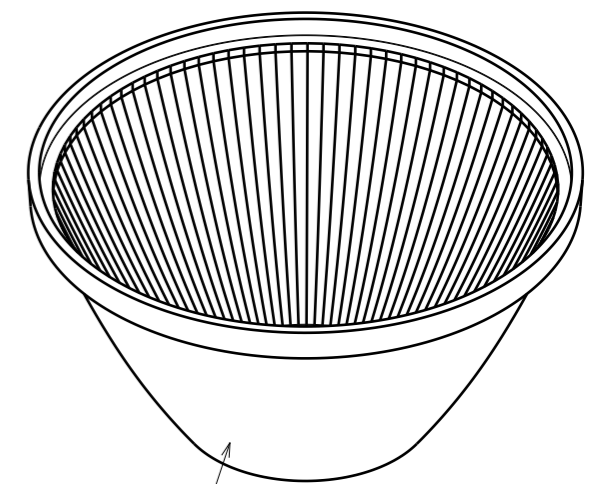

Tolerances if not otherwise shown  
 According to DIN ISO 2768-1  
 Linear measures:  
 up to 30mm class M, otherwise class C  
 According to DIN ISO 2768-2  
 Form and position: class L

**LEDiL** Ledil Oy  
 Salorankatu 10  
 FIN 24240 SALO  
 Finland

THIRD ANGLE PROJECTION:

DRAWING TITLE  
**Datasheet\_ANGELETTE-S**

This drawing is the property  
 of LEDiL Oy. It may not be  
 reproduced, copied or  
 communicated without a written  
 agreement with LEDiL Oy.

SIZE **A3** PART NUMBER **ANGELETTE-S**  
**ANGELETTE-S-PLAIN**

SCALE **1:1** WEIGHT SHEET **1/1**

Luminaire: Ledil F14532\_ ANGELETTE-S\_(V22+IDEAL)  
Lamps: 1 x Bridgelux\_V22\_(BXRE30E6500H-Y2)\_+50-2204CT+\_50-2100AN\_1193.54lm@250mA\_CCT=3000K\_P=8.0988W\_I=0.25A

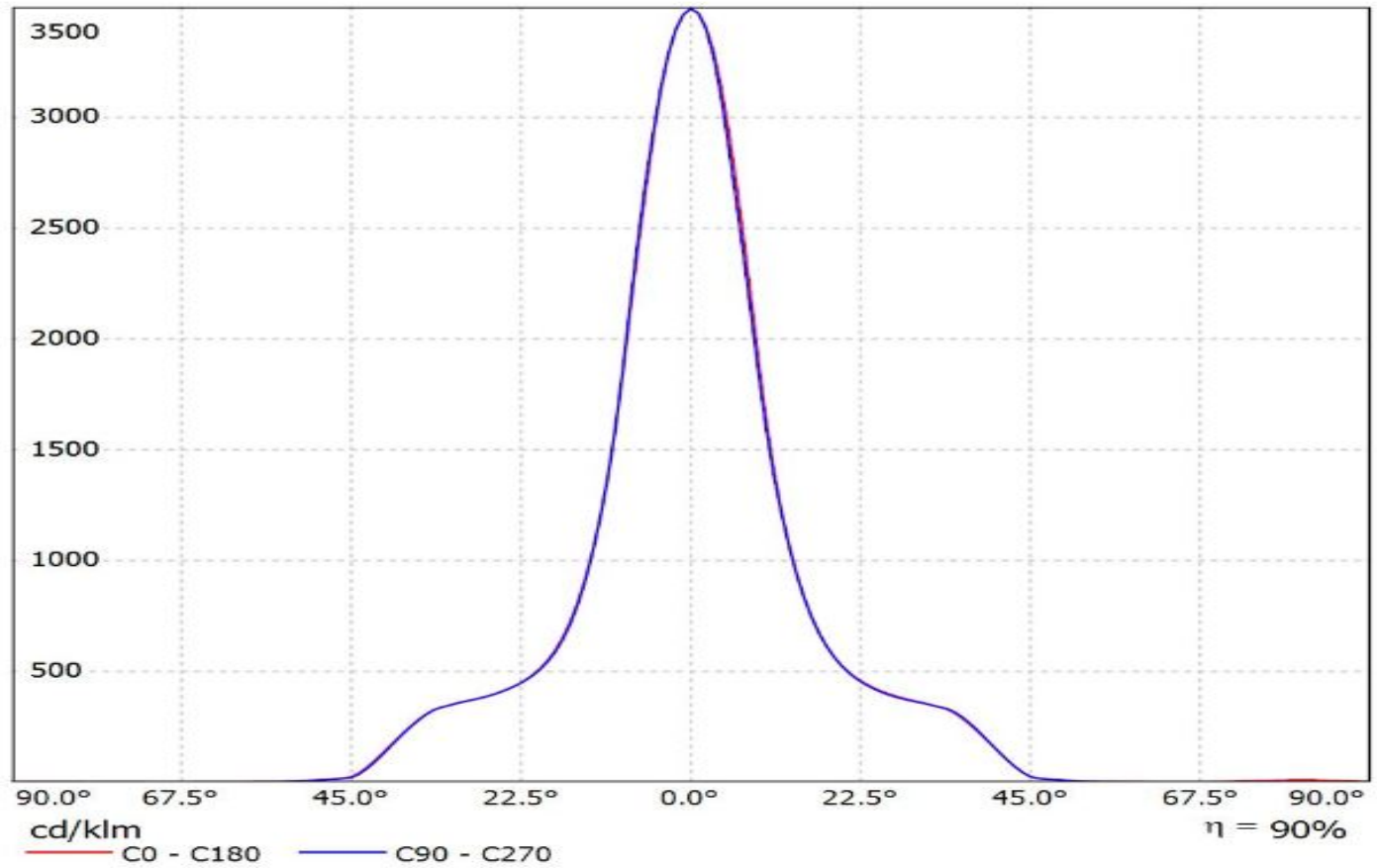

Luminaire: LEDiL Oy F14532\_ANGELETTE-S\_(V13\_Gen7)+TE

Lamps: 1 x Bridgelux\_V13\_Gen7\_(BXRE-30E2000-B\_+TE\_2213254-2+TE\_2213194-1)\_1295.55lm@250mA\_P=8.30985W\_I=0.25A

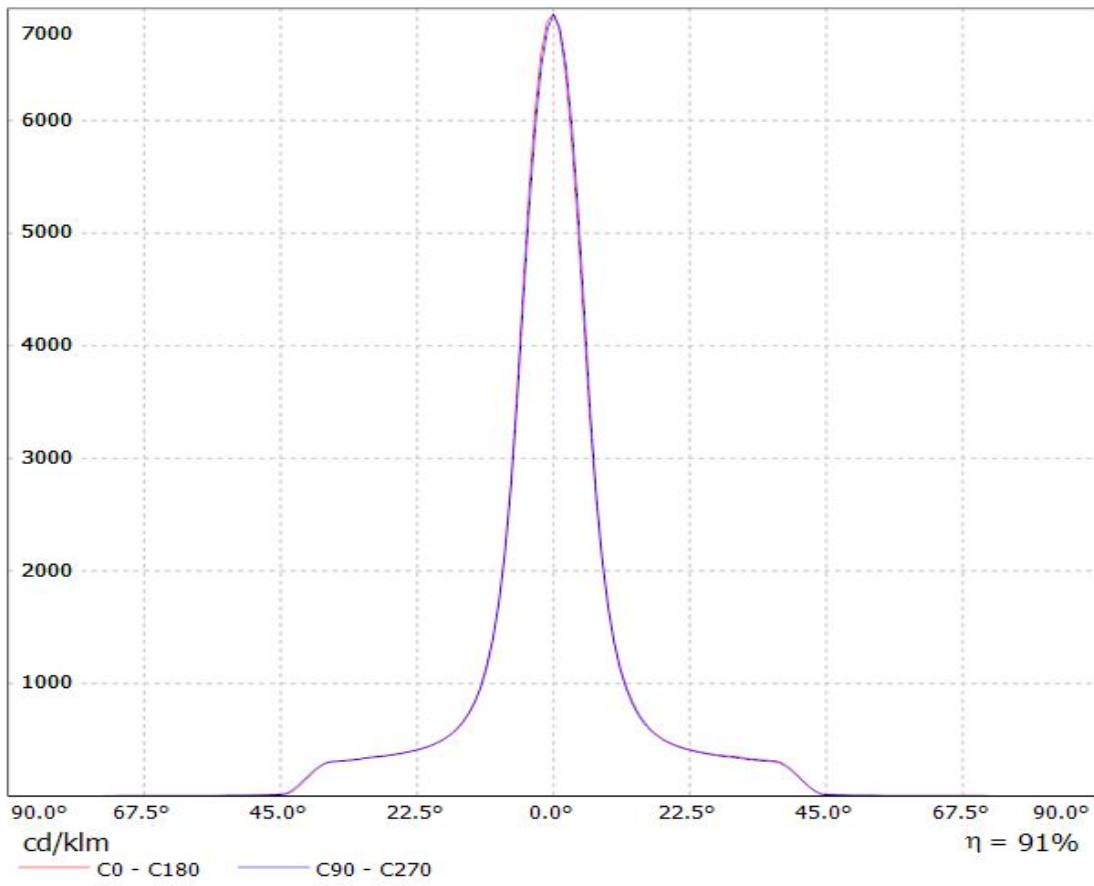

Luminaire: Ledil Oy F14532\_ANGELETTE-S\_Bridgelux\_V22\_Gen7\_SIMULATED F14532\_ANGELETTE-S\_Bridgelux\_V22\_Gen7\_SIMULATED  
Lamps: 1 x F14532\_ANGELETTE-S\_Bridgelux\_V22\_Gen7\_SIMULATED

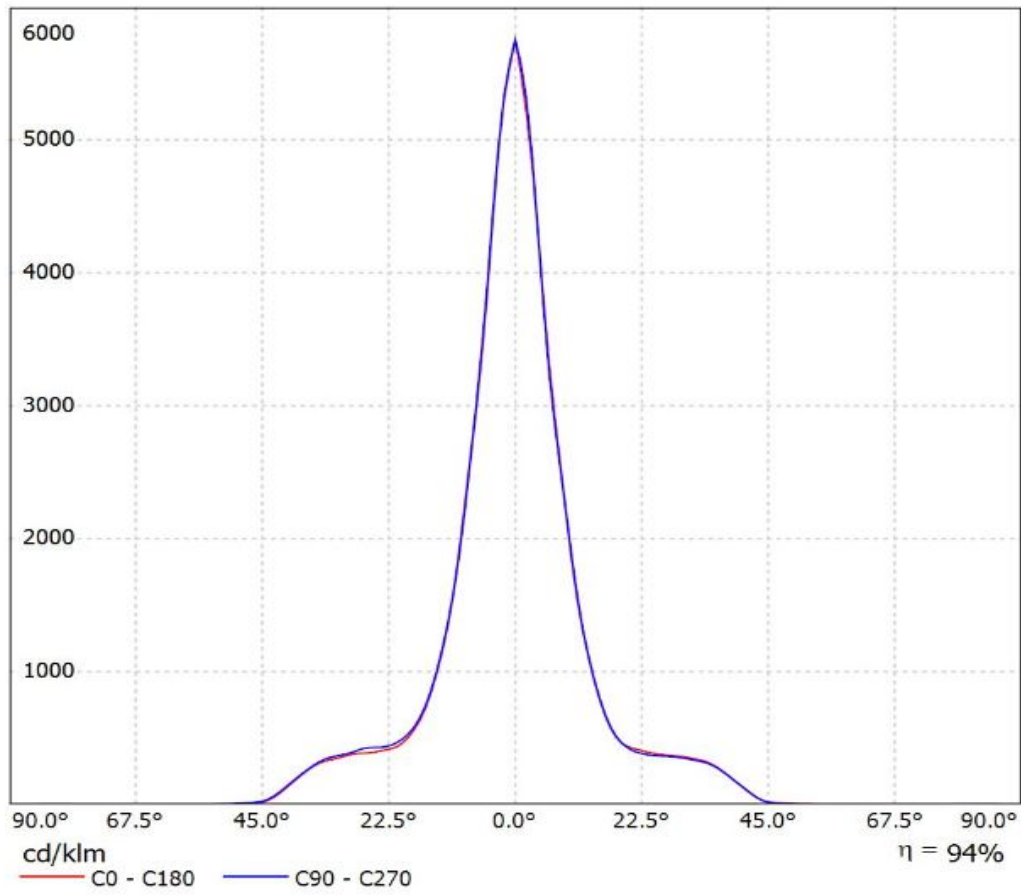

Luminaire: Ledil F14532\_ANGELETTE-S\_(CLU038+TE)  
Lamps: 1 x Citizen\_CLU038\_(-1205C4-273MZK1)\_+2213254-2\_+2213194-  
1\_1351.18lm@250mA\_P=8.4078W\_I=0.25A

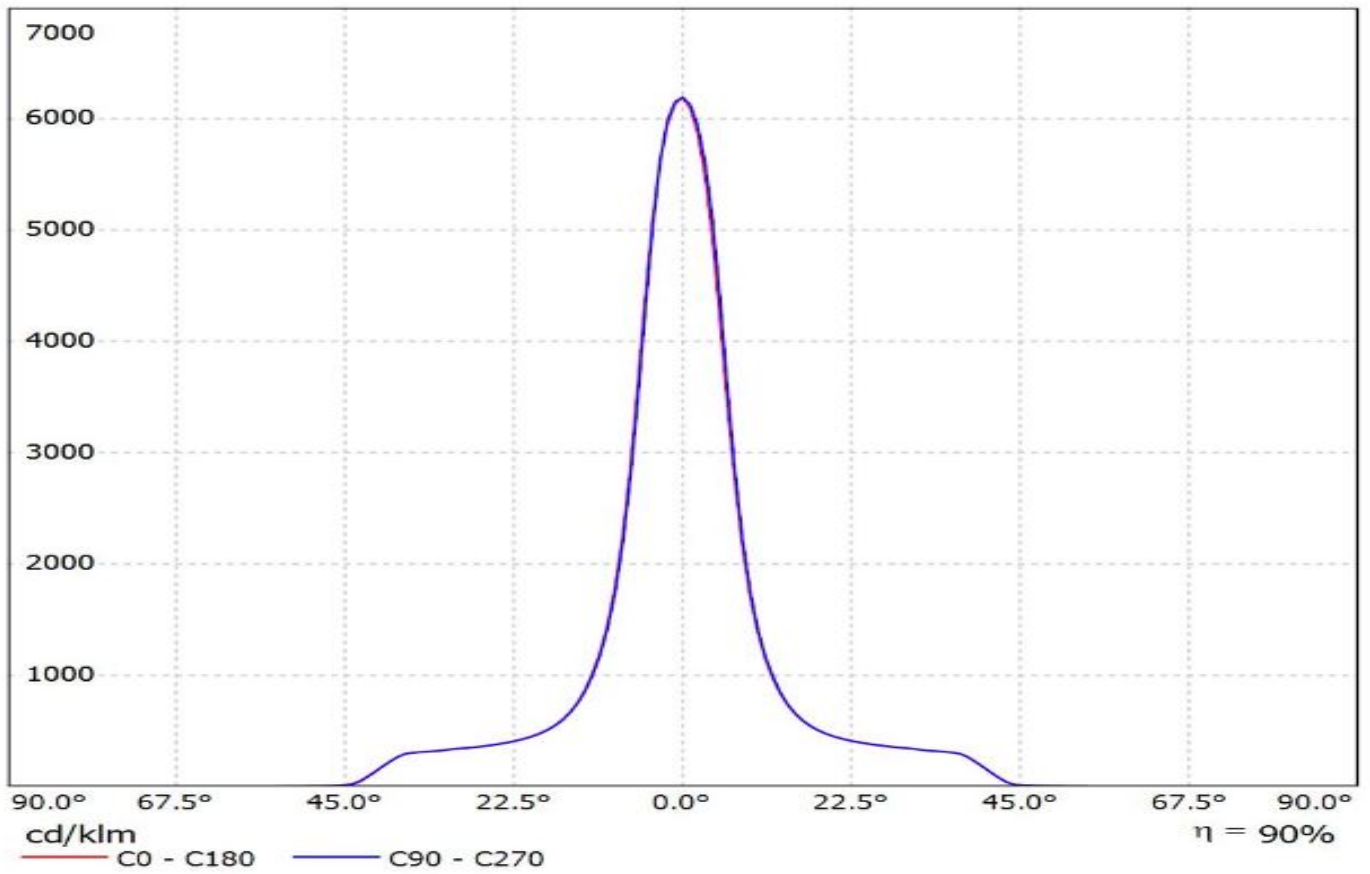

Luminaire: Ledil F14532\_ANGELETTE-S\_(CLU046+IDEAL)

Lamps: 1 x Citizen\_CLU046\_(-1212C1-303M2G2)\_1383.92lm@250mA\_CCT=3000K\_P=8.122W\_I=0.25A

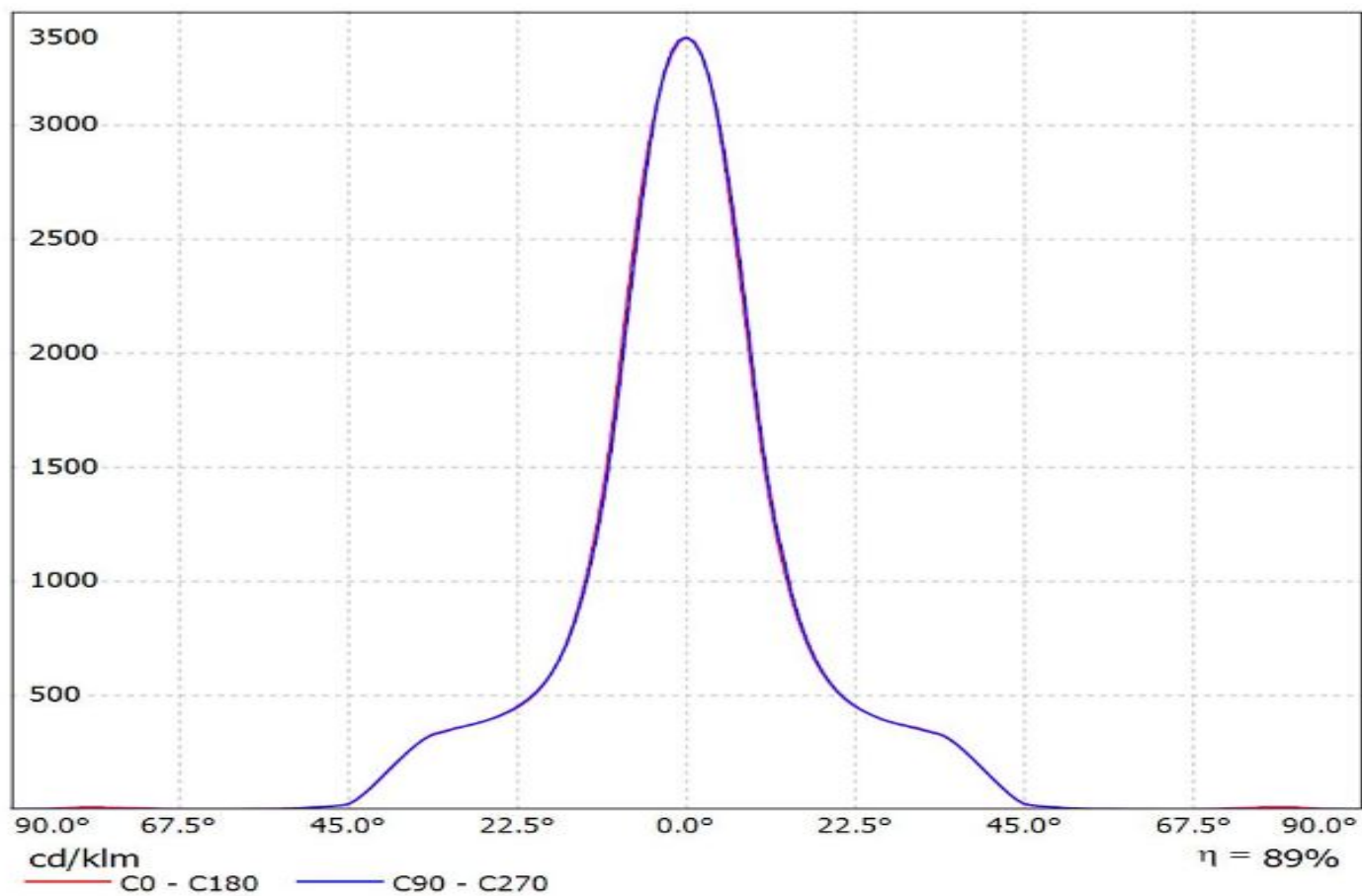



Luminaire: Ledil F14532\_ANGELETTE-S (CLU730+IDEAL)

Lamps: 1 x Citizen\_CLU730\_(-1210B8-273M2G1)\_IDEAL\_50-2204C+50-2100AN

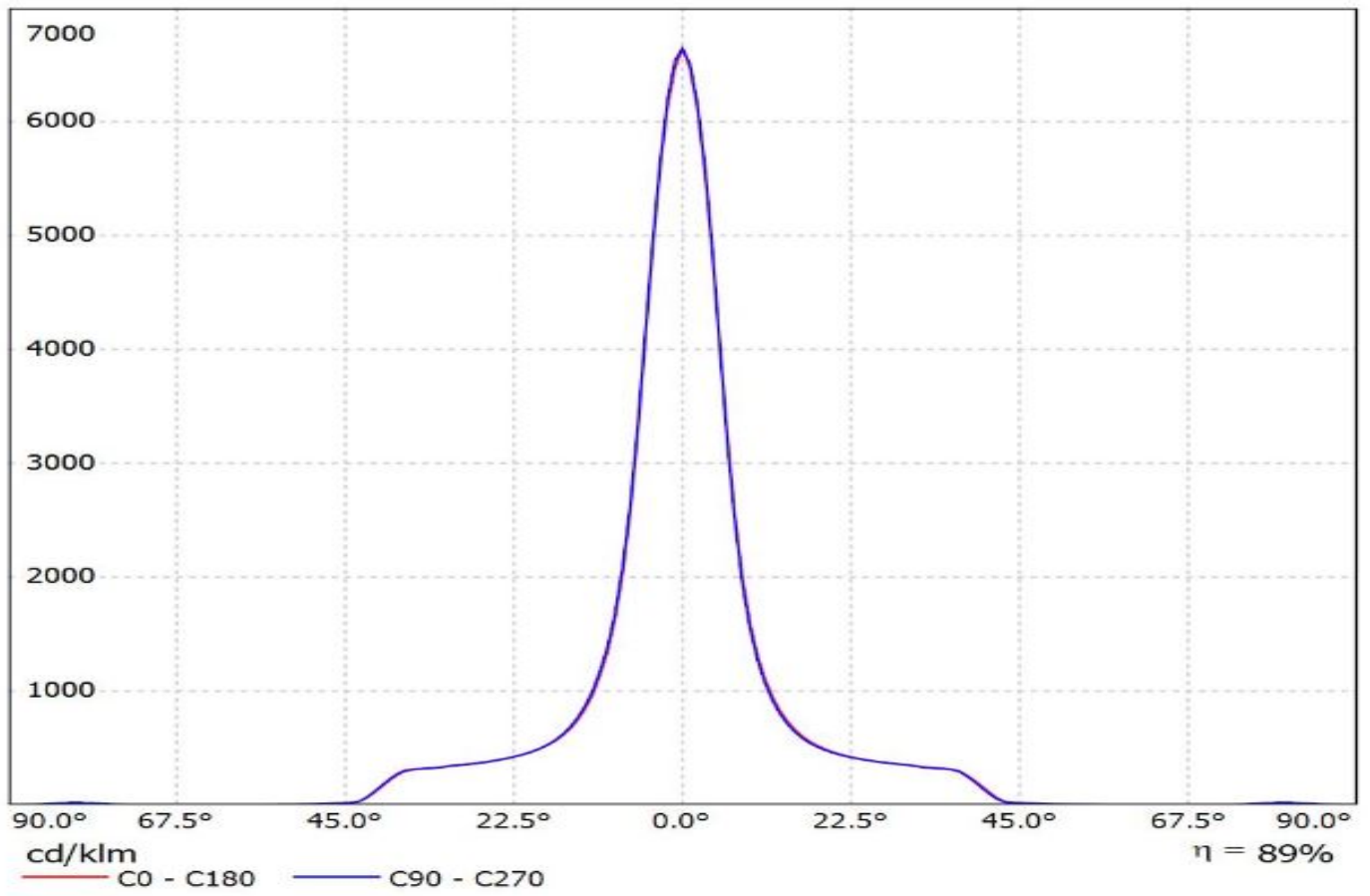

Luminaire: Ledil F14532\_ANGELETTE-S\_(CLU036+IDEAL)  
Lamps: 1 x CITIZEN\_CLU036\_(-1208C1-303M2G2)\_IDEAL\_50-2103CT+50-2100AN\_1299.86lm@250mA\_CCT=3000K\_P=8.249W\_I=0.25A

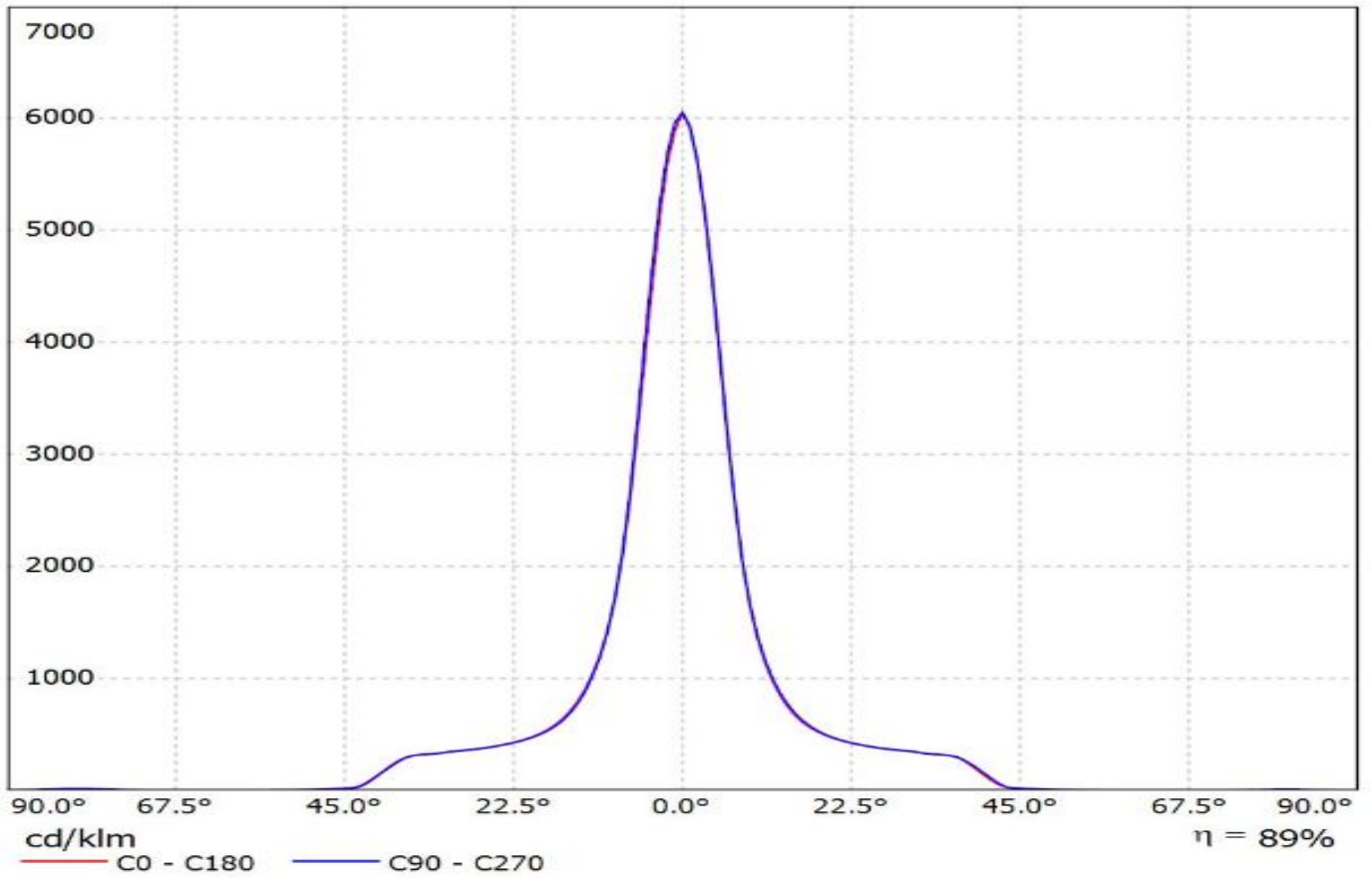

Luminaire: Ledil F14532\_ANGELETTE-S\_(CoB1208+TE)  
Lamps: 1 x Luxeon\_CoB1208\_+ 2213130-2\_+ 2213194-  
1\_1055.15lm@250mA\_CCT=3000K\_P=8.3007W\_I=0.25A

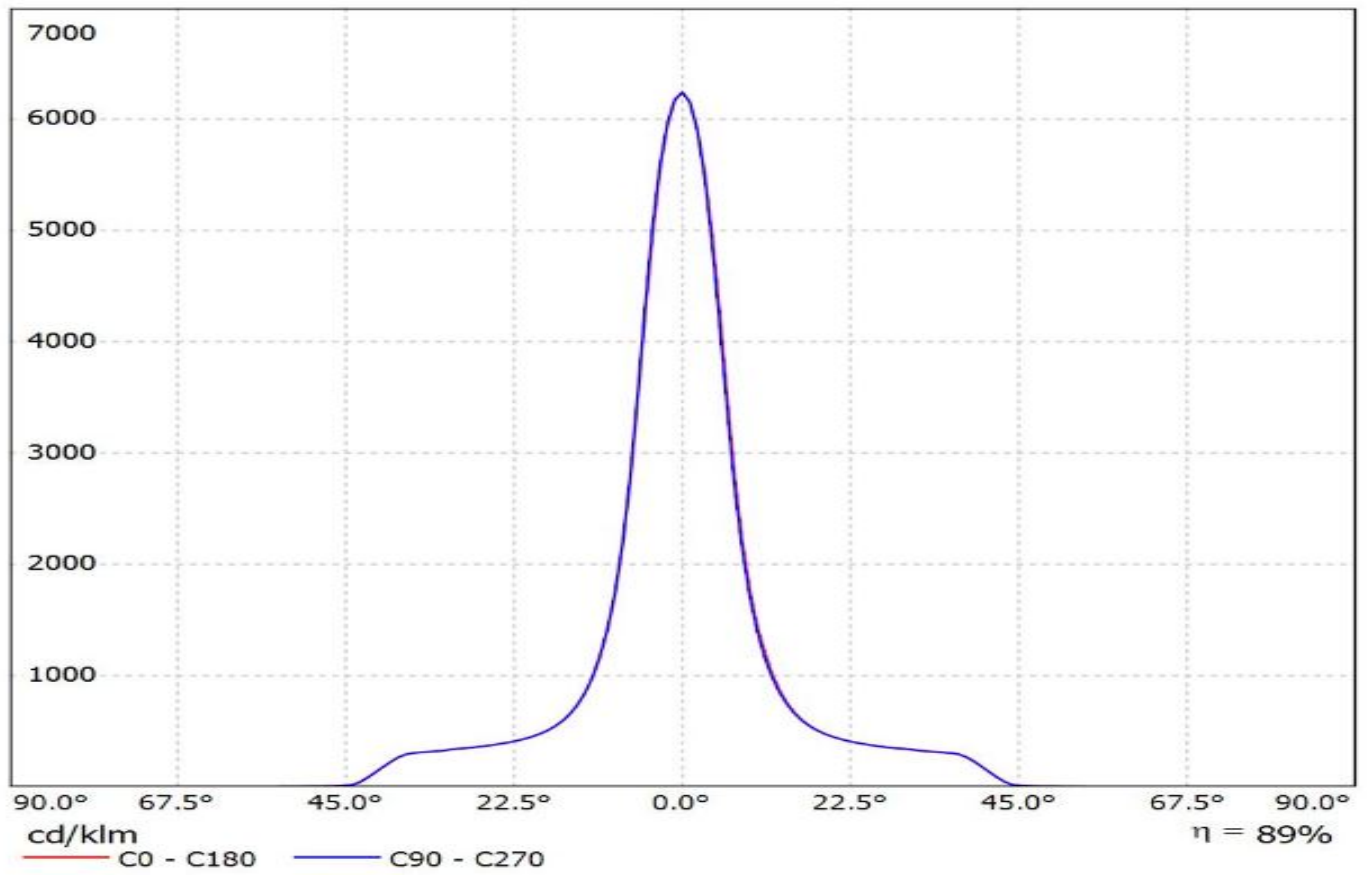

Luminaire: Ledil F14532\_ANGELETTE-S\_(CoB1208+IDEAL)  
Lamps: 1 x Luxeon\_CoB1208\_+ 50-2100SH+50-2100AN\_1062.11lm@250mA\_CCT=3000K\_P=8.3007W\_I=0.25A

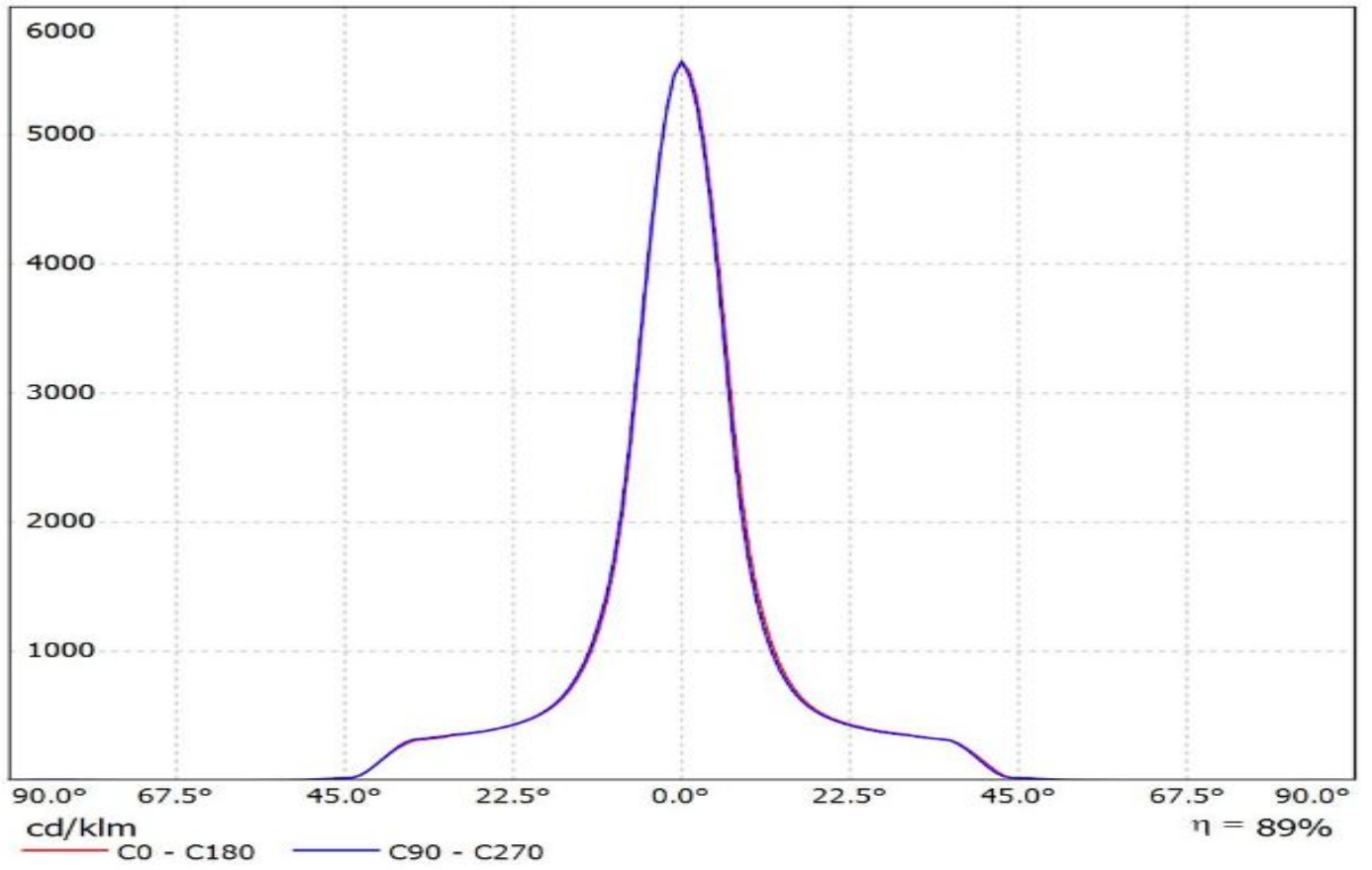

Luminaire: Ledil F14532\_ANGELETTE-S\_(CoB1211+IDEAL)  
Lamps: 1 x Luxeon\_CoB1211\_(L2C2-4080)\_50-2204CT+50-2100AN\_1376.18lm@250mA\_P=7.9988W\_I=0.25A

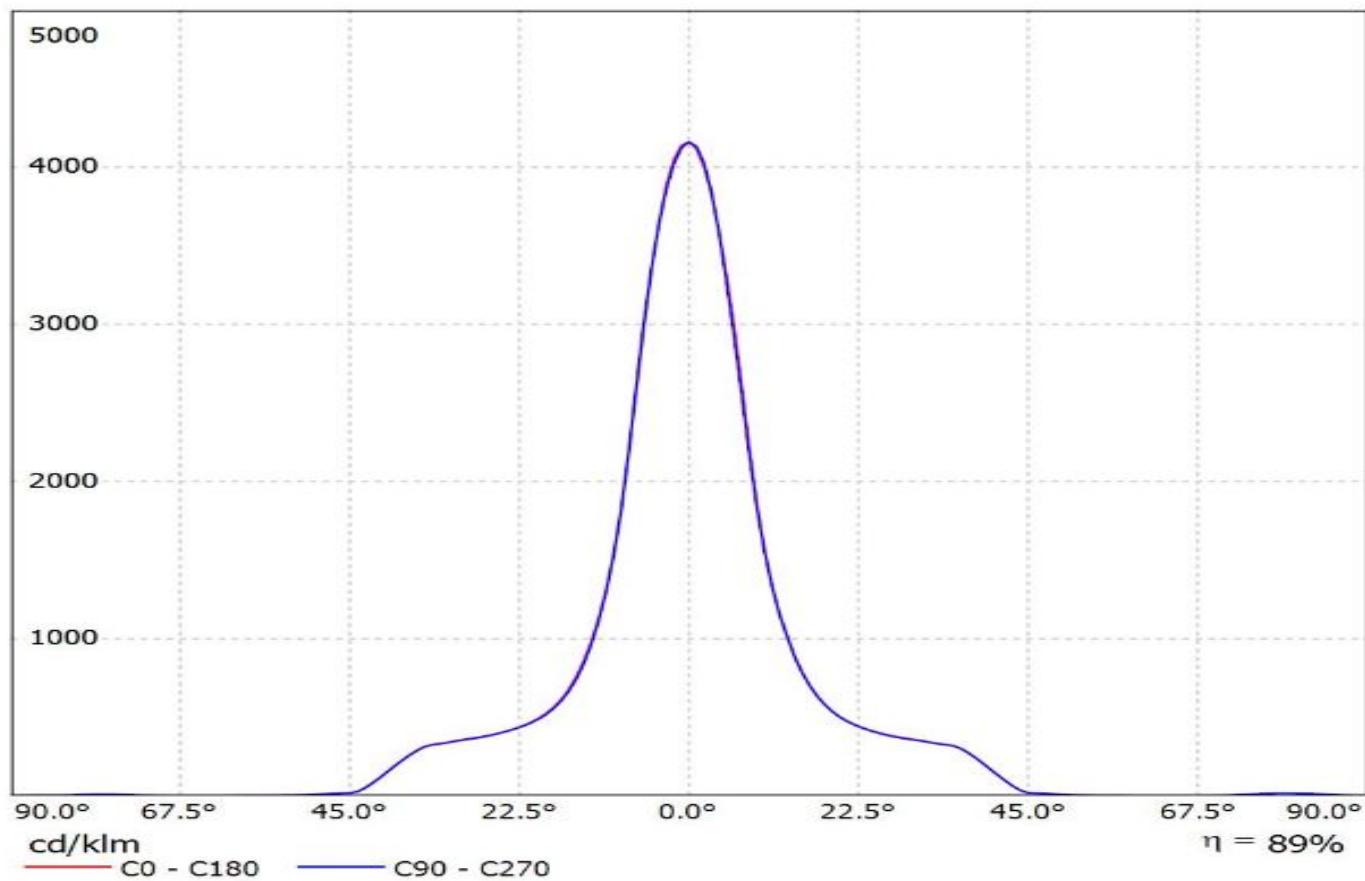

Luminaire: Ledil F14532\_ANGELETTE-S (CoB1216\_IDEAL)  
Lamps: 1 x Luxeon\_CoB1216\_(L2C2-40801216E2300)\_+50-2204C\_+\_50-2100AN\_1447.57lm@250mA\_CCT=4000K\_P=8.0135W\_I=0.25A

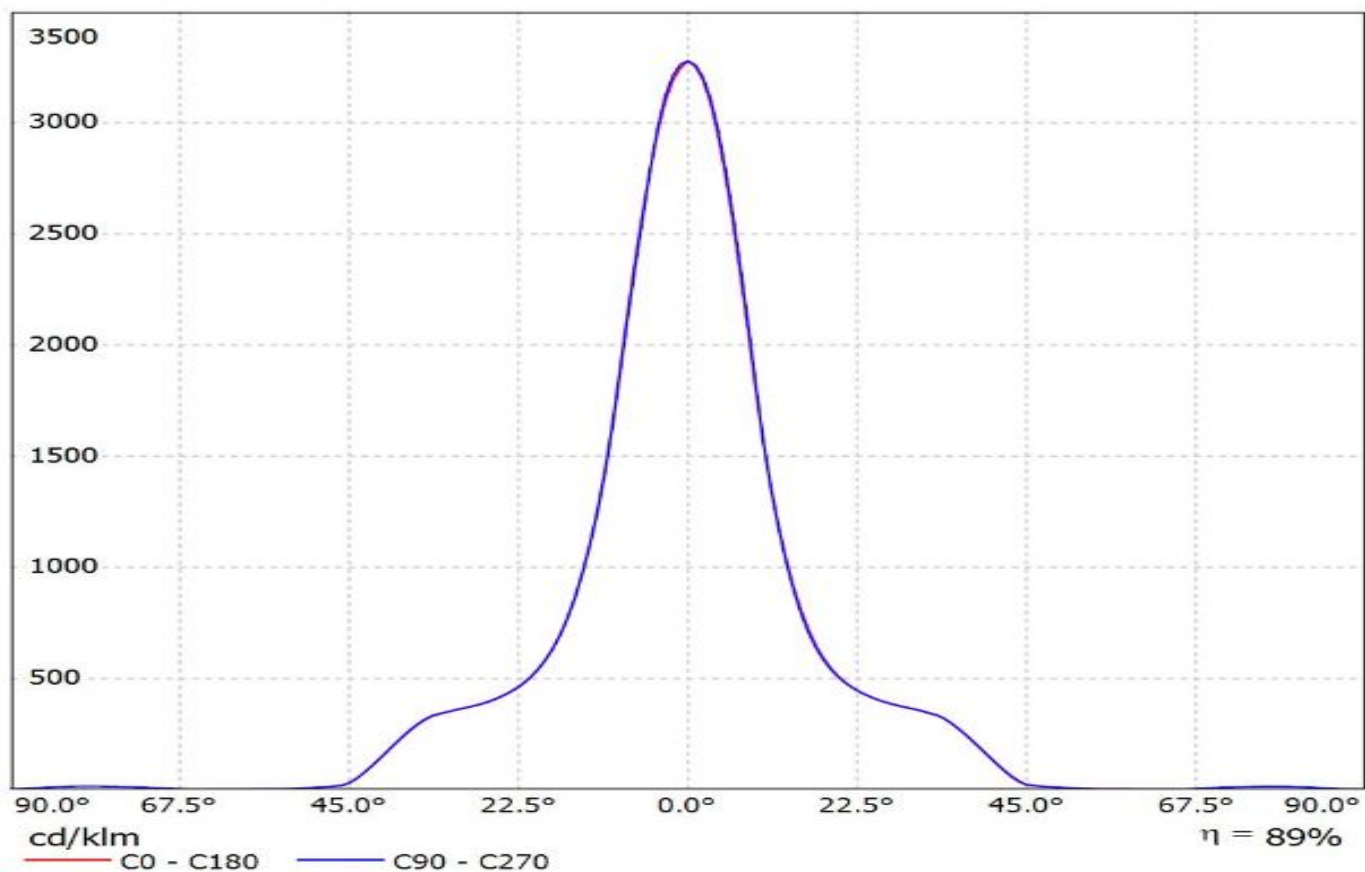

Luminaire: Ledil F14532\_ANGELETTE-S\_(NVCLL024Z+IDEAL)  
Lamps: 1 x Nichia\_NVCxL024z\_(NVCLL024z)\_975.455lm@250mA\_P=8.1468W\_I=250A

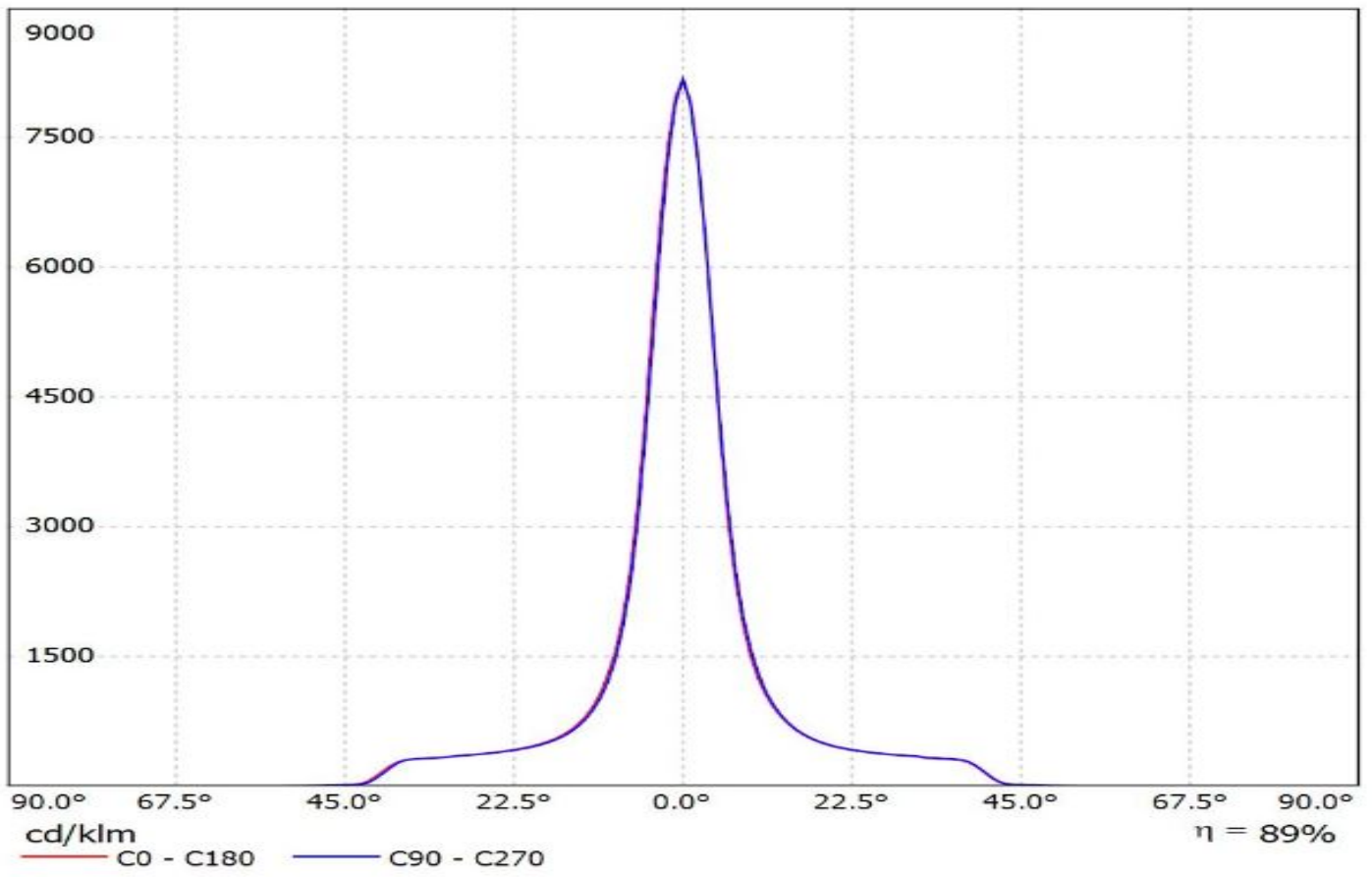

Luminaire: Ledil F14532\_ANGELETTE-S\_(NVCLL024Z+TE)  
Lamps: 1 x Nichia\_NVCLL024Z\_+2213382-2\_+2213194-  
1\_971.485lm@250mA\_CCT=3000K\_P=8W\_I=0.25A

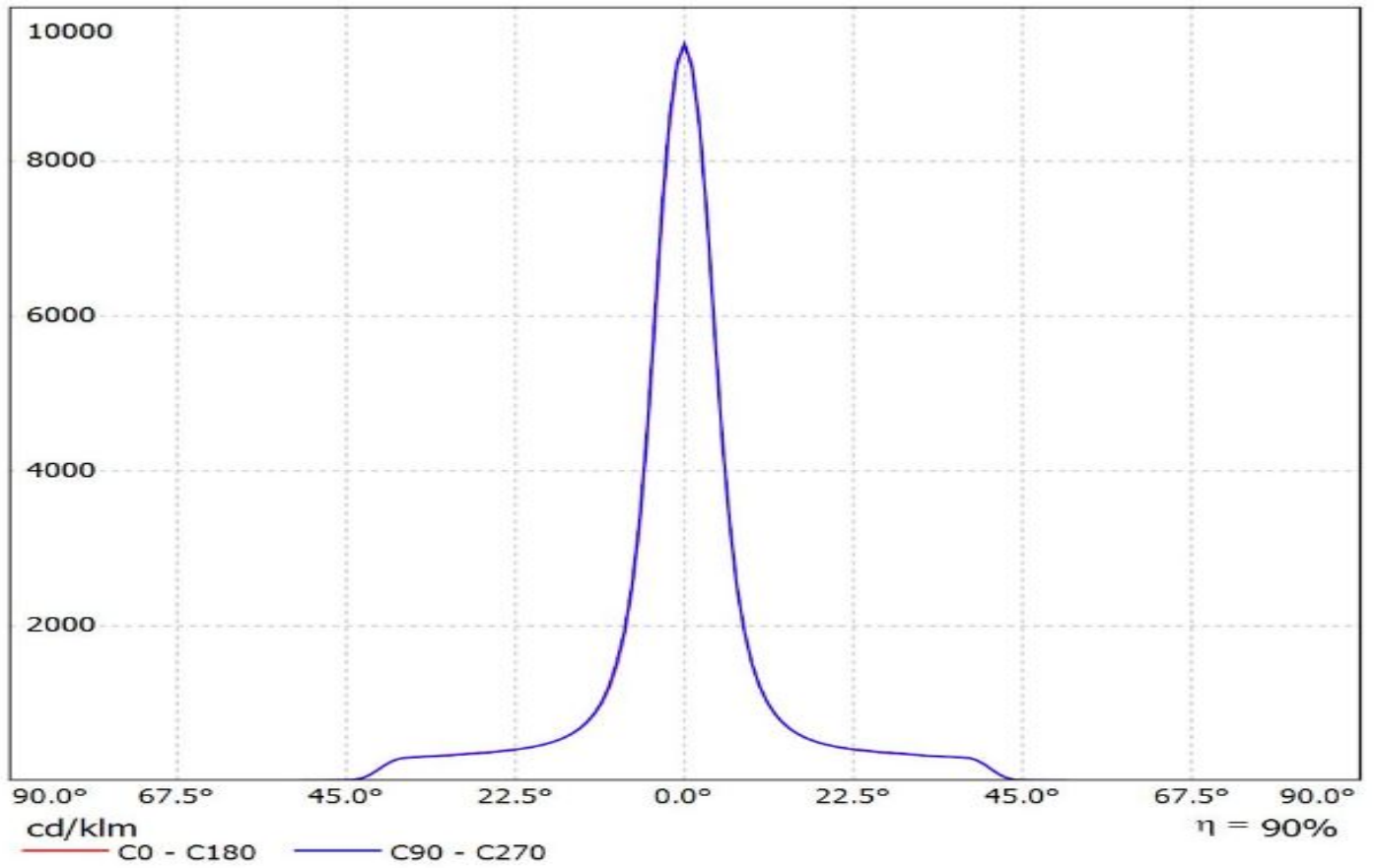



Luminaire: LEDiL Oy F14532\_ANGELETTE-S\_(NFDLJ130B+IDEAL)

Lamps: 1 x Nichia\_NFDLJ130B\_+50-2103NC\_+50-2100AN\_1422.52lm@250mA\_CCT=4000K\_P=8.91686W\_I=0.25A

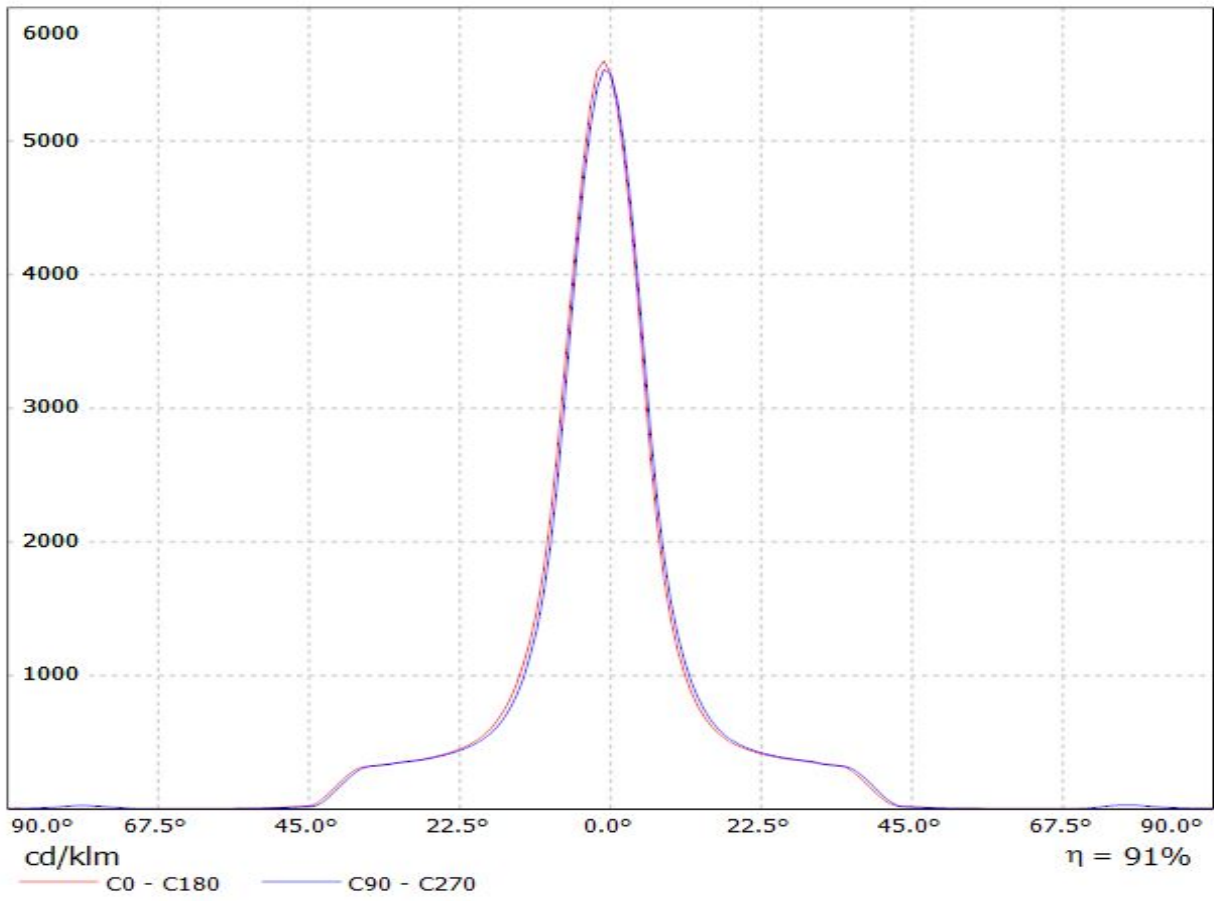

Luminaire: Ledil F14532\_ANGELETTE-S (PREVALED\_Core\_Z4)  
Lamps: 1 x PREVALED\_Core\_Z4\_LES19\_1470.62lm@250mA\_P=10.828W\_I=0.25A

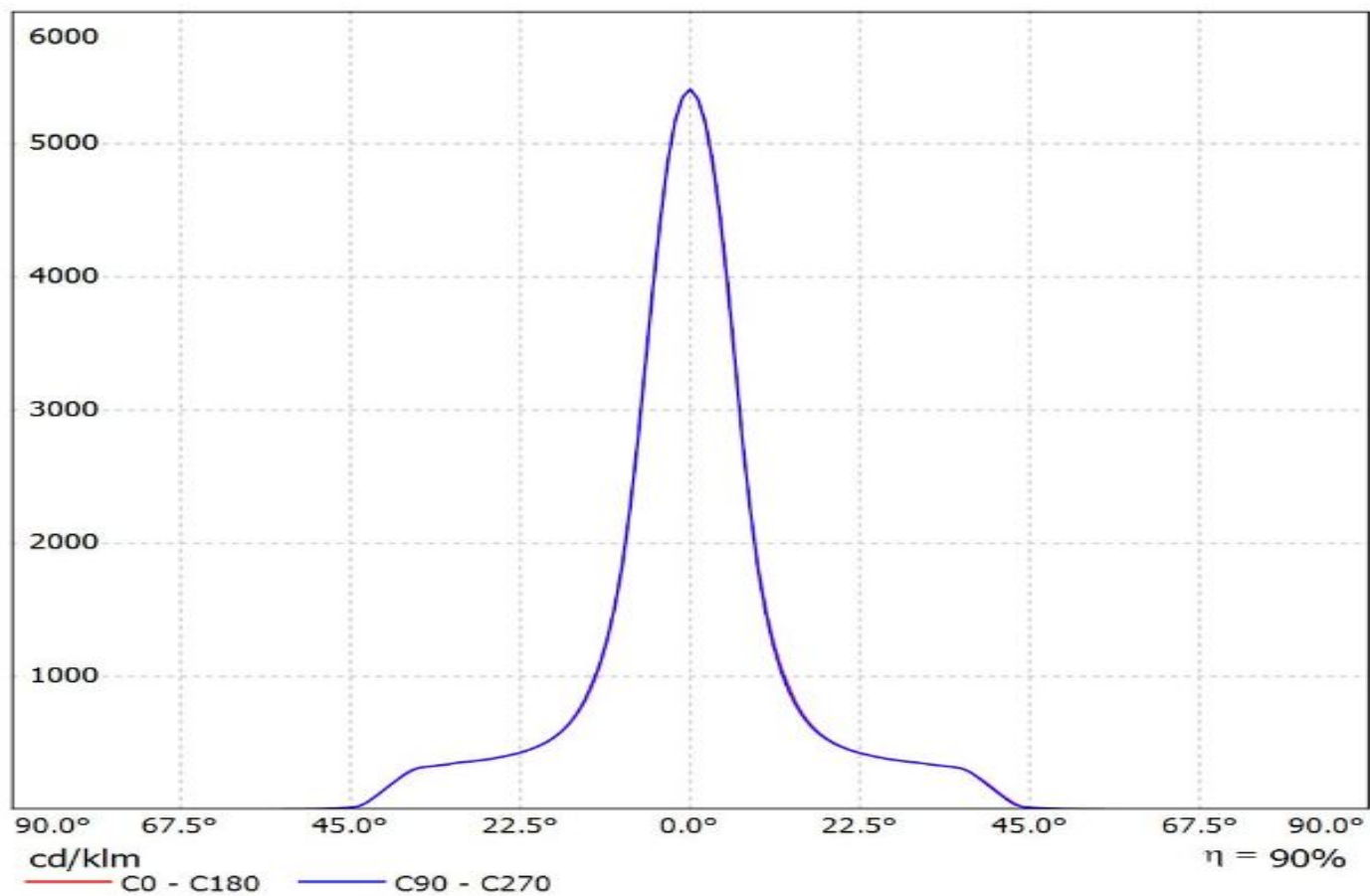

Luminaire: Ledil F14532\_ANGELETTE-S\_(S19+TE)

Lamps: 1 x Osram\_Solericq\_S19\_(GW\_KAHJB1.EM)\_+2213407-2+2213194-1\_1546.1lm@250mA\_CCT=3000K\_P=11.021W\_I=0.25A

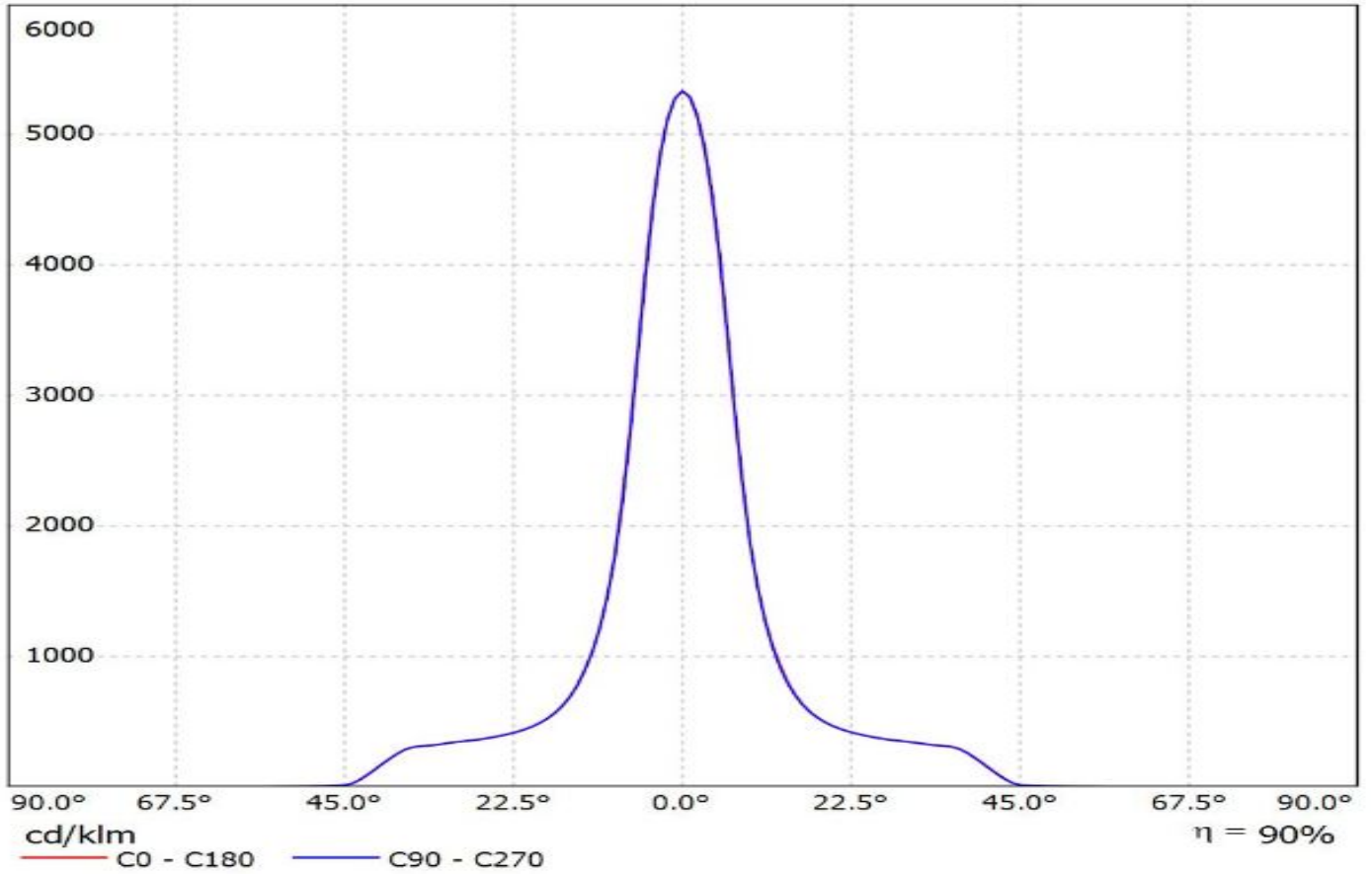

Luminaire: Ledil F14532\_ANGELETTE-S\_(S13\_Gen2+TE)

Lamps: 1 x Soleriq\_S13\_Gen2+\_2213254-2+\_2213194-1\_1309.23lm@250mA\_P=8.7840W\_I=0.250A

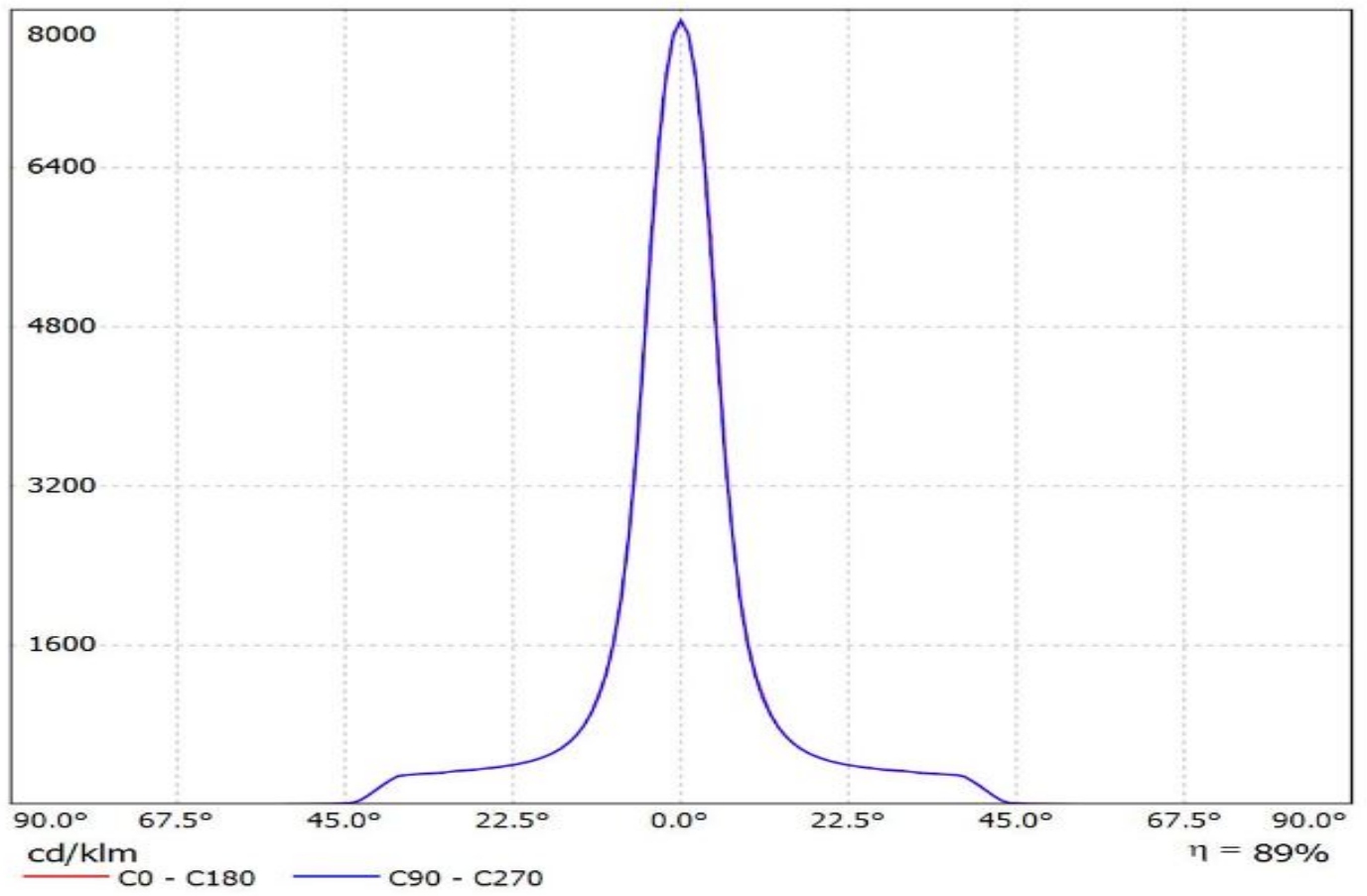

Luminaire: Ledil F14532\_ANGELETTE-S\_(S13\_Gen2+IDEAL)

Lamps: 1 x Soleriq\_S13\_Gen2+\_50-2103CT+\_50-2100AN\_1327.38lm@250mA\_P=8.7850W\_I=0.250A

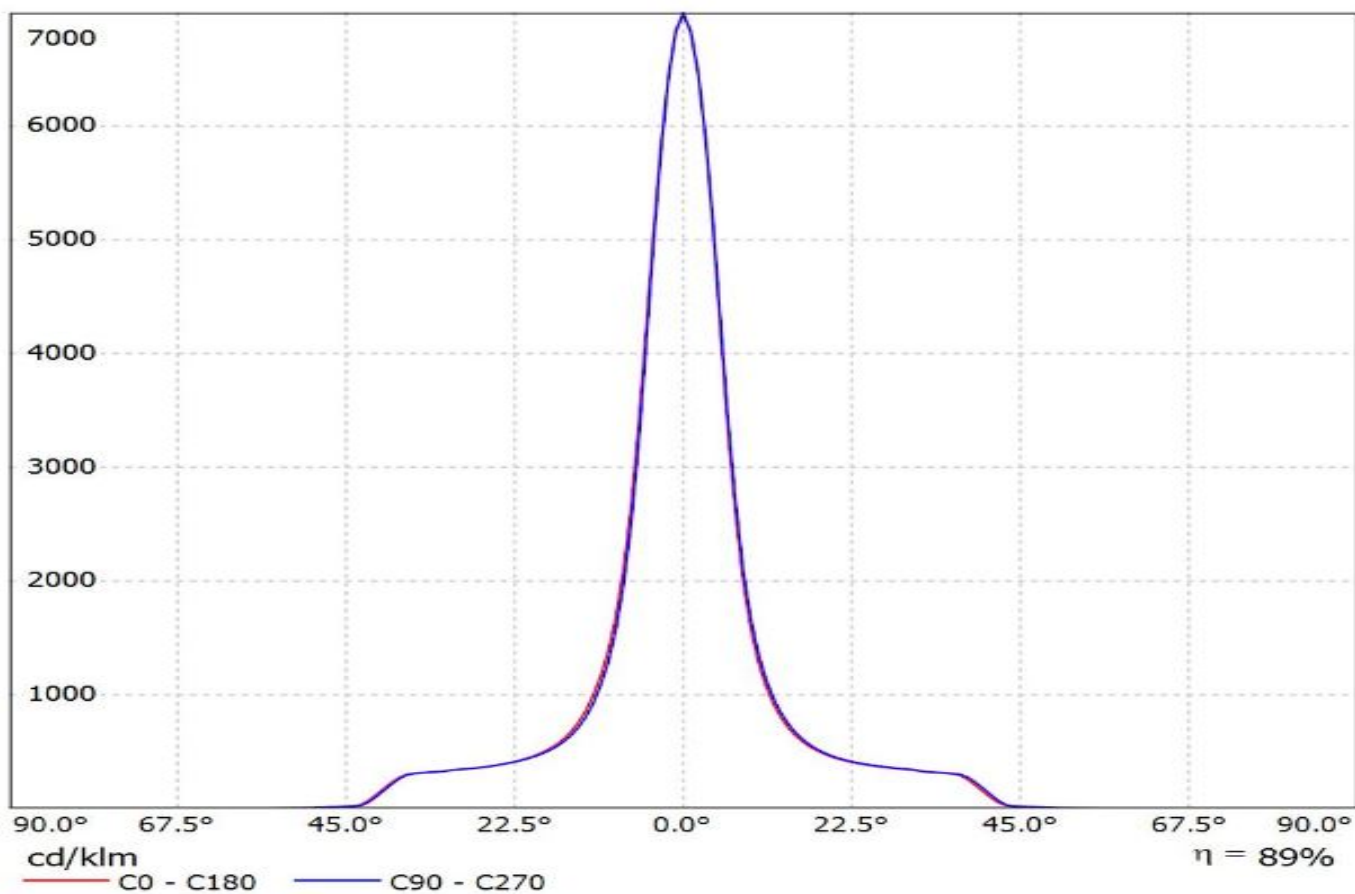

Luminaire: Ledil F14619\_ANGELETTE-S-PLAIN\_(S13\_Gen2+IDEAL)

Lamps: 1 x Soleriq\_S13\_Gen2+\_50-2103CT+\_50-2100AN\_1327.38lm@250mA\_P=8.7850W\_I=0.250A

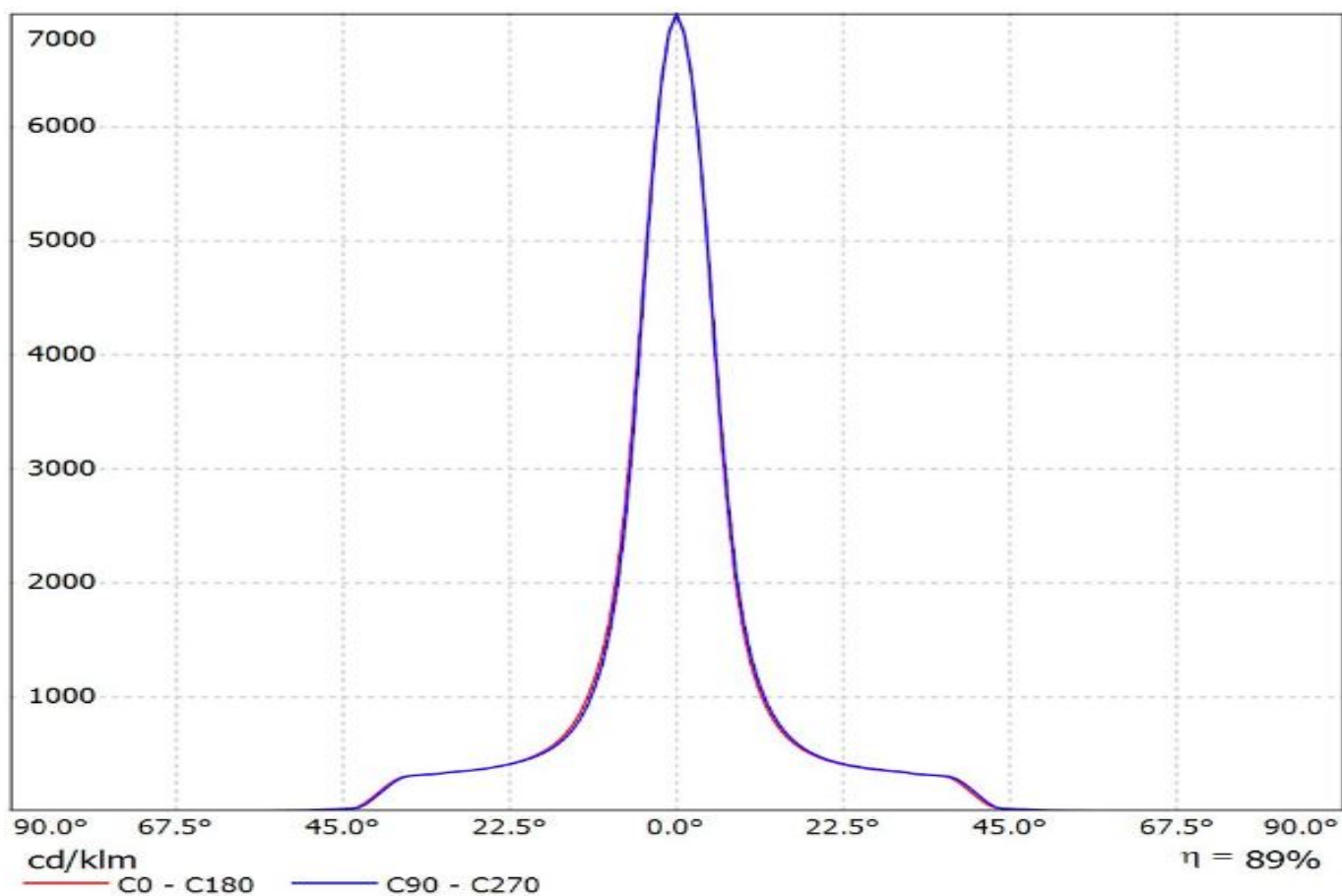

Luminaire: Ledil F14532\_ANGELETTE-S (SLM\_G5\_LES\_15\_+TE)

Lamps: 1 x Philips\_SLM\_G5\_LES\_15\_+TE\_2213194-1\_1277.72lm@250mA\_P=8.208W\_I=0.25A

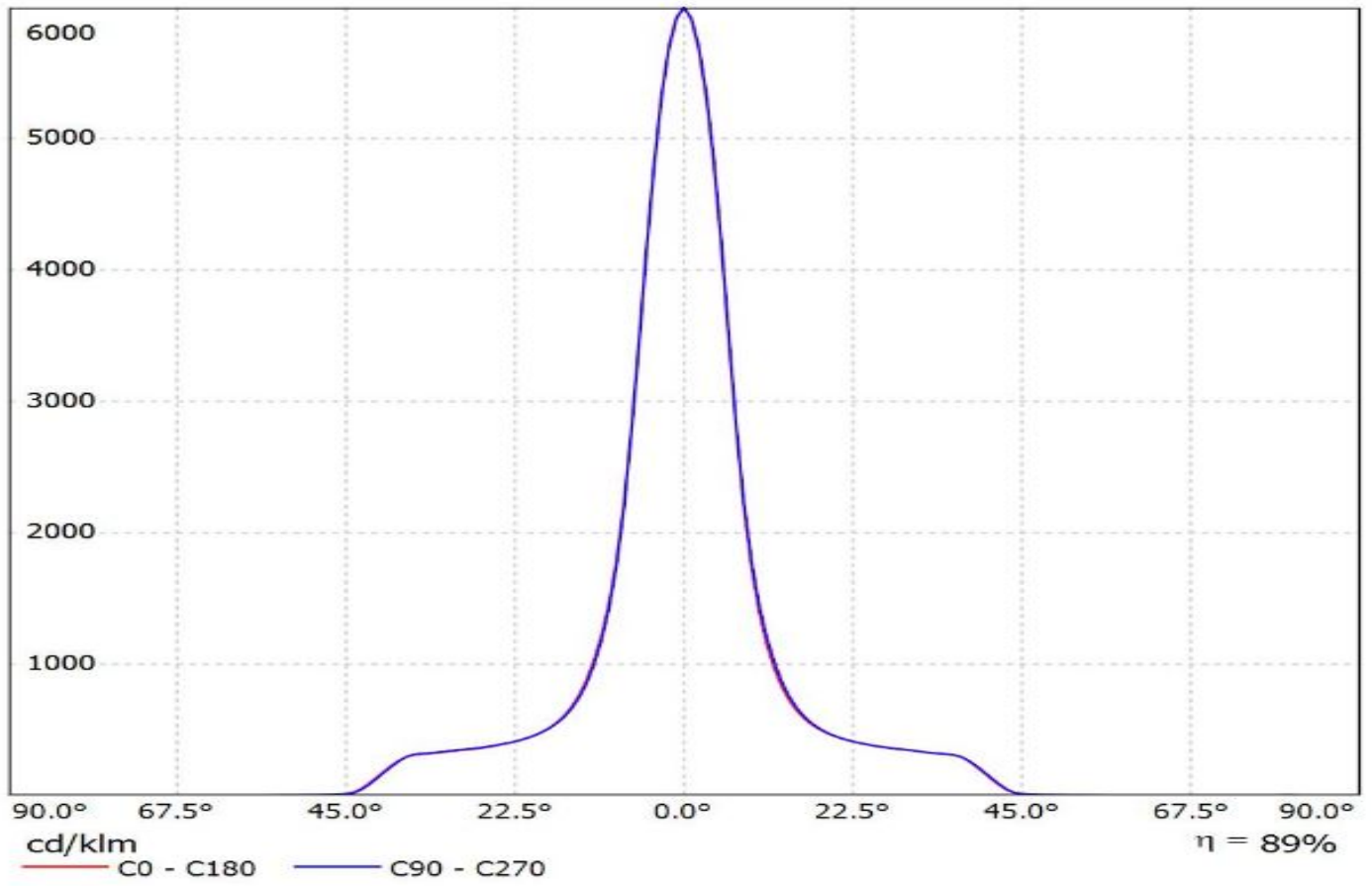

Luminaire: Ledil F14532\_ANGELETTE-S\_(LC040C+TE)

Lamps: 1 x Samsung\_LC040C+\_2213382-2+\_2213194-1\_1194.16lm@250mA\_CCT=4000K\_P=8.137W

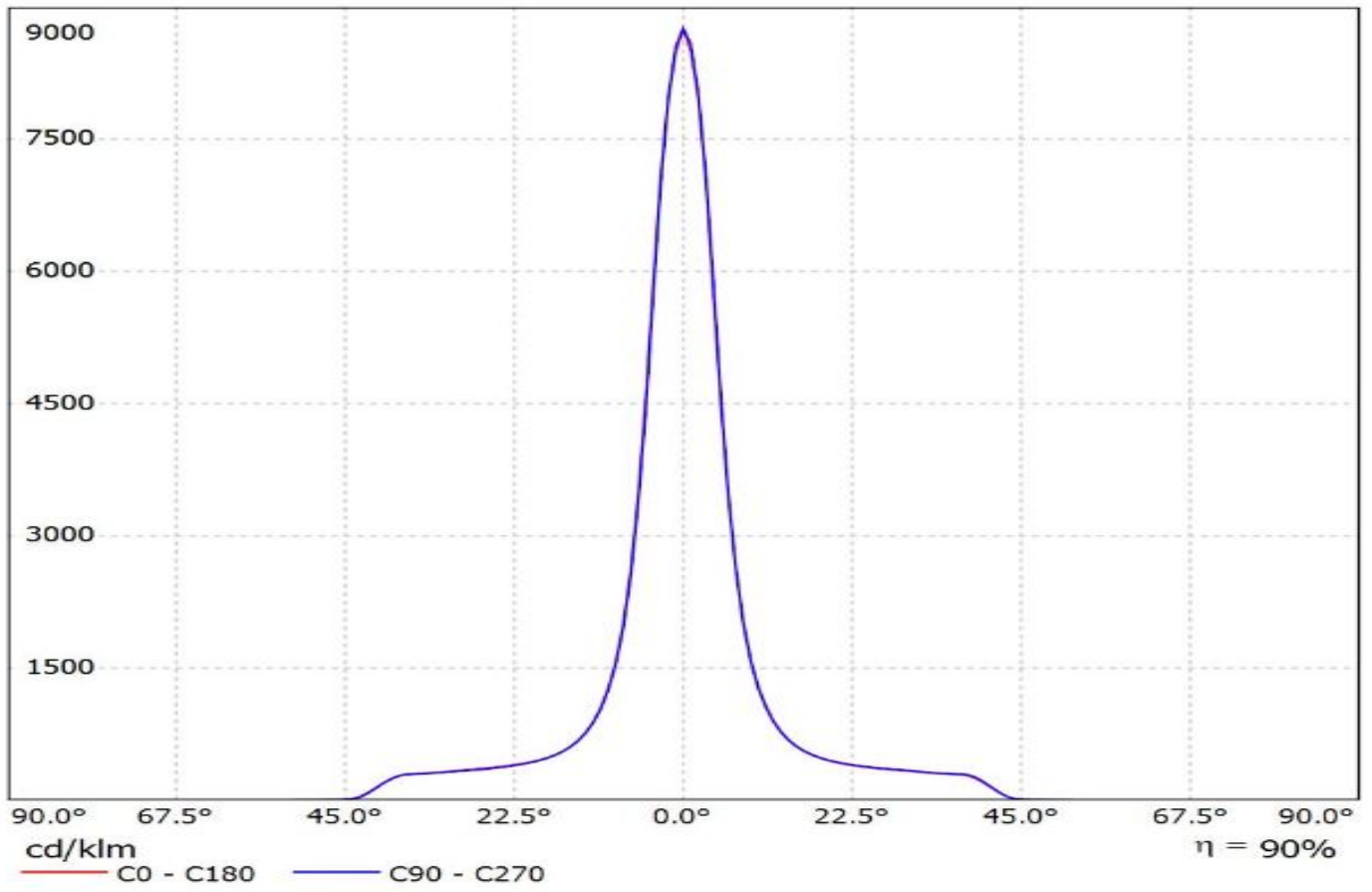



Luminaire: Ledil F14532\_ANGELETTE-S\_(MJT\_30W\_Les14,5)\_TE

Lamps: 1 x Seoul\_MJT\_30W\_Les14,5mm\_(SAWx1566A)\_+TE\_2213254-2\_+\_TE\_2213194-1\_1328.6lm@250mA\_P=8.24025W\_I=0.25A

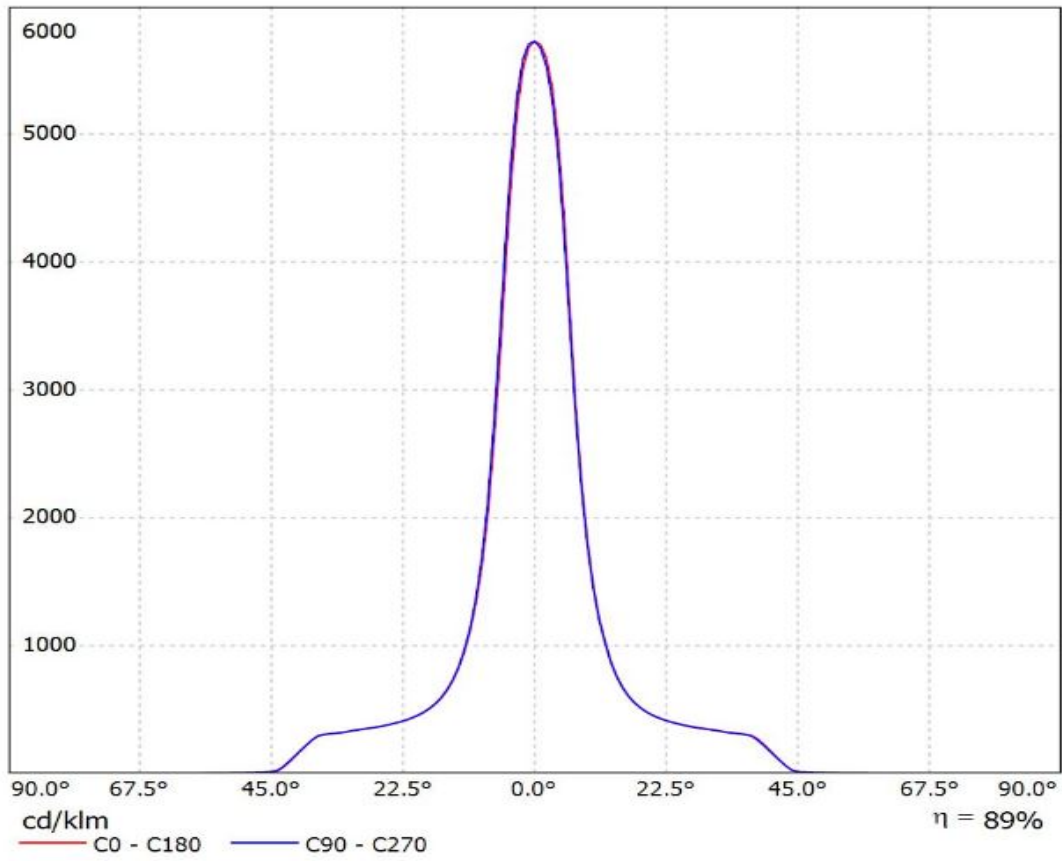

Luminaire: Ledil Oy F14532\_ANGELETTE-S\_(SLE\_G6\_LES15)\_(2213254-2\_+\_2213194-1)\_SIMULATED  
Lamps: 1 x Tridonic SLE G6 LES15 + Tyco Electronics 2213254-2 + TE 2213194-1 Optic clip

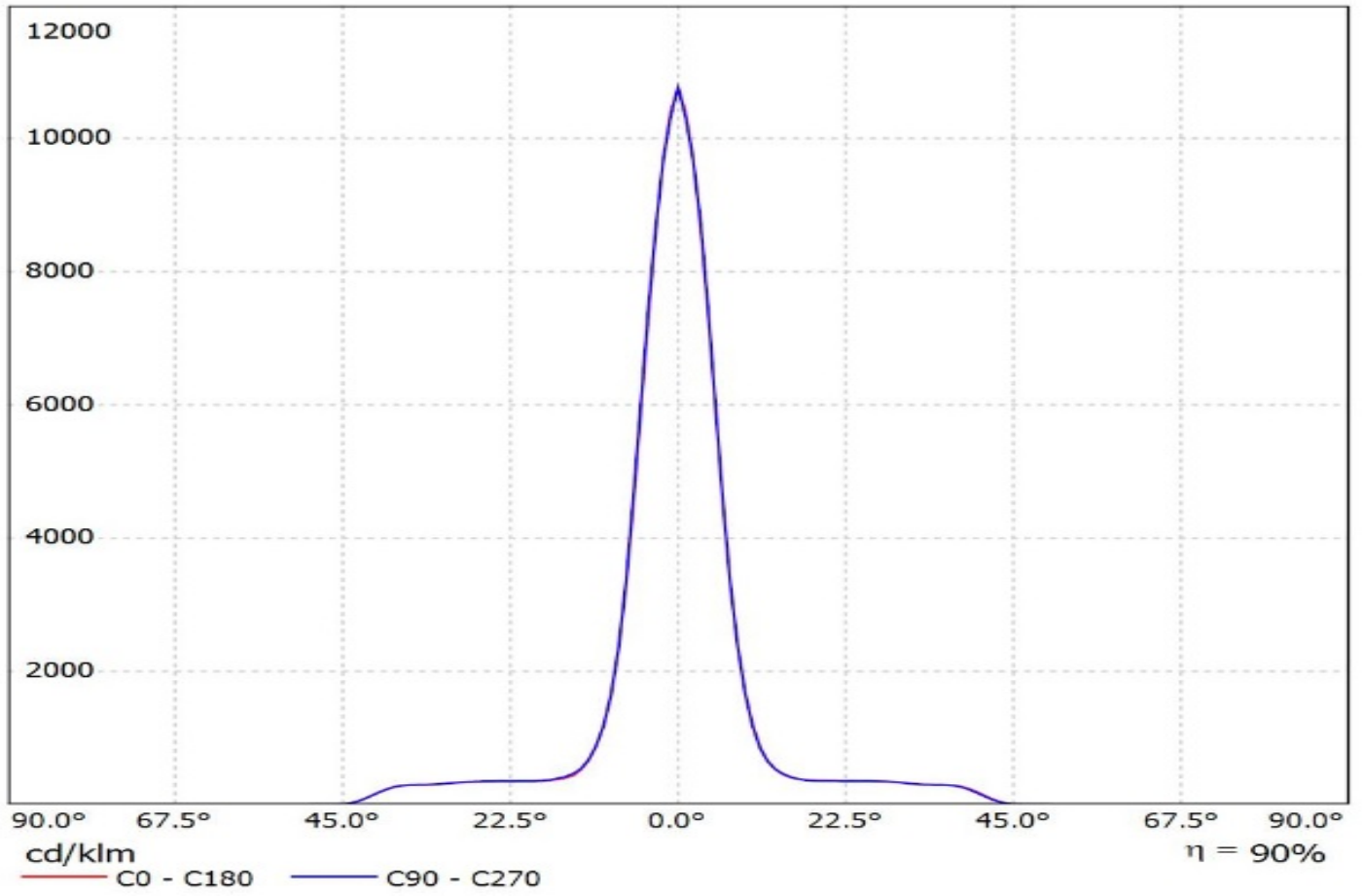

Luminaire: Ledil Oy F14532\_ANGELETTE-S+\_TE\_2213254-2+\_TE\_Z50\_Type1\_TRIDONIC\_SLE\_G6\_LES17\_SIMULATED  
Lamps: 1 x TRIDONIC SLE G6 LES17

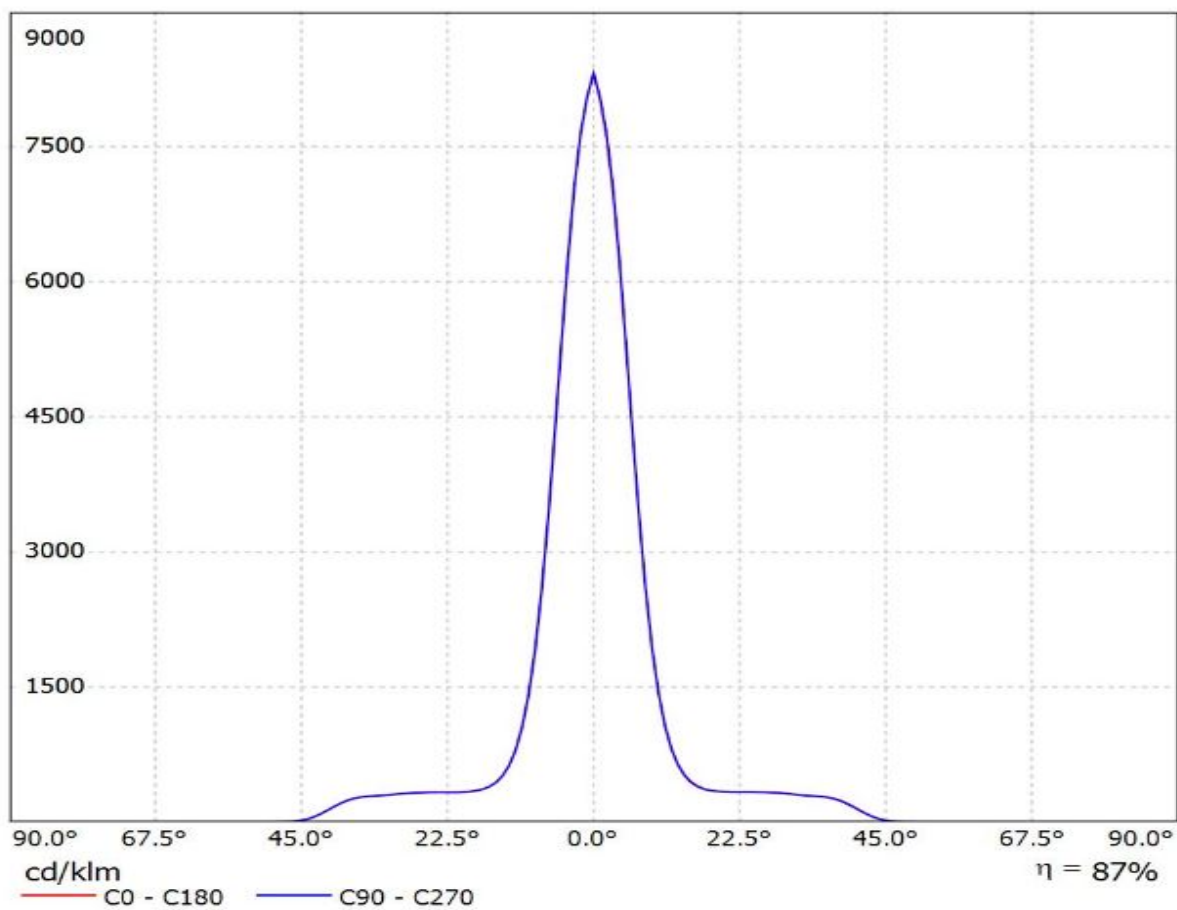

Luminaire: Ledil F14532\_ANGELETTE-S\_(WU-M-484+TE)

Lamps: 1 x Vossloh\_Schwabe\_WU-M-484-830\_681.21lm@250mA\_P=5.6195W\_I=0.25A

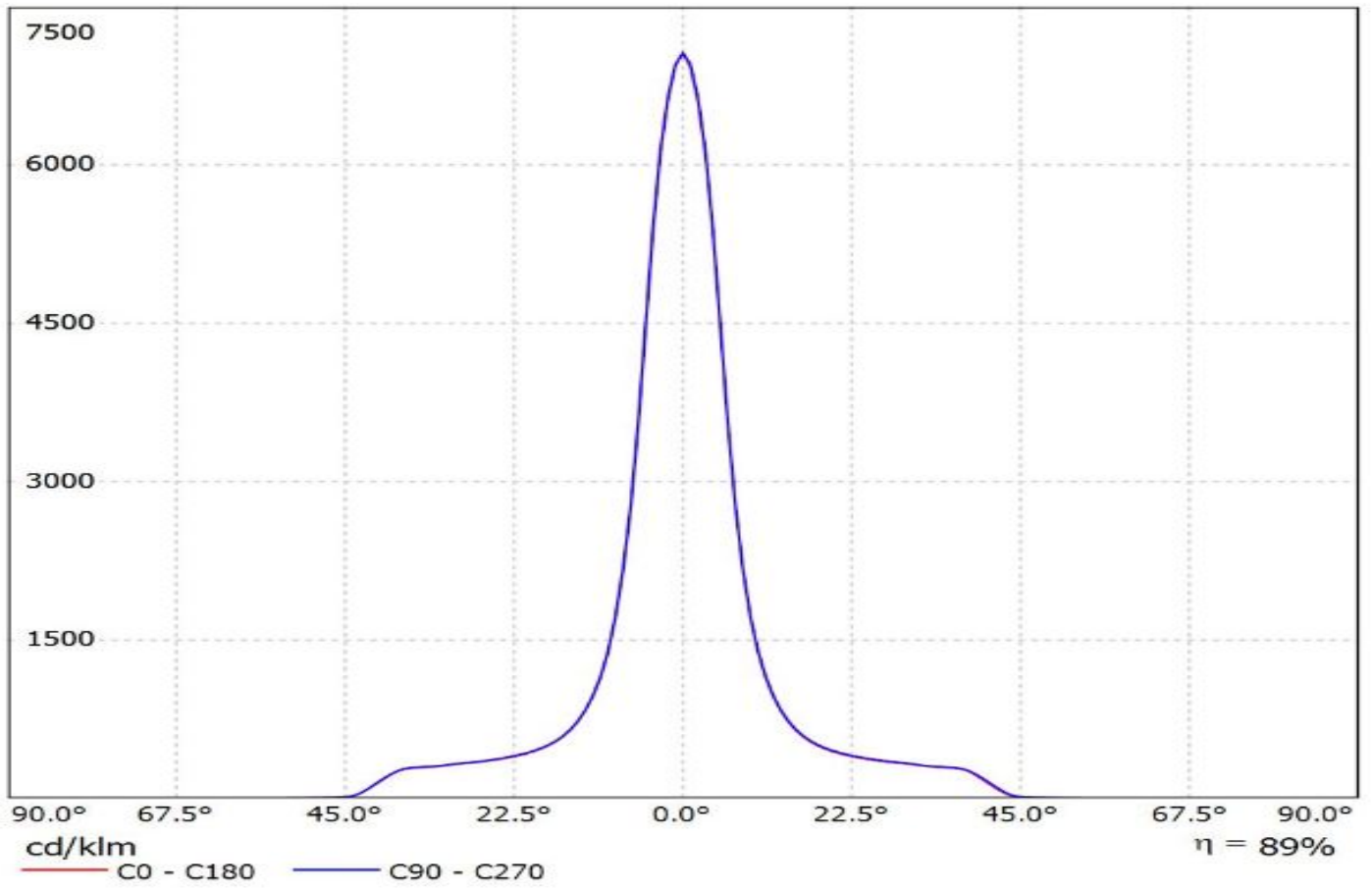

Luminaire: Ledil F14532\_ANGELETTE-S\_(V22+IDEAL)  
Lamps: 1 x Bridgelux\_V22\_(BXRE30E6500H-Y2)\_+50-2204CT\_+\_50-2100AN\_1193.54lm@250mA\_CCT=3000K\_P=8.0988W\_I=0.25A

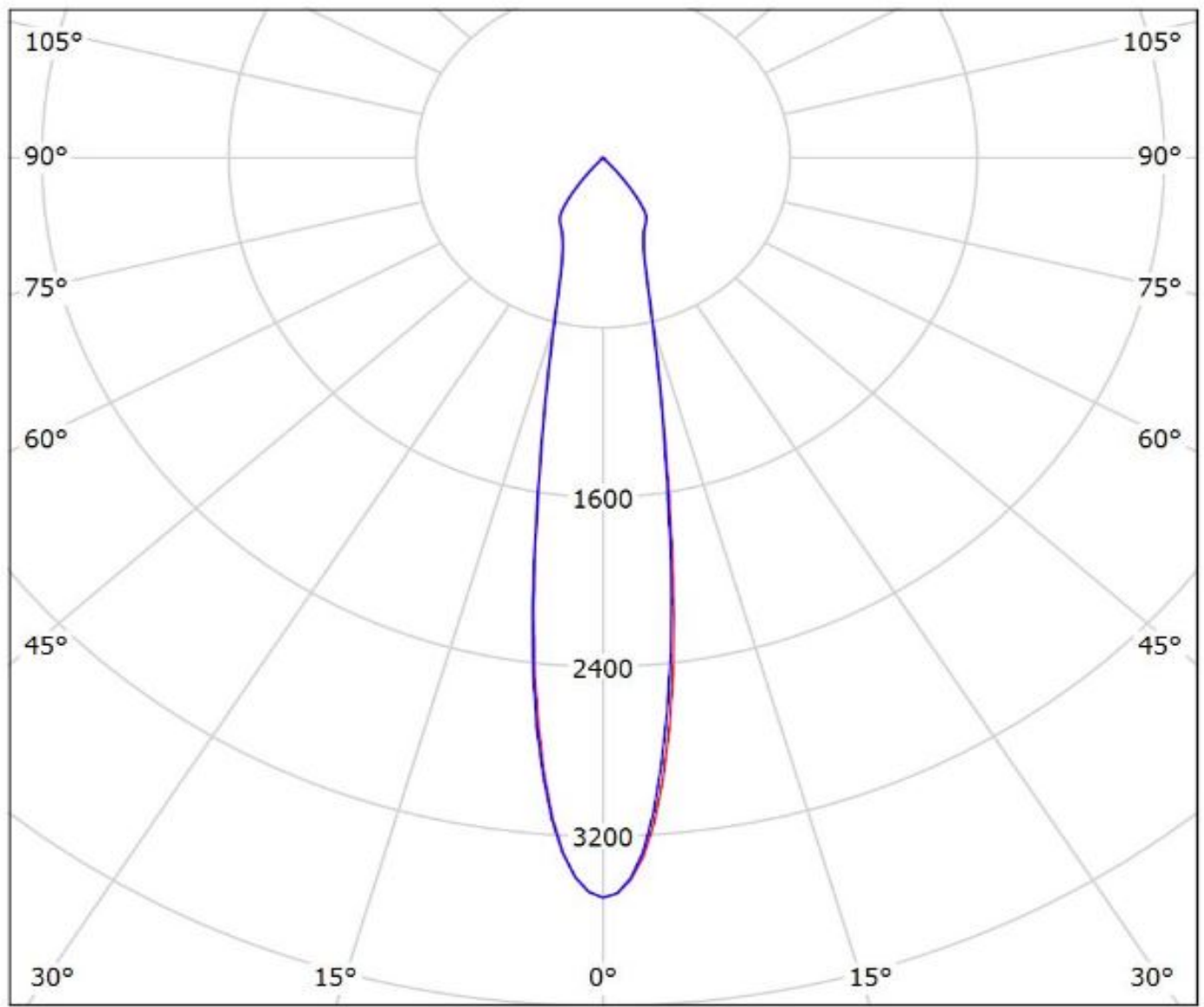

cd/klm  
— C0 - C180 — C90 - C270

$\eta = 90\%$

Luminaire: LEDiL Oy F14532\_ANGELETTE-S\_(V13\_Gen7)+TE

Lamps: 1 x Bridgelux\_V13\_Gen7\_(BXRE-30E2000-B\_+TE\_2213254-2+TE\_2213194-1)\_1295.55lm@250mA\_P=8.30985W\_I=0.25A

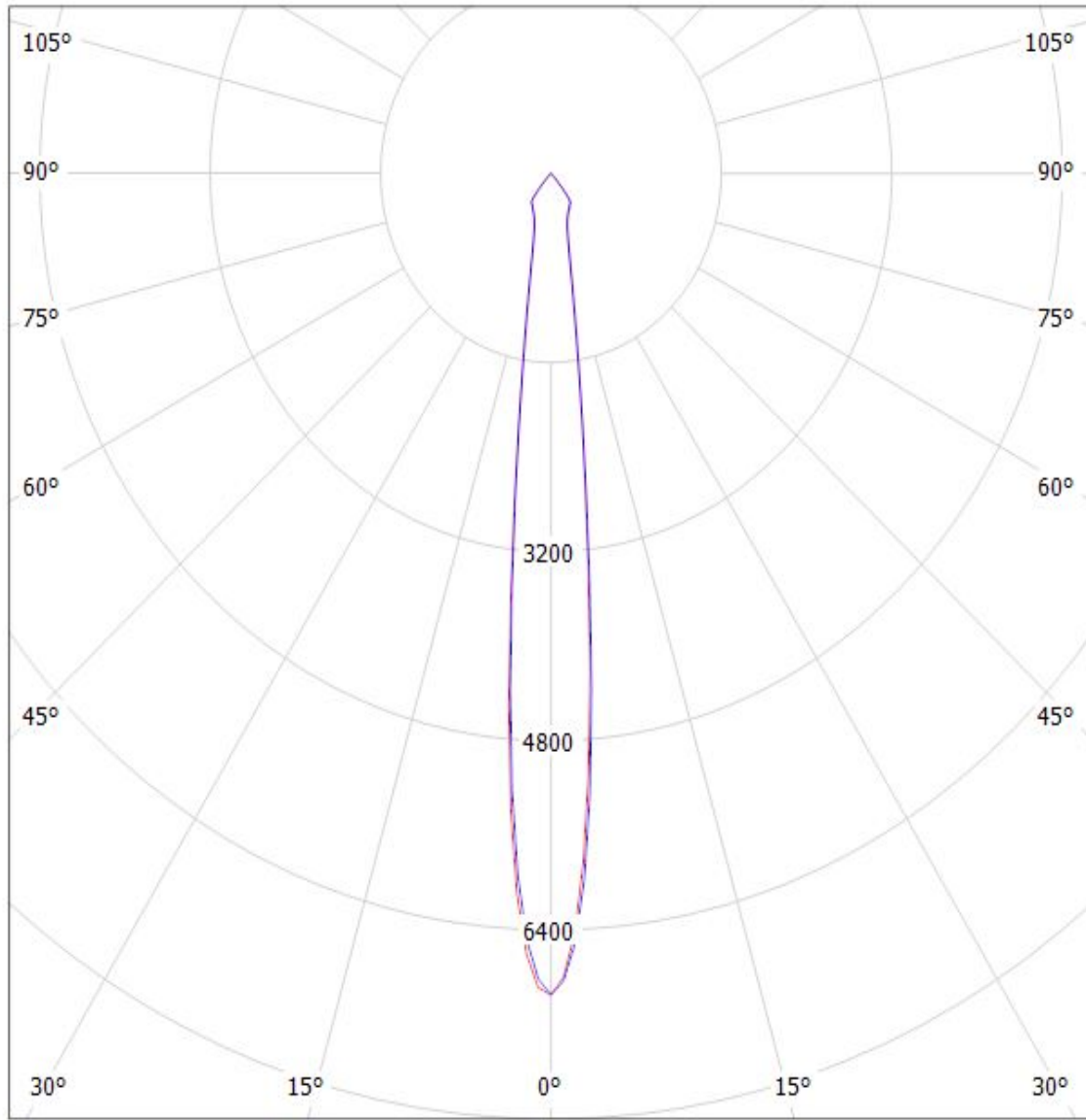

cd/klm

— C0 - C180 — C90 - C270

$\eta = 91\%$

Luminaire: Ledil Oy F14532\_ANGELETTE-S\_Bridgelux\_V22\_Gen7\_SIMULATED F14532\_ANGELETTE-S\_Bridgelux\_V22\_Gen7\_SIMULATED  
Lamps: 1 x F14532\_ANGELETTE-S\_Bridgelux\_V22\_Gen7\_SIMULATED

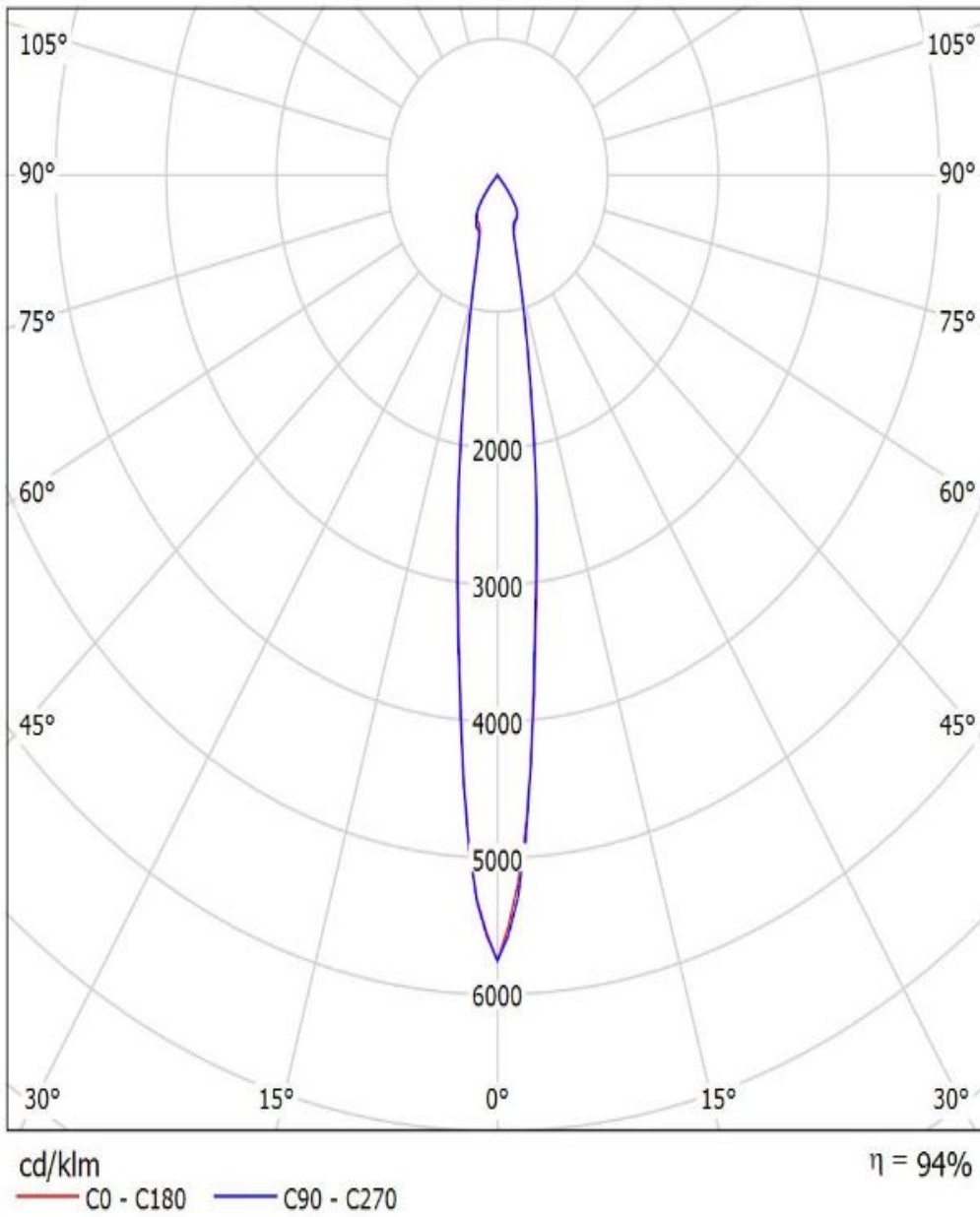

Luminaire: Ledil F14532\_ANGELETTE-S\_(CLU038+TE)  
Lamps: 1 x Citizen\_CLU038\_(-1205C4-273MZK1)\_+2213254-2\_+2213194-  
1\_1351.18lm@250mA\_P=8.4078W\_I=0.25A

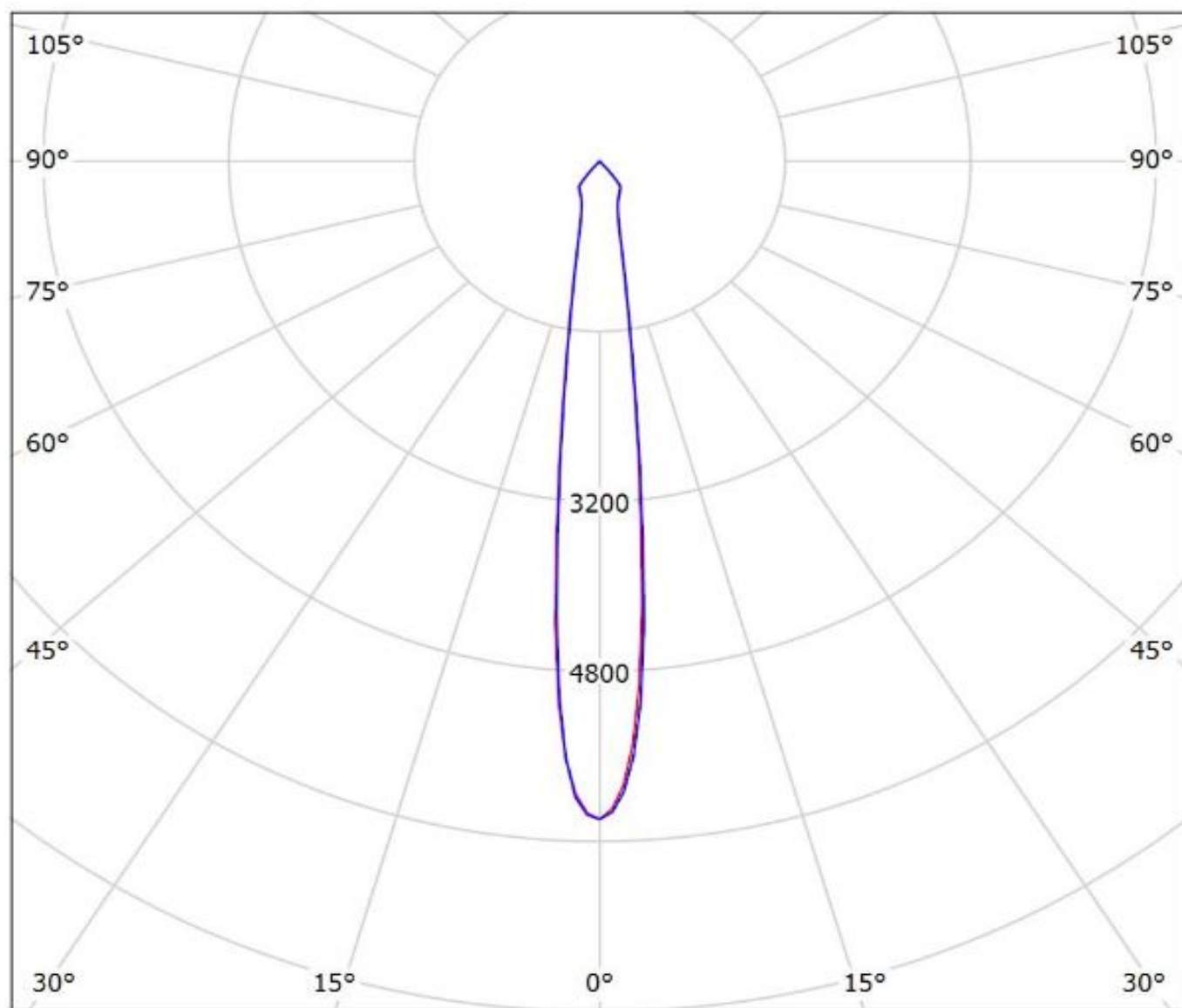

cd/klm

— C0 - C180

— C90 - C270

$\eta = 90\%$



Luminaire: Ledil F14532\_ANGELETTE-S\_(CLU046+IDEAL)

Lamps: 1 x Citizen\_CLU046\_(-1212C1-303M2G2)\_1383.92lm@250mA\_CCT=3000K\_P=8.122W\_I=0.25A

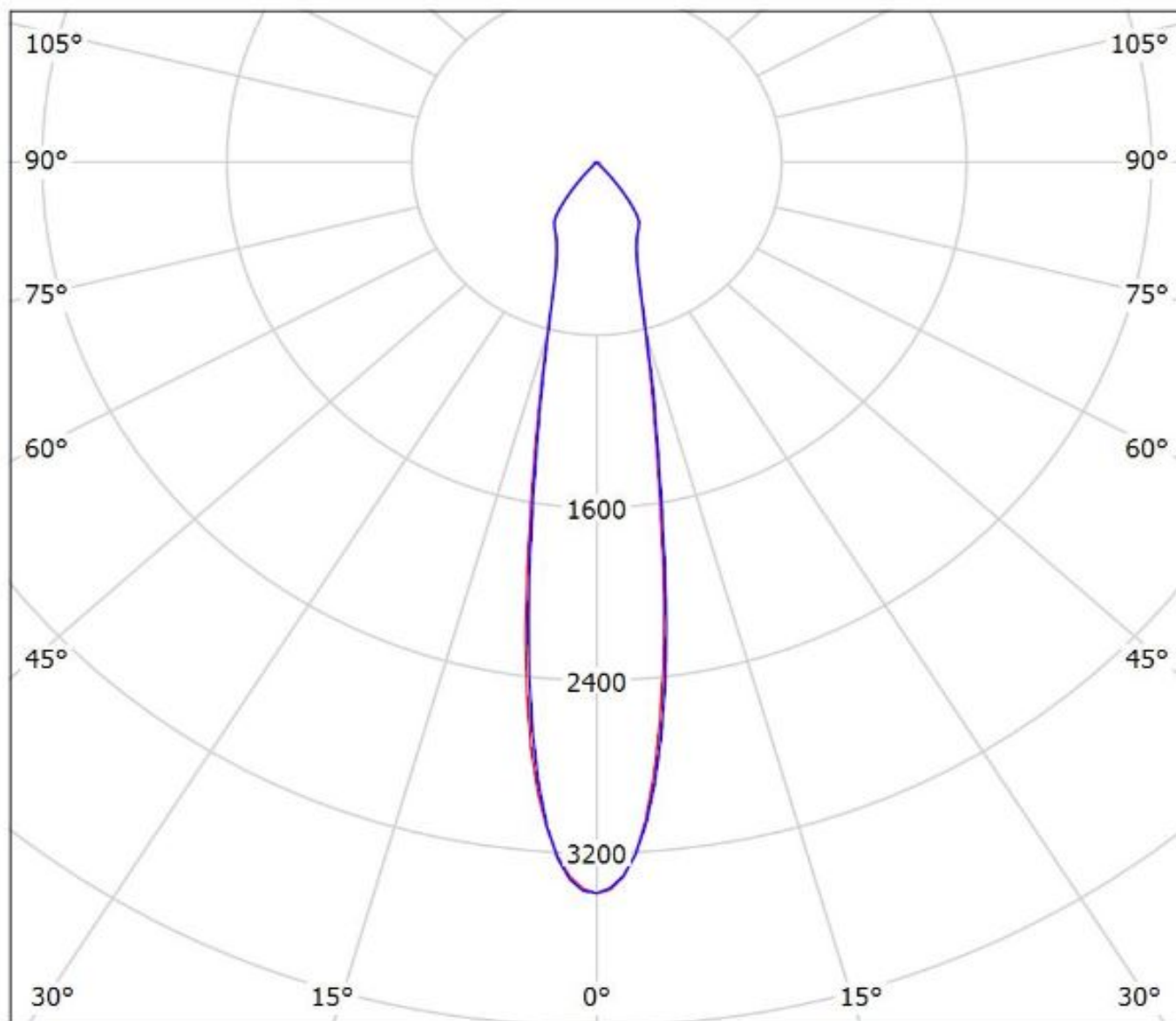

cd/klm

— C0 - C180

— C90 - C270

η = 89%

Luminaire: Ledil F14532\_ANGELETTE-S\_(CLU730+IDEAL)

Lamps: 1 x Citizen\_CLU730\_(-1210B8-273M2G1)\_IDEAL\_50-2204C+50-2100AN

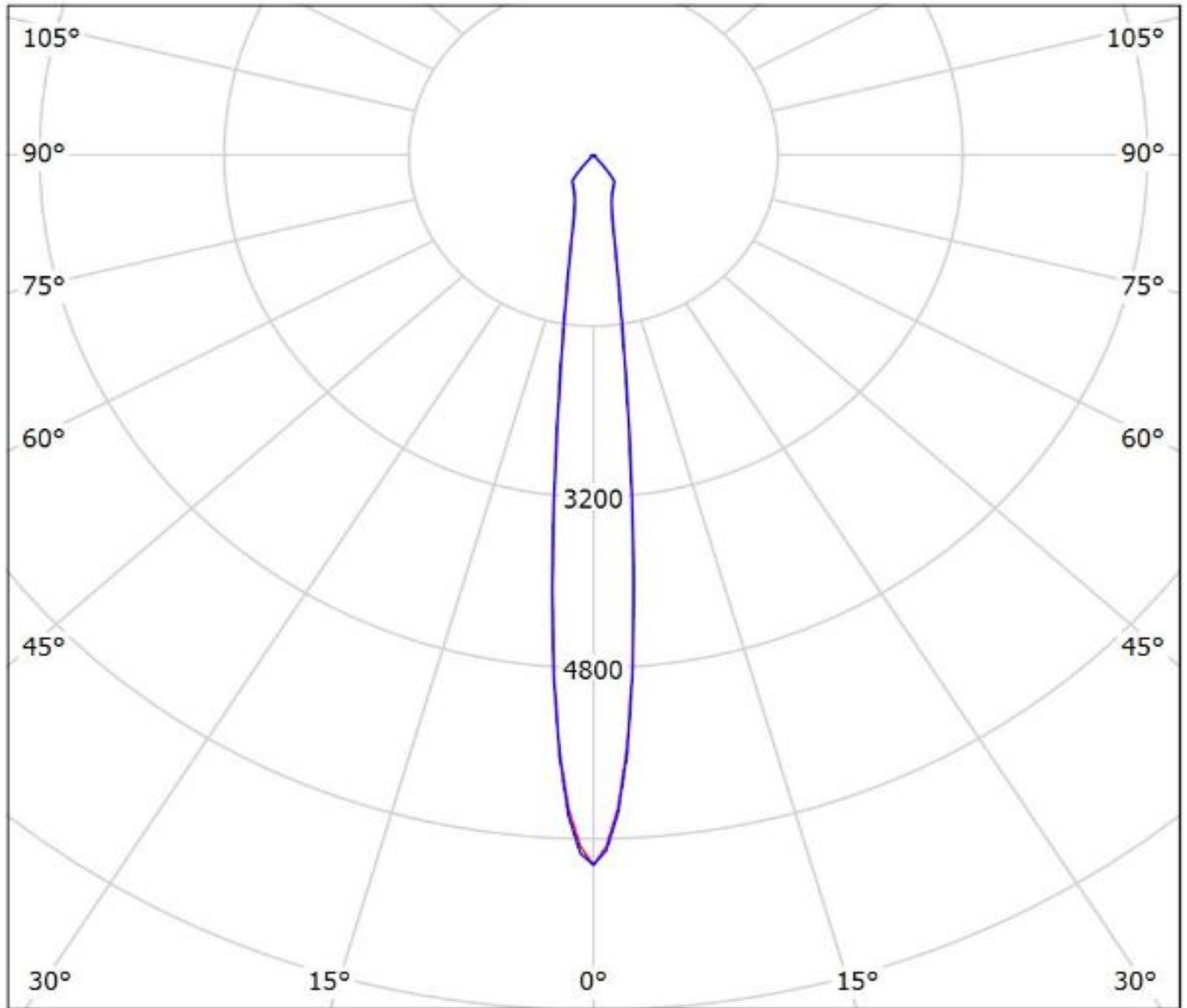

cd/klm

— C0 - C180

— C90 - C270

$\eta = 89\%$

Luminaire: Ledil F14532\_ANGELETTE-S\_(CLU036+IDEAL)  
Lamps: 1 x CITIZEN\_CLU036\_(-1208C1-303M2G2)\_IDEAL\_50-2103CT+50-2100AN\_1299.86lm@250mA\_CCT=3000K\_P=8.249W\_I=0.25A

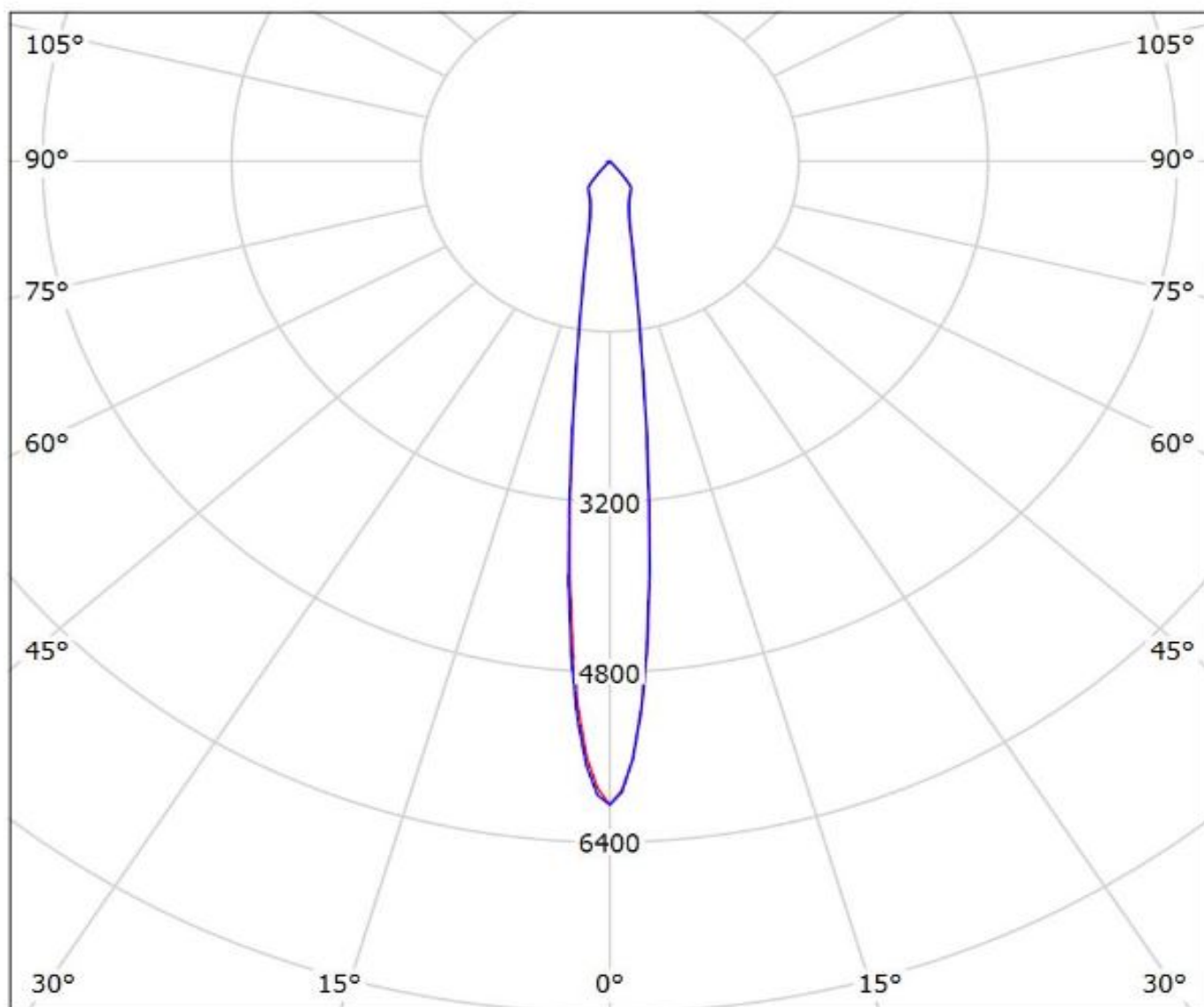

cd/klm

— C0 - C180 — C90 - C270

$\eta = 89\%$

Luminaire: Ledil F14532\_ANGELETTE-S\_(CoB1208+TE)  
Lamps: 1 x Luxeon\_CoB1208\_+\_2213130-2\_+\_2213194-  
1\_1055.15lm@250mA\_CCT=3000K\_P=8.3007W\_I=0.25A

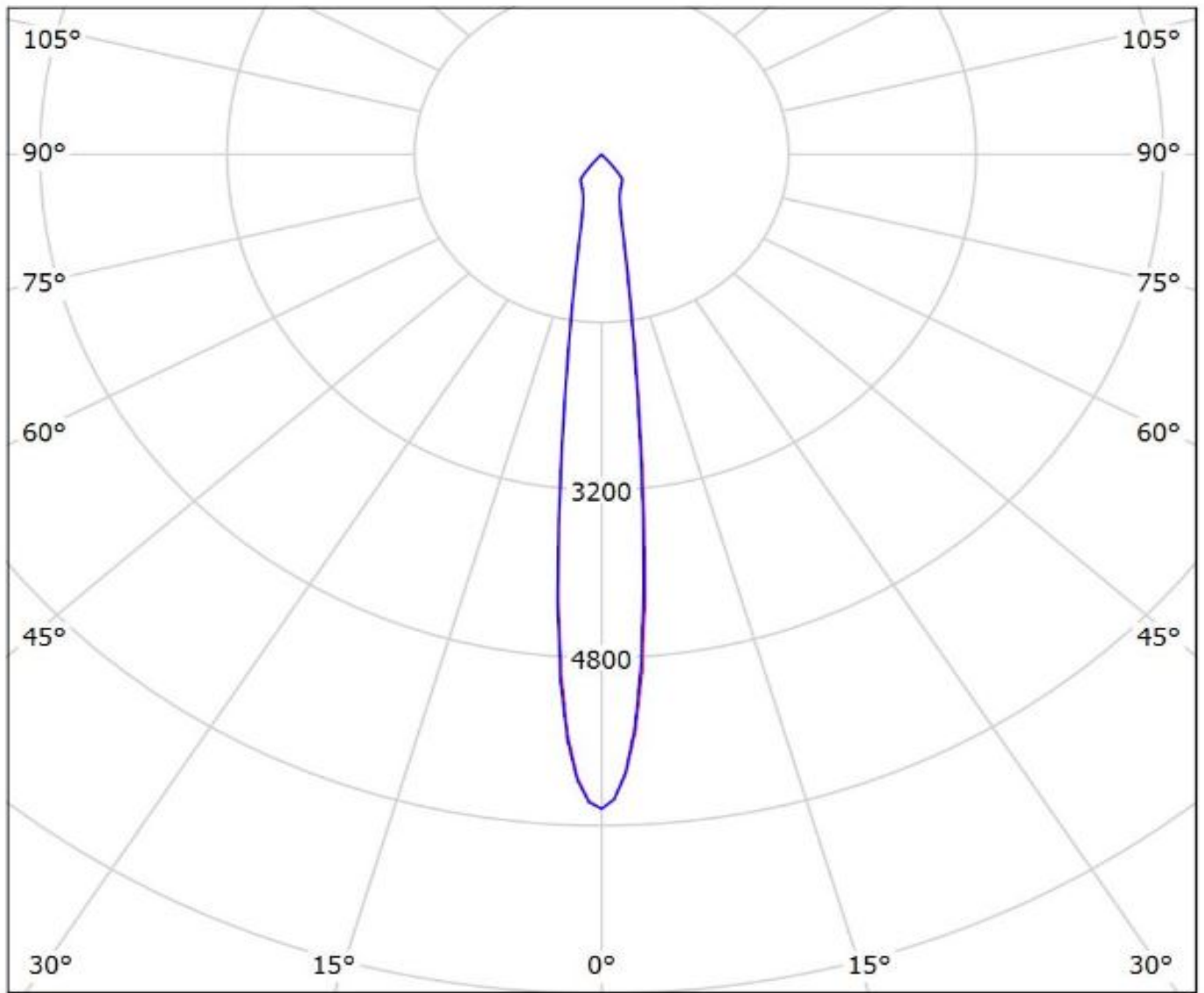

cd/klm

— C0 - C180 — C90 - C270

$\eta = 89\%$

Luminaire: Ledil F14532\_ANGELETTE-S\_(CoB1208+IDEAL)  
Lamps: 1 x Luxeon\_CoB1208 + 50-2100SH+50-2100AN\_1062.11lm@250mA\_CCT=3000K\_P=8.3007W\_I=0.25A

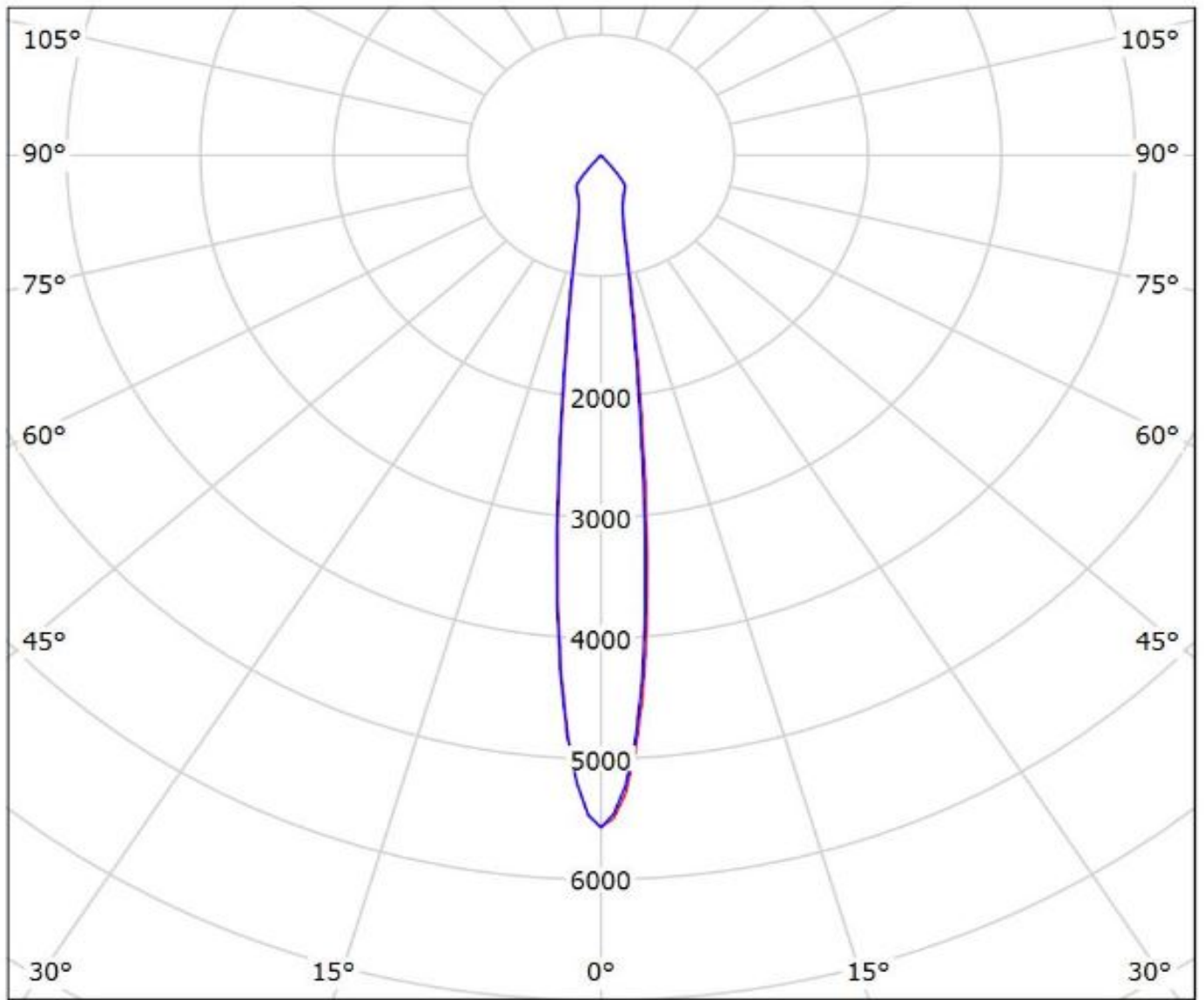

cd/klm  
— C0 - C180 — C90 - C270

$\eta = 89\%$

Luminaire: Ledil F14532\_ANGELETTE-S\_(CoB1211+IDEAL)  
Lamps: 1 x Luxeon\_CoB1211\_(L2C2-4080)\_50-2204CT+50-2100AN\_1376.18lm@250mA\_P=7.9988W\_I=0.25A

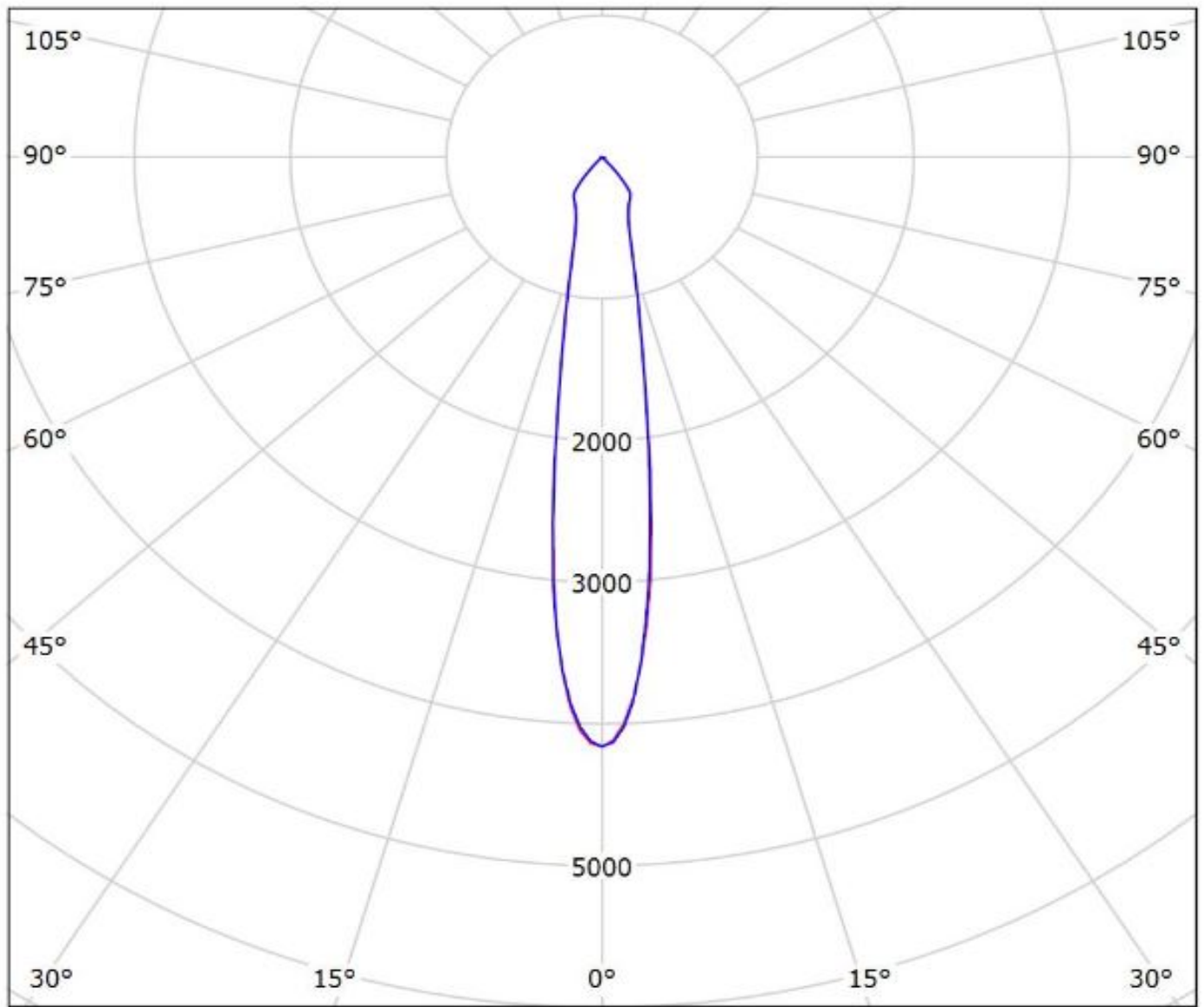

cd/klm

— C0 - C180 — C90 - C270

$\eta = 89\%$

Luminaire: Ledil F14532\_ANGELETTE-S\_(CoB1216\_IDEAL)  
Lamps: 1 x Luxeon\_CoB1216\_(L2C2-40801216E2300)\_+50-2204C+\_50-2100AN\_1447.57lm@250mA\_CCT=4000K\_P=8.0135W\_I=0.25A

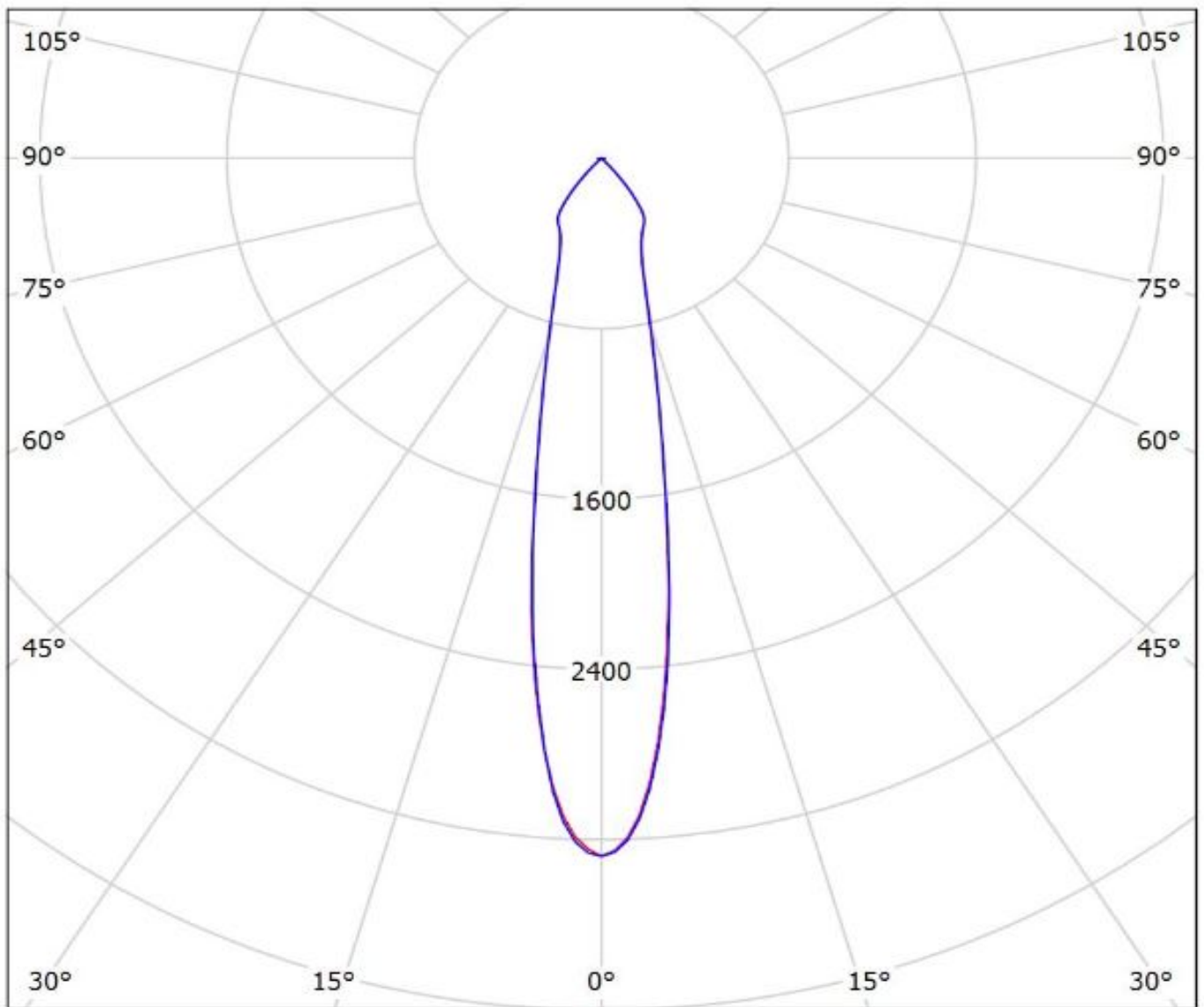

cd/klm

— C0 - C180 — C90 - C270

$\eta = 89\%$

Luminaire: Ledil F14532\_ANGELETTE-S\_(NVCLL024Z+IDEAL)

Lamps: 1 x Nichia\_NVCxL024z\_(NVCLL024z)\_975.455lm@250mA\_P=8.1468W\_I=250A

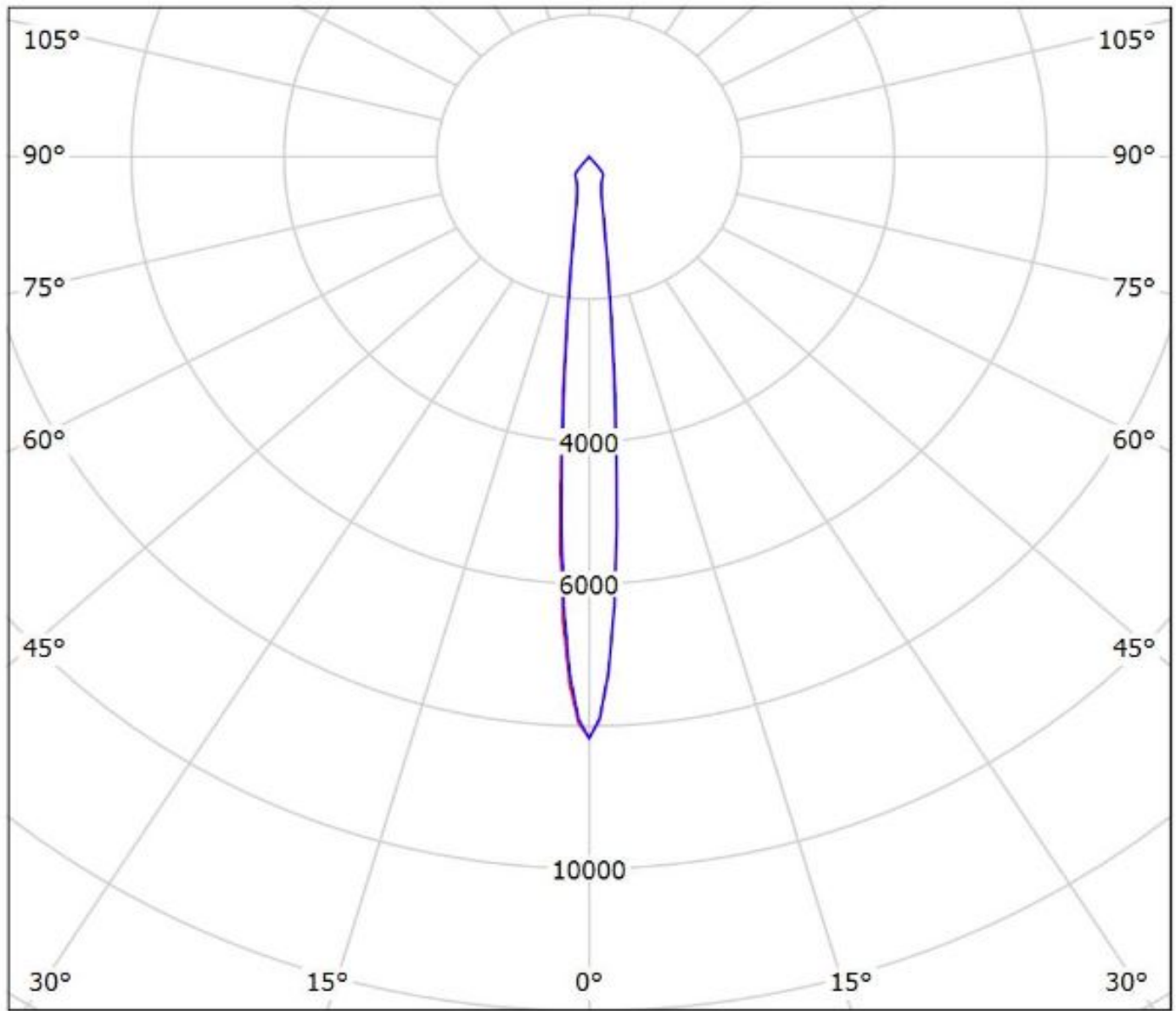

cd/klm

— C0 - C180 — C90 - C270

$\eta = 89\%$



Luminaire: Ledil F14532\_ANGELETTE-S\_(NVCLL024Z+TE)  
Lamps: 1 x Nichia\_NVCLL024Z\_+2213382-2\_+2213194-  
1\_971.485lm@250mA\_CCT=3000K\_P=8W\_I=0.25A

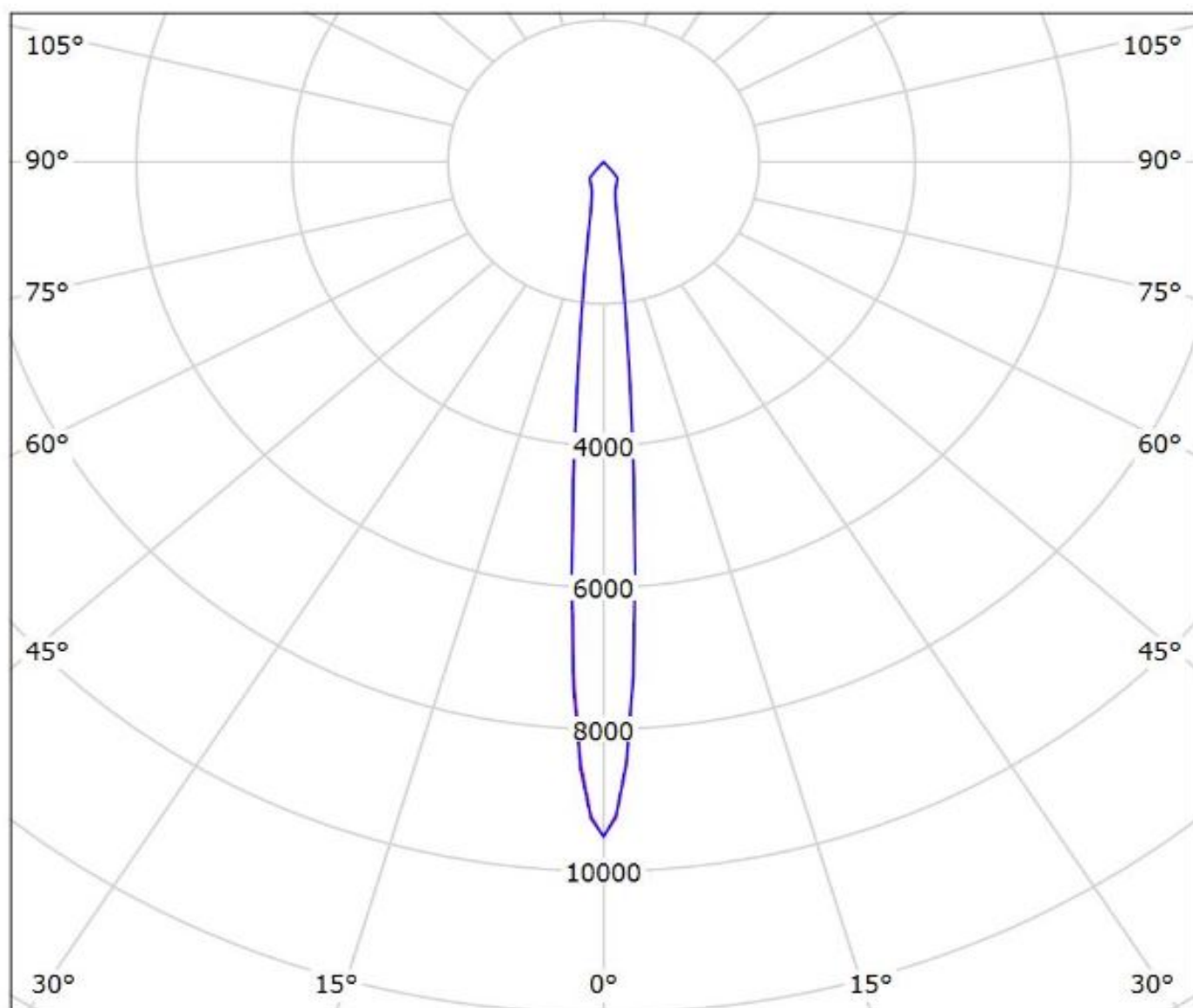

cd/klm

— C0 - C180 — C90 - C270

$\eta = 90\%$

Luminaire: LEDiL Oy F14532\_ANGELETTE-S\_(NFDLJ130B+IDEAL)

Lamps: 1 x Nichia\_NFDLJ130B\_+50-2103NC\_+50-2100AN\_1422.52lm@250mA\_CCT=4000K\_P=8.91686W\_I=0.25A

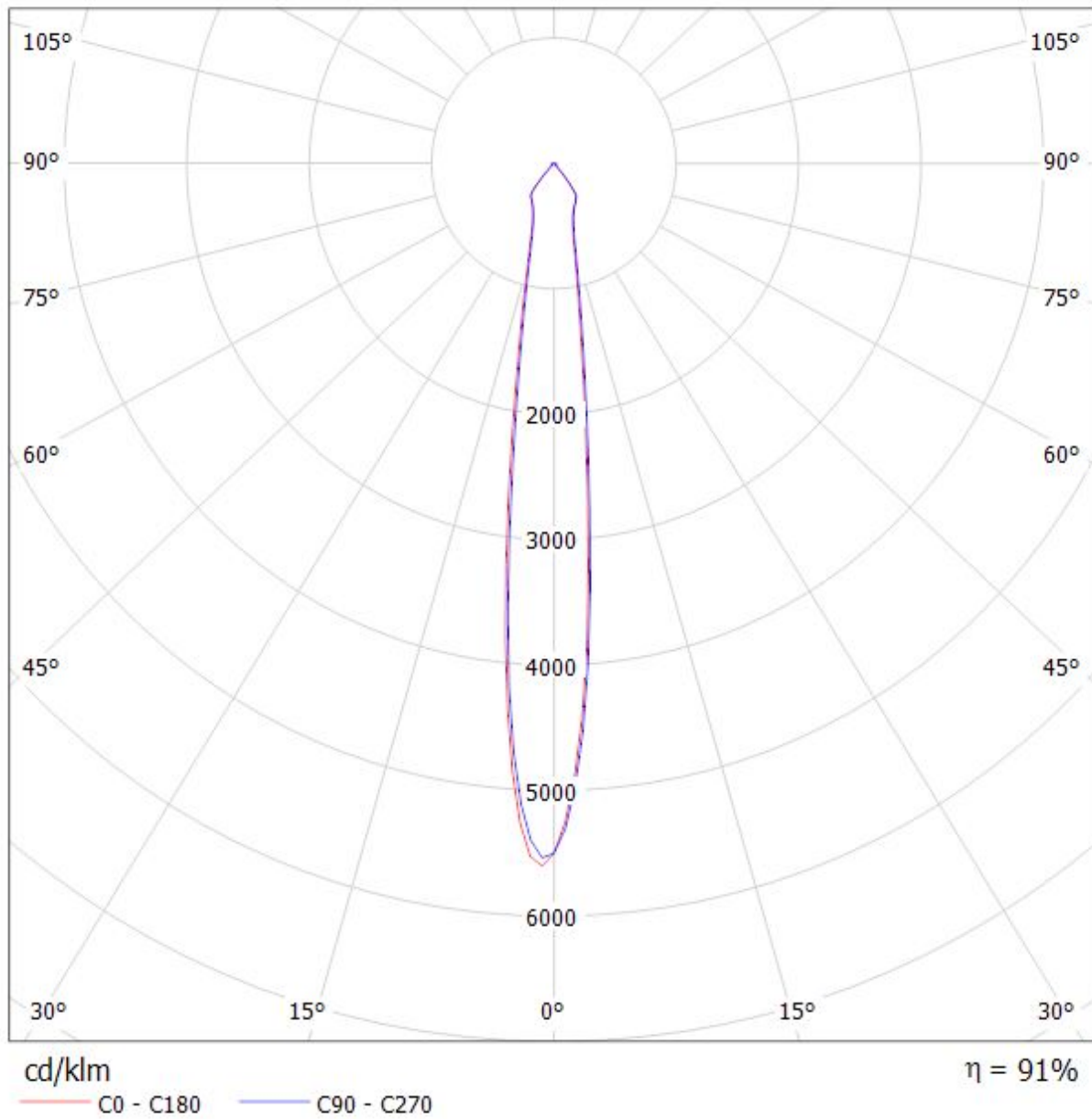

Luminaire: Ledil F14532\_ANGELETTE-S\_(PREVALED\_Core\_Z4)

Lamps: 1 x PREVALED\_Core\_Z4\_LES19\_1470.62lm@250mA\_P=10.828W\_I=0.25A

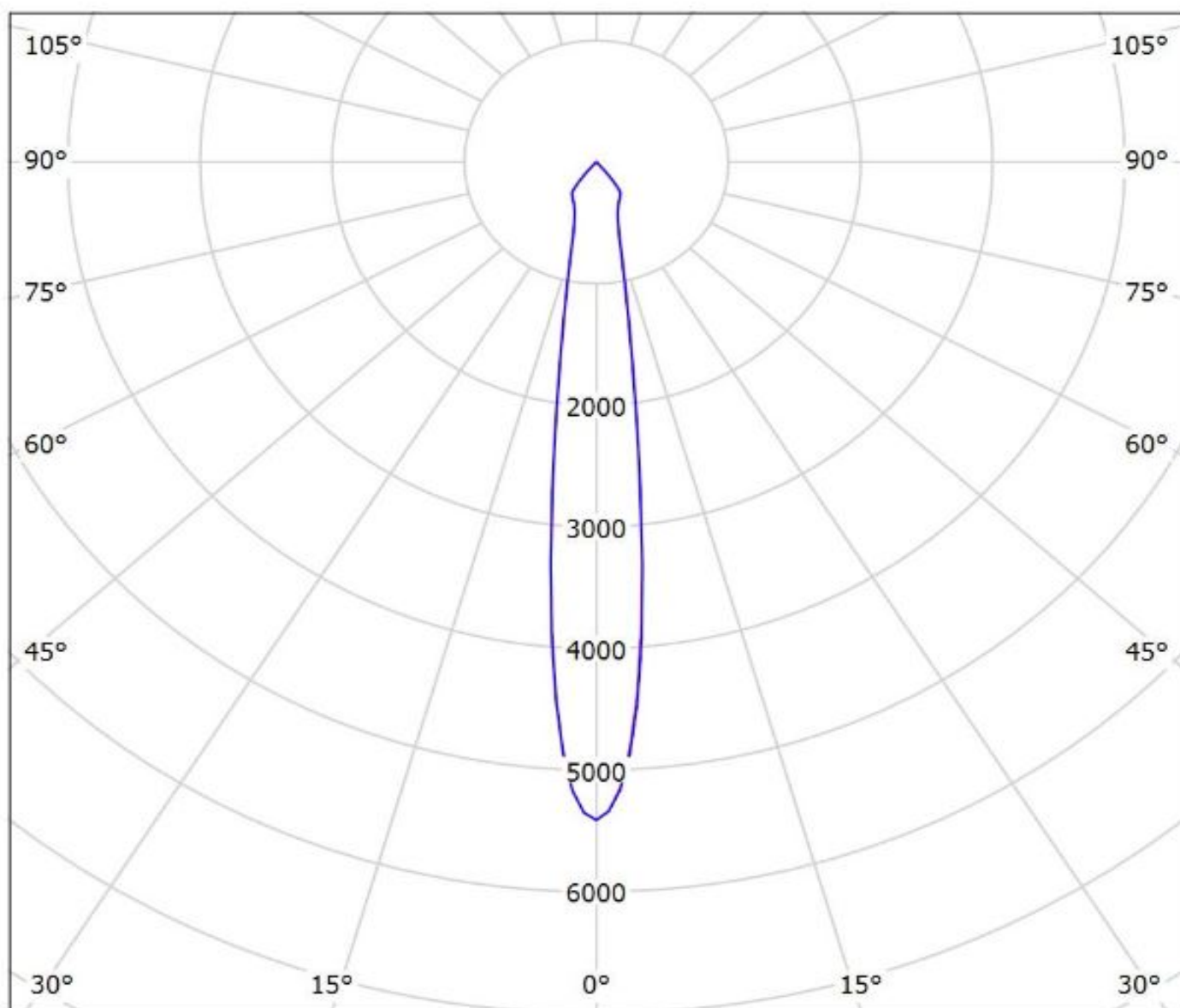

cd/klm

— C0 - C180

— C90 - C270

$\eta = 90\%$

Luminaire: Ledil F14532\_ANGELETTE-S\_(S19+TE)  
Lamps: 1 x Osram\_Soleriq\_S19\_(GW\_KAHJB1.EM)\_+2213407-2+2213194-1\_1546.1lm@250mA\_CCT=3000K\_P=11.021W\_I=0.25A

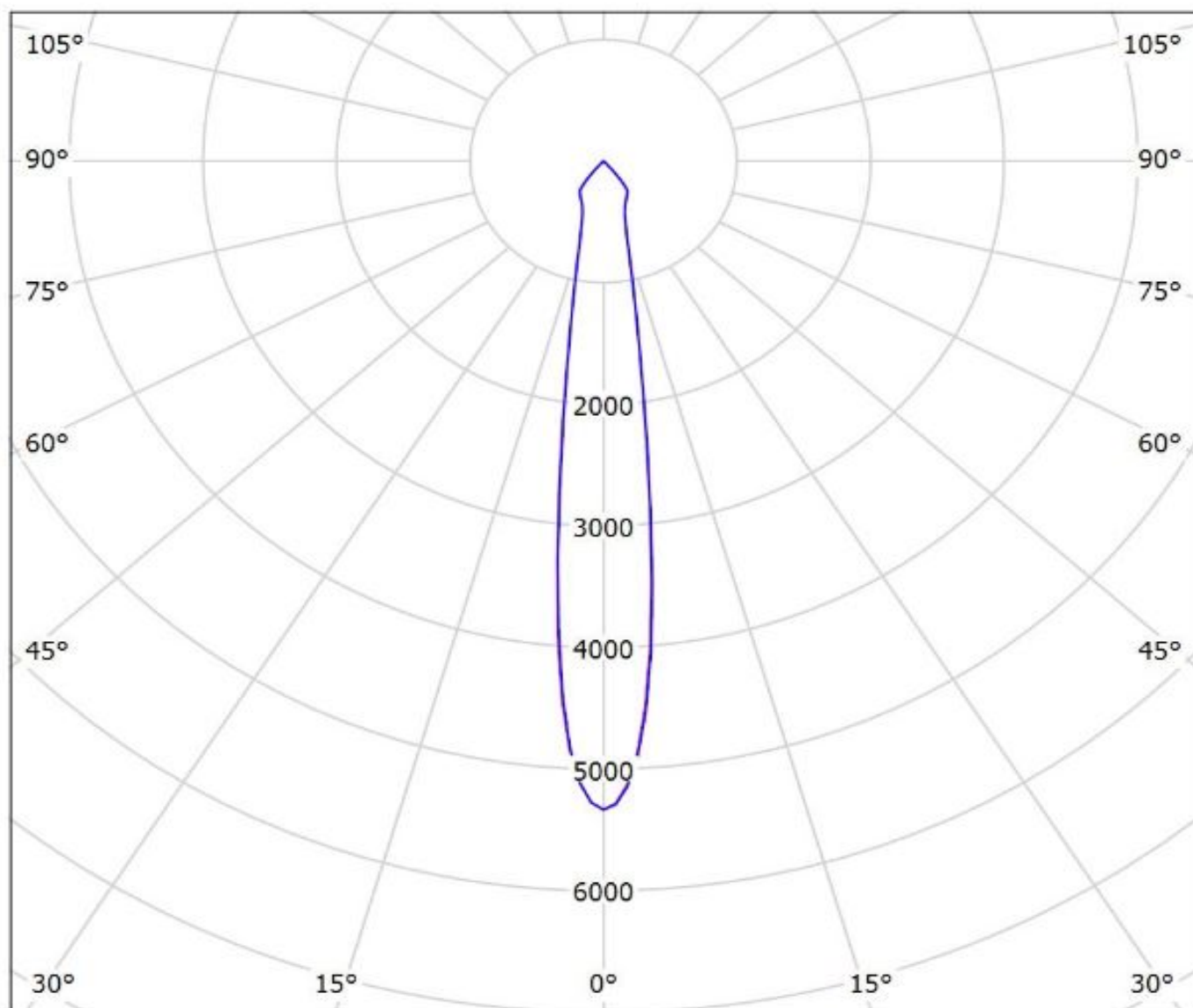

cd/klm  
— C0 - C180 — C90 - C270

$\eta = 90\%$

Luminaire: Ledil F14532\_ANGELETTE-S\_(S13\_Gen2+TE)

Lamps: 1 x Soleriq\_S13\_Gen2+\_2213254-2+\_2213194-1\_1309.23lm@250mA\_P=8.7840W\_I=0.250A

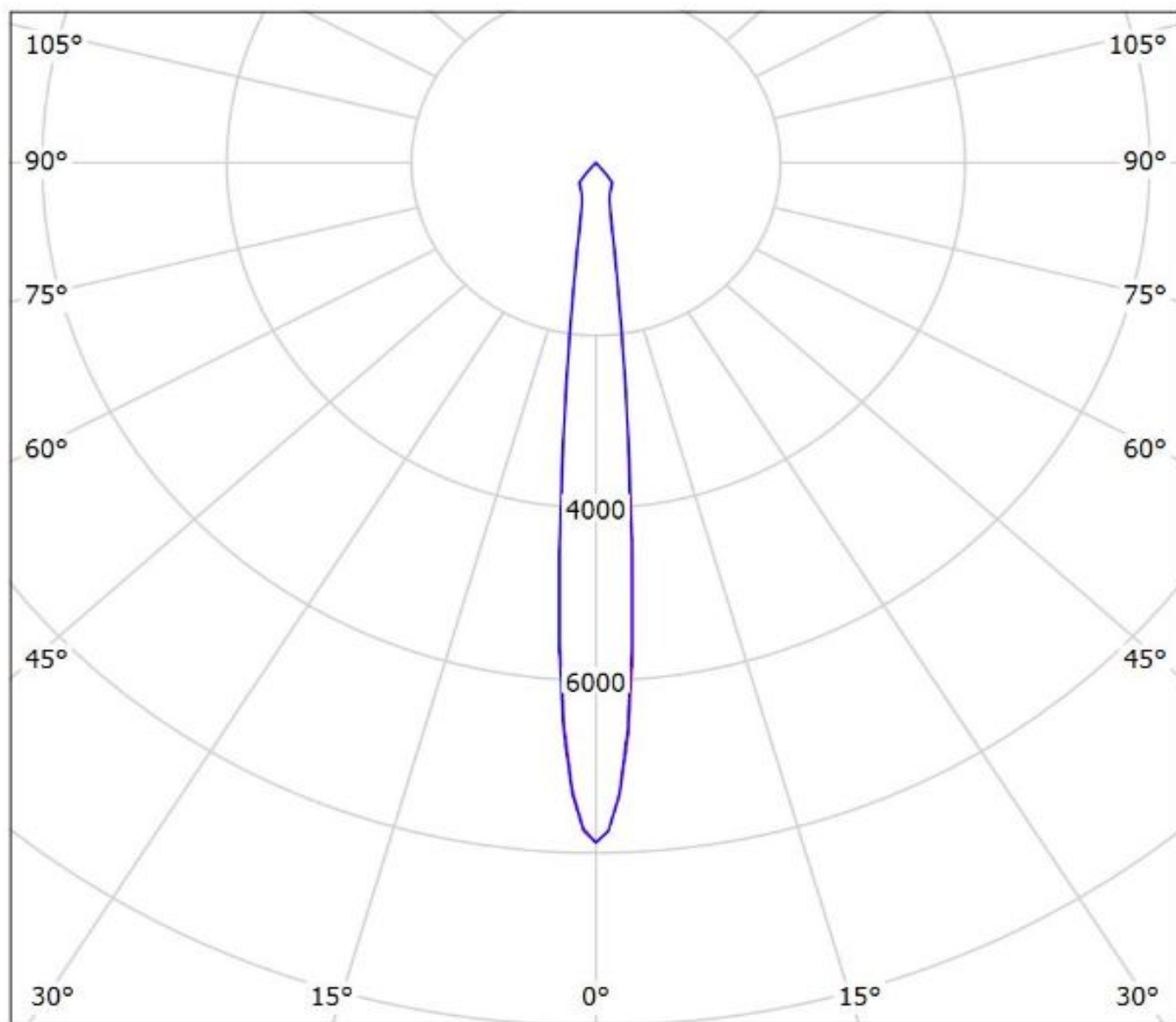

cd/klm

— C0 - C180

— C90 - C270

$\eta = 89\%$

Luminaire: Ledil F14532\_ANGELETTE-S\_(S13\_Gen2+IDEAL)

Lamps: 1 x Soleriq\_S13\_Gen2+\_50-2103CT+\_50-2100AN\_1327.38lm@250mA\_P=8.7850W\_I=0.250A

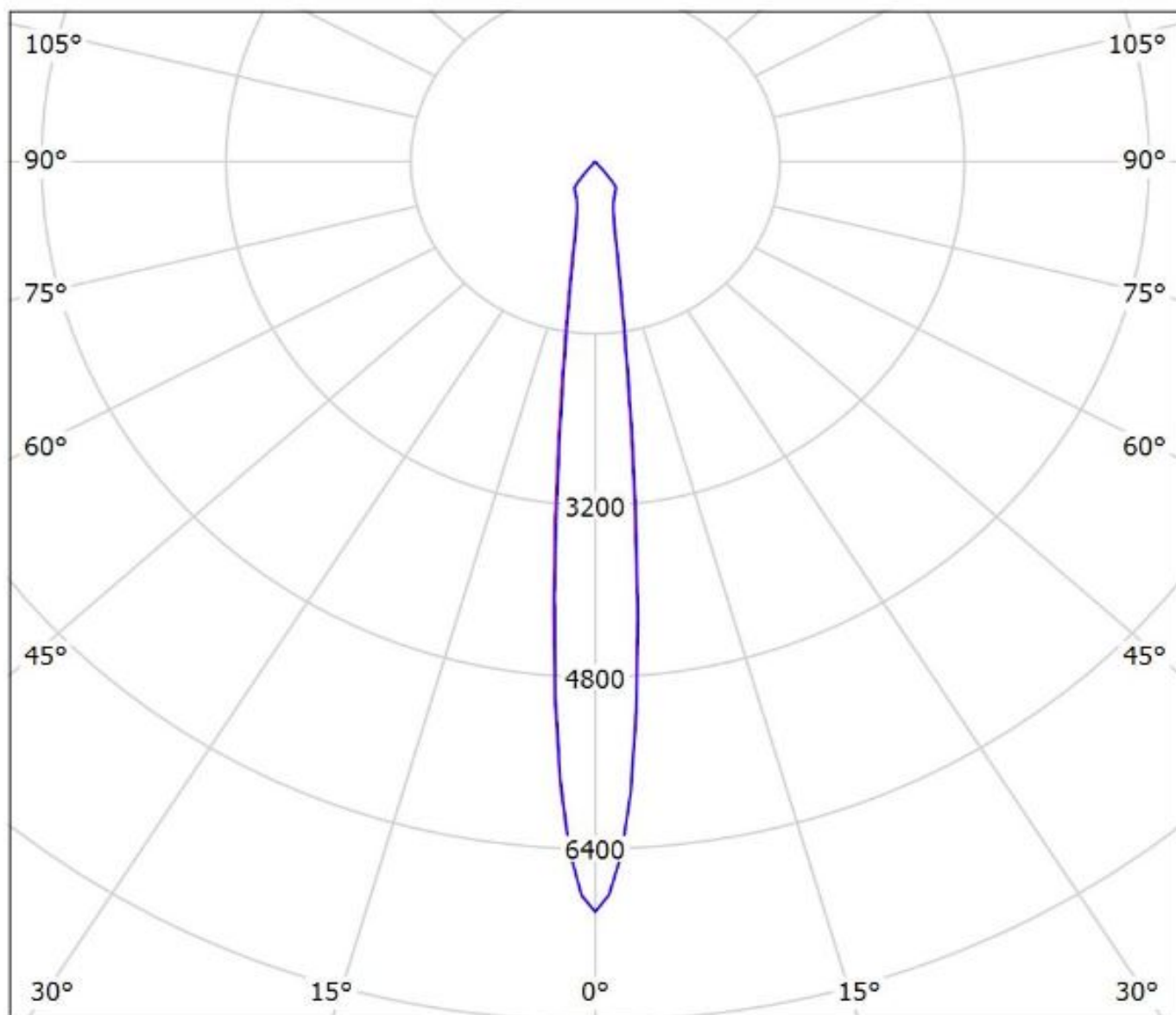

cd/klm

— C0 - C180 — C90 - C270

$\eta = 89\%$

Luminaire: Ledil F14619\_ANGELETTE-S-PLAIN\_(S13\_Gen2+IDEAL)

Lamps: 1 x Soleriq\_S13\_Gen2+\_50-2103CT+\_50-2100AN\_1327.38lm@250mA\_P=8.7850W\_I=0.250A

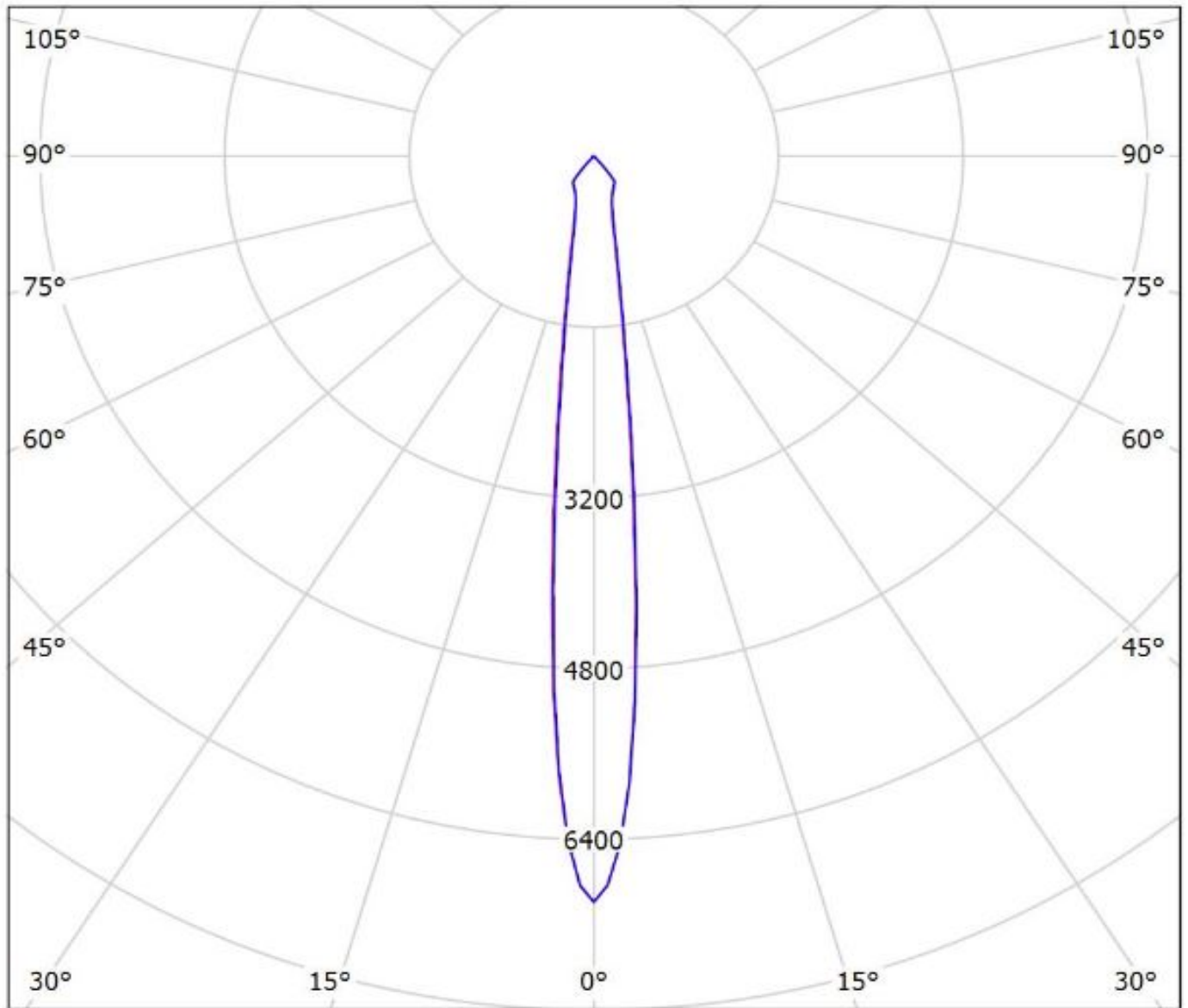

cd/klm

— C0 - C180

— C90 - C270

$\eta = 89\%$

Luminaire: Ledil F14532\_ANGELETTE-S\_(SLM\_G5\_LES\_15\_+TE)

Lamps: 1 x Philips\_SLM\_G5\_LES\_15\_+TE\_2213194-1\_1277.72lm@250mA\_P=8.208W\_I=0.25A

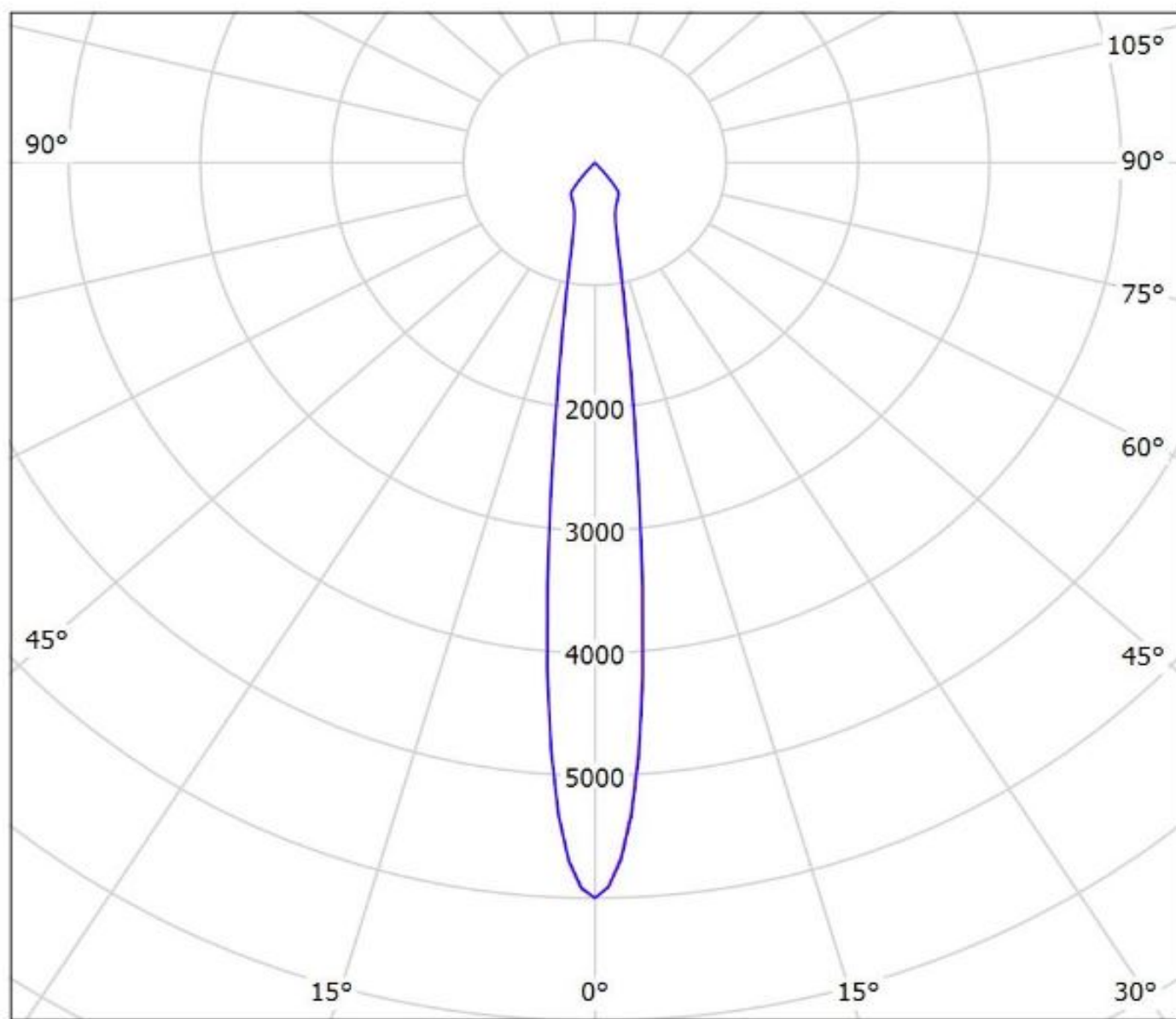

cd/klm

— C0 - C180

— C90 - C270

$\eta = 89\%$



Luminaire: Ledil F14532\_ANGELETTE-S\_(LC040C+TE)

Lamps: 1 x Samsung\_LC040C+\_2213382-2+\_2213194-1\_1194.16lm@250mA\_CCT=4000K\_P=8.137W

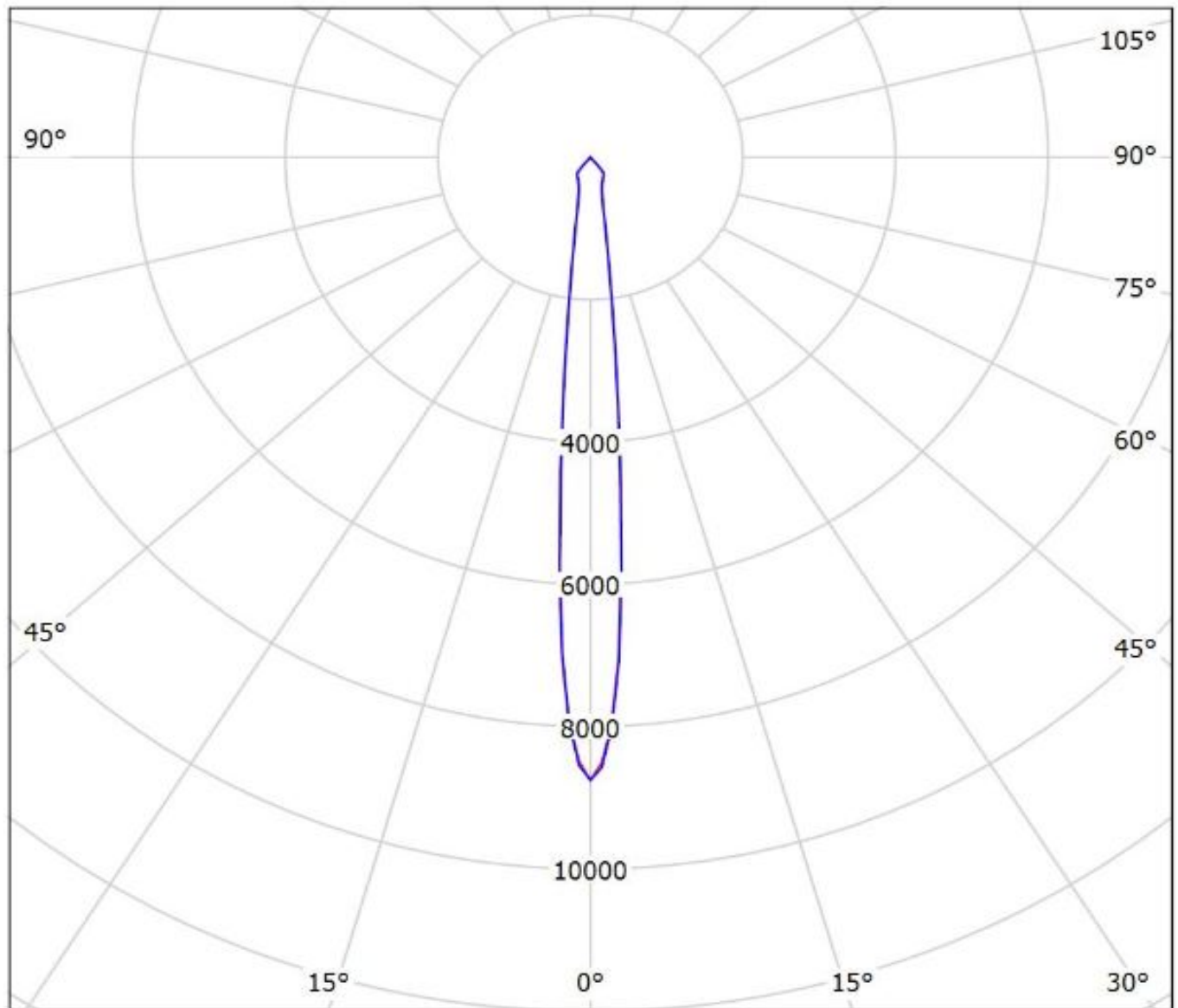

cd/klm  
— C0 - C180 — C90 - C270

$\eta = 90\%$

Luminaire: Ledil F14532\_ ANGELETTE-S\_(MJT\_30W\_Les14,5)\_TE

Lamps: 1 x Seoul\_MJT\_30W\_Les14,5mm\_(SAWx1566A)\_+TE\_2213254-2\_+\_TE\_2213194-1\_1328.6lm@250mA\_P=8.24025W\_I=0.25A

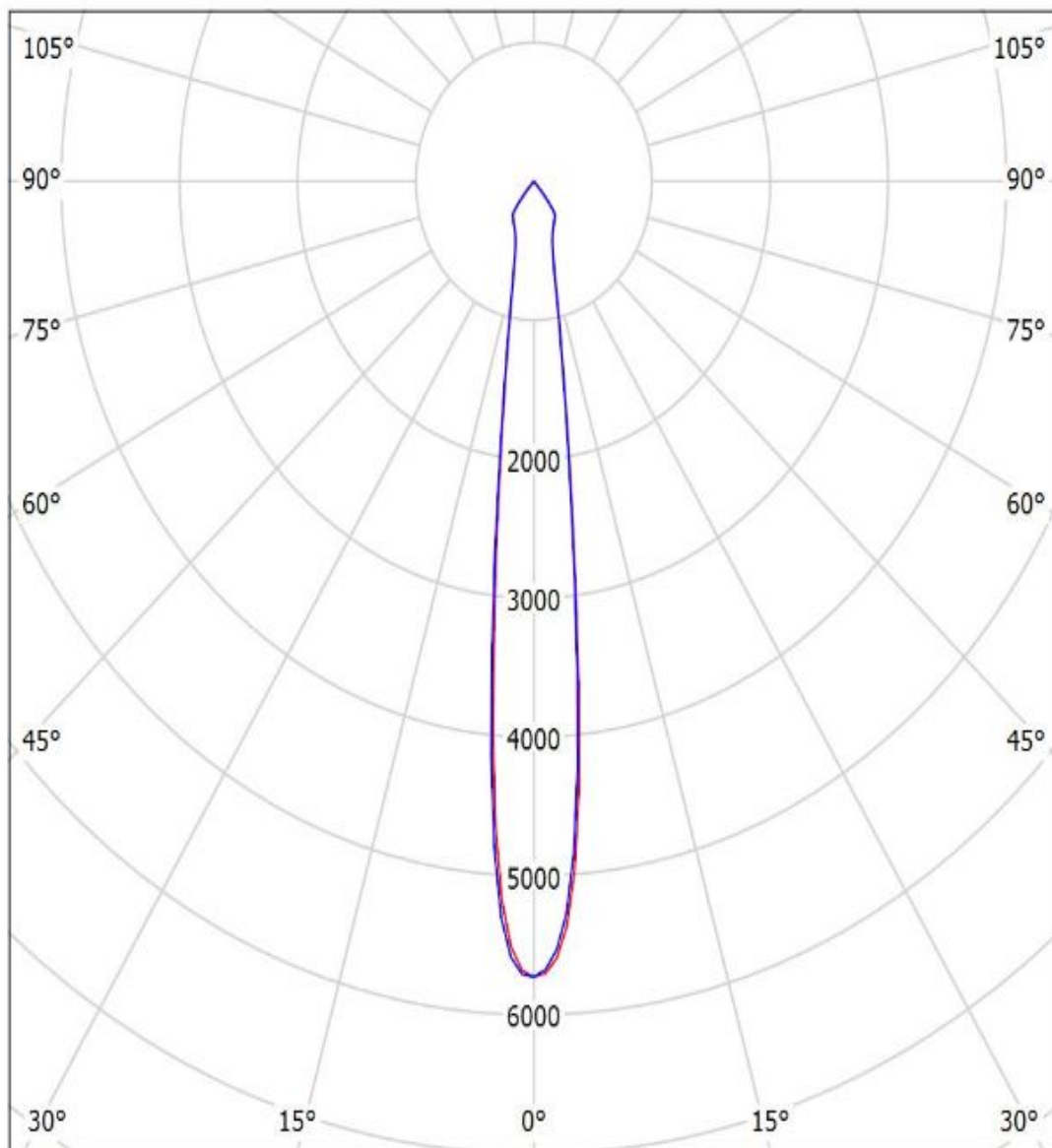

$\eta = 89\%$

cd/klm

— C0 - C180 — C90 - C270

Luminaire: Ledil Oy F14532\_ANGELETTE-S\_(SLE\_G6\_LES15)\_(2213254-2+\_2213194-1)\_SIMULATED  
Lamps: 1 x Tridonic SLE G6 LES15 + Tyco Electronics 2213254-2 + TE 2213194-1 Optic clip

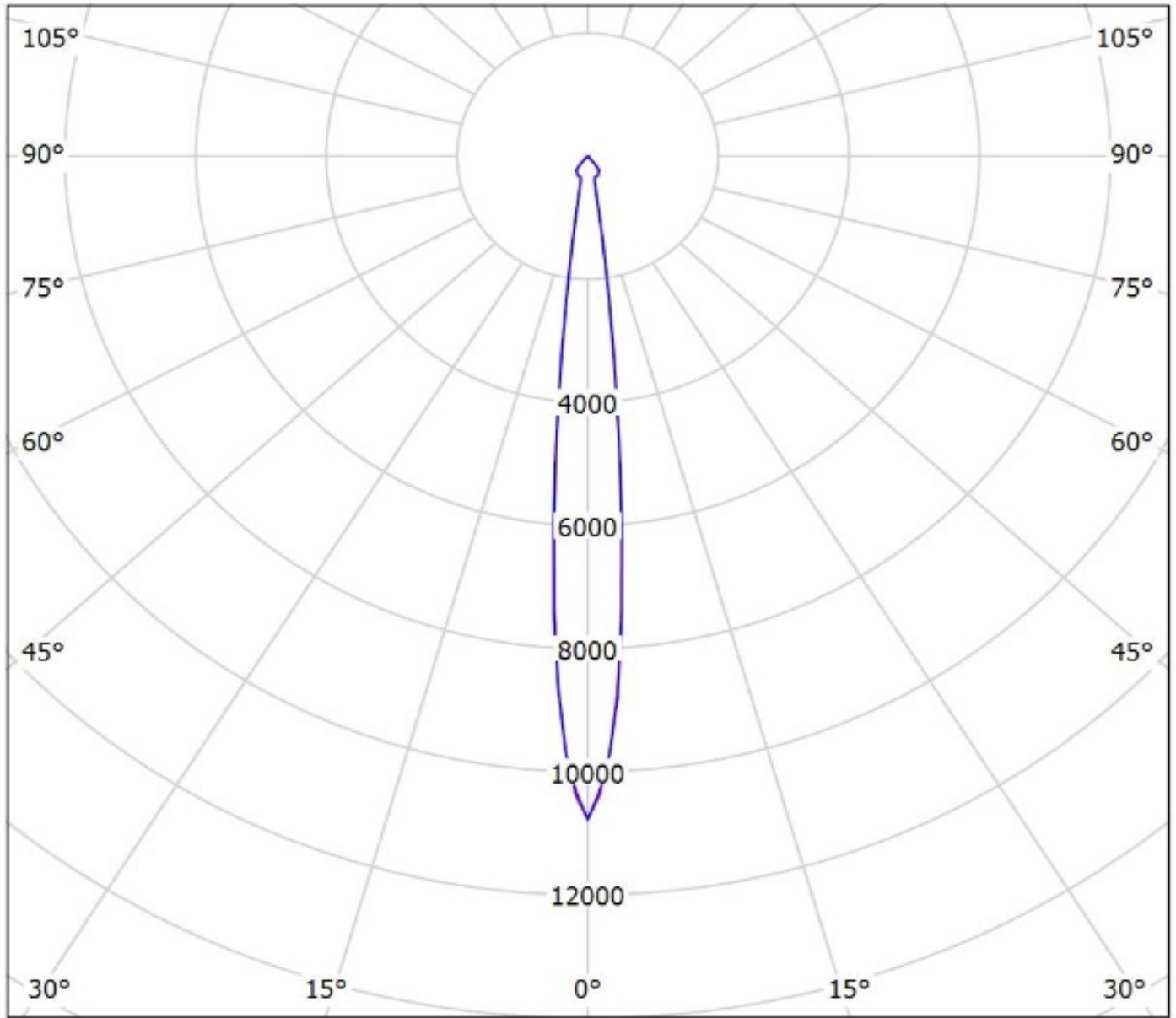

cd/klm

— C0 - C180 — C90 - C270

$\eta = 90\%$

Luminaire: Ledil Oy F14532\_ANGELETTE-S+\_TE\_2213254-2+\_TE\_Z50\_Type1\_TRIDONIC\_SLE\_G6\_LES17\_SIMULATED  
Lamps: 1 x TRIDONIC SLE G6 LES17

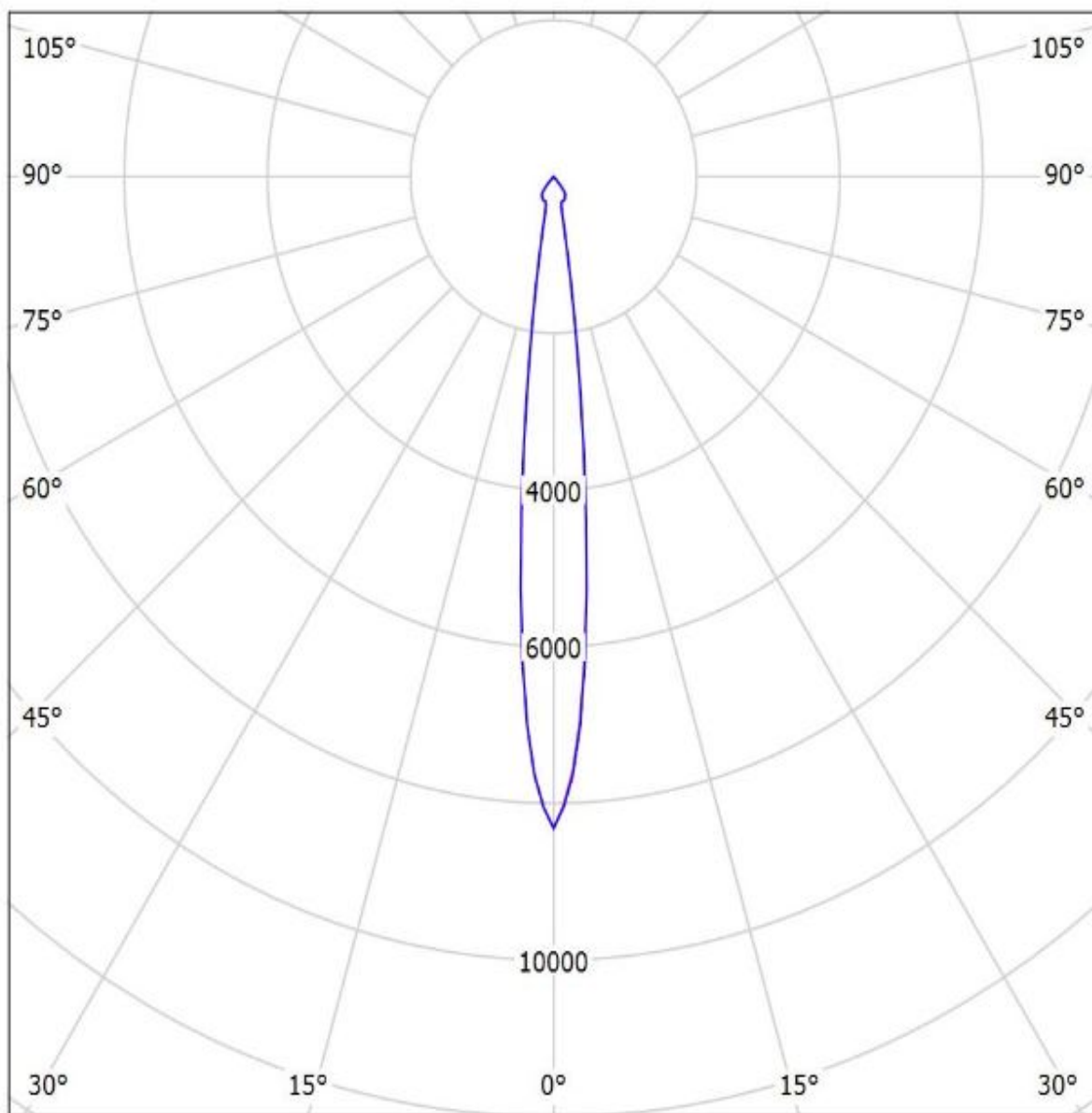

cd/klm

— C0 - C180 — C90 - C270

$\eta = 87\%$

Luminaire: Ledil F14532\_ANGELETTE-S\_(WU-M-484+TE)

Lamps: 1 x Vossloh\_Schwabe\_WU-M-484-830\_681.21lm@250mA\_P=5.6195W\_I=0.25A

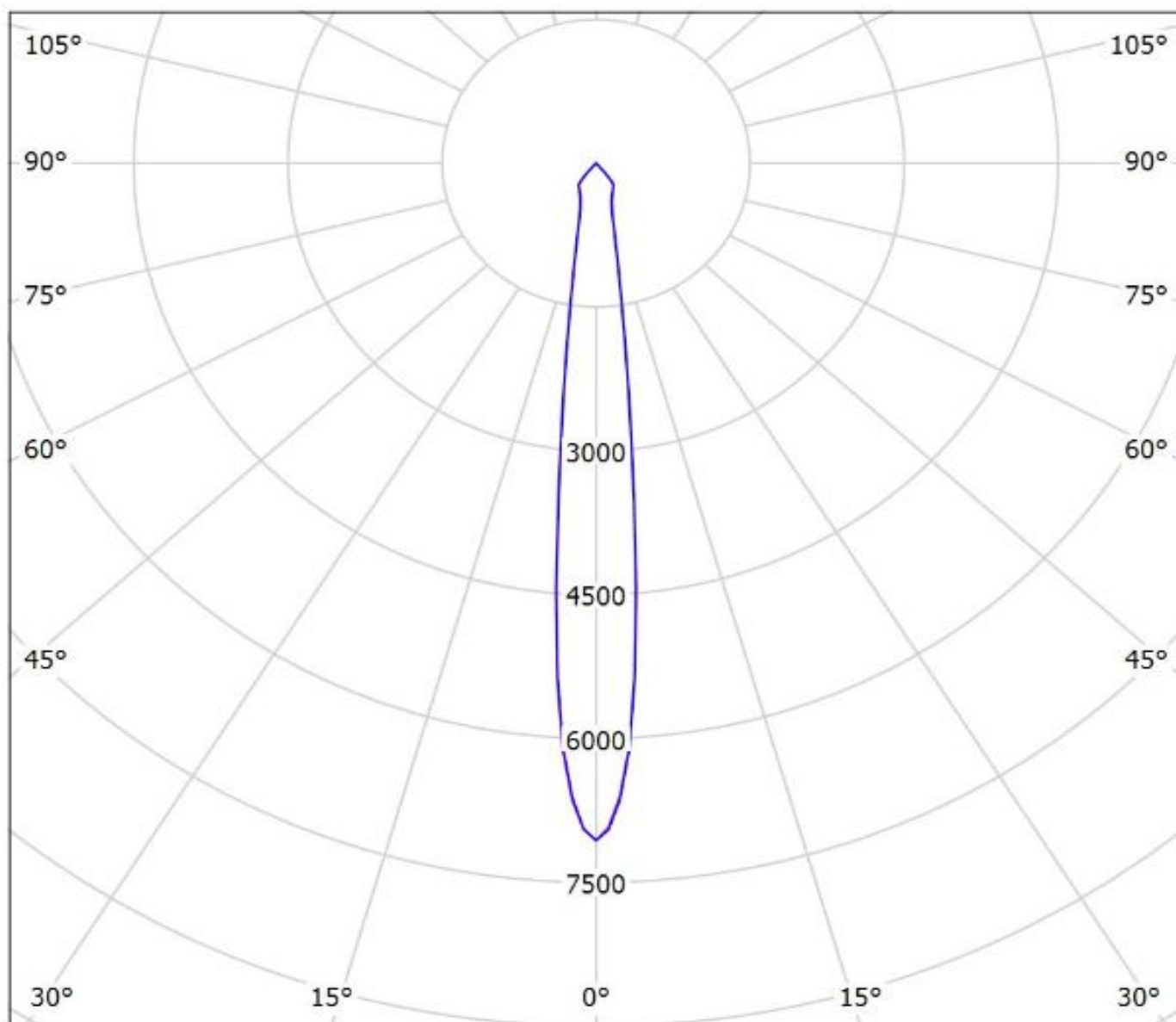

cd/klm

— C0 - C180

— C90 - C270

$\eta = 89\%$

**NOTE: The typical divergence will be changed by different color, chip size and chip position tolerance. The typical total divergence is the full angle measured where the luminous intensity is half of the peak value.**

### **GENERAL INFORMATION**

- Product series especially designed & optimized for series of LEDs.
- Special care taken to make light distribution as uniform as possible.

Note! Due to use of high power COB's with this product, special attention to proper thermal design is highly recommended. LEDiL has no liability for direct, indirect or consecutive damages arising from the LEDiL products being used outside of the recommended temperature range.