

3950X SERIES  
3.50mm HEADERS

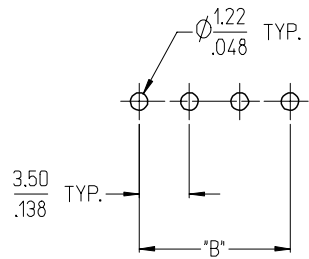

3952X & 3954X SERIES  
5.00mm HEADERS  
5.00mm 10 AMP FIXED

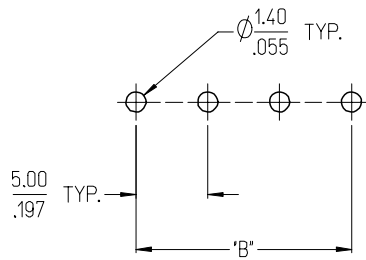

3953X SERIES  
5.08mm HEADERS

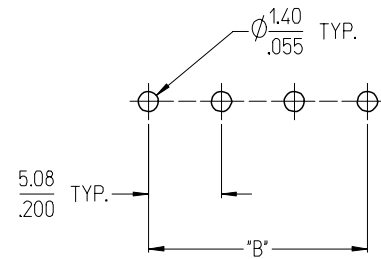

3951X SERIES  
3.81mm HEADERS

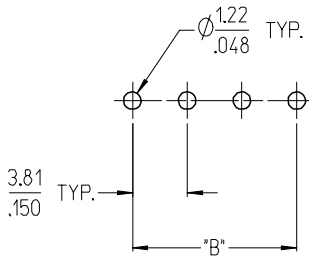

3954X SERIES  
5.00mm 15 AMP FIXED

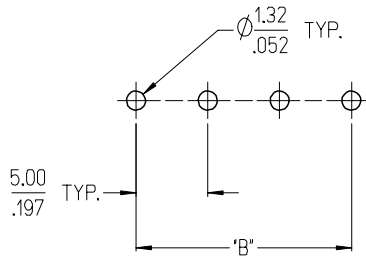

3954X SERIES  
5.08mm 15 AMP FIXED

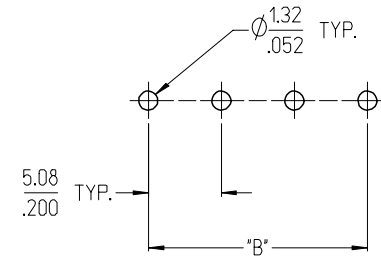

NOTES:

- REFER TO INDIVIDUAL PRODUCT SALES DRAWINGS FOR "B" DIMENSION.
- DOES NOT APPLY TO DUAL LEVEL HEADERS, SERIES 39528 AND 39538.
- TYP. = TYPICAL.

INITIAL RELEASE  
EC NO: ETC2007-0096  
DRW: CLYORK 2006/10/02  
CHKD: JMACNEIL 2006/10/04  
APPR: JMACNEIL 2006/10/04

QUALITY SYMBOLS  
 = 0  
 = 0

GENERAL TOLERANCES (UNLESS SPECIFIED)	
	MM/IN
4 PLACES	± --- ± ---
3 PLACES	± --- ± .005
2 PLACES	± 0.13 ± .01
1 PLACE	± 0.3 ± ---
ANGULAR ± 2 °	

DIMENSION STYLE	
MM/IN	
DRAWN BY	DATE
C. YORK	2006/08/25
CHECKED BY	DATE
J. MACNEIL	2006/08/25
APPROVED BY	DATE
J. MACNEIL	2006/08/25
MATERIAL NO.	
--	

SCALE	DESIGN UNITS	THIRD ANGLE PROJECTION
3:1	INCH	
TITLE		
RECOMMENDED PCB LAYOUT FOR ESE TERMINAL BLOCKS		
MOLEX INCORPORATED		
DOCUMENT NO.	SHEET NO.	
SD-39501-002	1 OF 1	
SIZE B		
THIS DRAWING CONTAINS INFORMATION THAT IS PROPRIETARY TO MOLEX INCORPORATED AND SHOULD NOT BE USED WITHOUT WRITTEN PERMISSION		

10 9 8 7 6 5 4 3 2 1

F  
E  
D  
C  
B  
A

F  
E  
D  
C  
B  
A

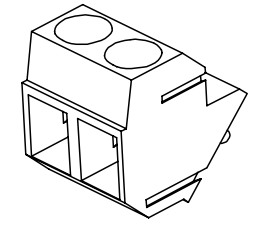
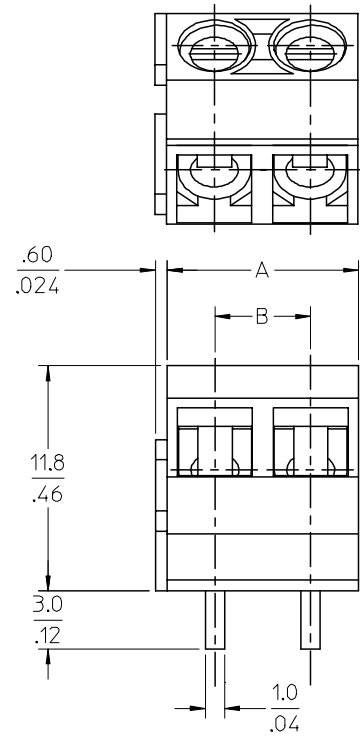
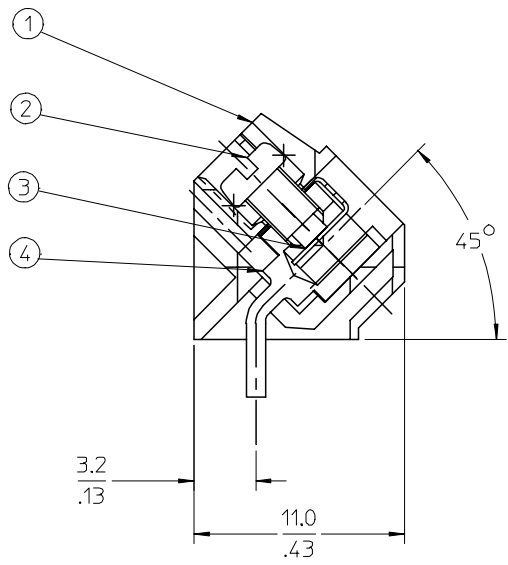
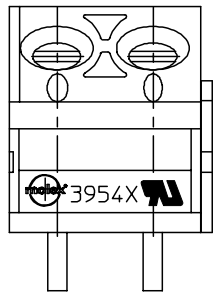

**SPECIFICATIONS:**

1. Material:
  - (1). Body: PA66
  - (2). Screw: Steel
  - (3). Wire Protector: QSn
  - (4). Terminal: Brass
2. Wire range: 24 - 14AWG.
3. Electrical rating: 300V, 10A.
4. MAX TORQUE: 3 in-lbs.
5. Wire strip length: 5.00mm.
6. Insulation resistance: DC500V, 500M.
7. Operating temperature: -40C to +105C.
8. A = N x P.
9. B = (N - 1) x P
10. P = (Pitch) = 5.00MM (.197").
11. N = Number of positions available 2 through 24.

RELEASE  
EC NO: NEC2006-0310  
DRWNL: LROTHAUS 2006/01/09  
CHKD: CYORK 2006/01/09  
APPR: JPAMLIK 2006/01/10

REV	DESCRIPTION
A	

QUALITY SYMBOLS	
	=0
	=0
GENERAL TOLERANCES (UNLESS SPECIFIED)	
	mm
4 PLACES	± ---
3 PLACES	± 0.038
2 PLACES	± 0.13
1 PLACE	± 0.3
ANGULAR ± 2 °	
DRAFT WHERE APPLICABLE MUST REMAIN WITHIN DIMENSIONS	

DIMENSION STYLE	
MM/IN	
DRAWN BY	DATE
LROTHAUS	10/7/05
CHECKED BY	DATE
C. YORK	01/06/06
APPROVED BY	DATE
MATERIAL NO.	
See Chart	

SCALE	DESIGN UNITS	THIRD ANGLE PROJECTION
4:1	INCH	
TITLE		
5.0MM, EURO TERM. BLOCK PC MOUNT, 45 DEGREE		
APPROVED BY		
MOLEX INCORPORATED		
MATERIAL NO.	DOCUMENT NO.	SHEET NO.
See Chart	SD-39543-001	1 OF 1
SIZE B		
THIS DRAWING CONTAINS INFORMATION THAT IS PROPRIETARY TO MOLEX INCORPORATED AND SHOULD NOT BE USED WITHOUT WRITTEN PERMISSION		

9 8 7 6 5 4 3 2 1

Description	Circuit size	Material Numbers Molded to Length									Material Numbers Stackable						Dimensional Information	
		Black			Green			Black			Green			Dim. A	Dim B			
		100% Tin			100% Tin			100% Tin			100% Tin							
		Printing Options			Printing Options			Printing Options			Printing Options							
None	10A	11A	None	10A	11A	None	10A	11A	None	10A	11A	None	10A	11A	mm	inch		
5.0mm, Euro Block, PC Mount, 45 Deg	2	395430202	395431202	395432202	395930202	395931202	395932202	395430502	395431502	395432502	395930502	395931502	395932502	10.00	0.394	5.00	0.197	
5.0mm, Euro Block, PC Mount, 45 Deg	3	395430203	395431203	395432203	395930203	395931203	395932203	395430503	395431503	395432503	395930503	395931503	395932503	15.00	0.591	10.00	0.394	
5.0mm, Euro Block, PC Mount, 45 Deg	4	395430204	395431204	395432204	395930204	395931204	395932204	N/A	N/A	N/A	N/A	N/A	N/A	20.00	0.787	15.00	0.591	
5.0mm, Euro Block, PC Mount, 45 Deg	5	395430205	395431205	395432205	395930205	395931205	395932205	N/A	N/A	N/A	N/A	N/A	N/A	25.00	0.984	20.00	0.787	
5.0mm, Euro Block, PC Mount, 45 Deg	6	395430206	395431206	395432206	395930206	395931206	395932206	N/A	N/A	N/A	N/A	N/A	N/A	30.00	1.181	25.00	0.984	
5.0mm, Euro Block, PC Mount, 45 Deg	7	395430207	395431207	395432207	395930207	395931207	395932207	N/A	N/A	N/A	N/A	N/A	N/A	35.00	1.378	30.00	1.181	
5.0mm, Euro Block, PC Mount, 45 Deg	8	395430208	395431208	395432208	395930208	395931208	395932208	N/A	N/A	N/A	N/A	N/A	N/A	40.00	1.575	35.00	1.378	
5.0mm, Euro Block, PC Mount, 45 Deg	9	395430209	395431209	395432209	395930209	395931209	395932209	N/A	N/A	N/A	N/A	N/A	N/A	45.00	1.772	40.00	1.575	
5.0mm, Euro Block, PC Mount, 45 Deg	10	395430210	395431210	395432210	395930210	395931210	395932210	N/A	N/A	N/A	N/A	N/A	N/A	50.00	1.969	45.00	1.772	
5.0mm, Euro Block, PC Mount, 45 Deg	11	395430211	395431211	395432211	395930211	395931211	395932211	N/A	N/A	N/A	N/A	N/A	N/A	55.00	2.165	50.00	1.969	
5.0mm, Euro Block, PC Mount, 45 Deg	12	395430212	395431212	395432212	395930212	395931212	395932212	N/A	N/A	N/A	N/A	N/A	N/A	60.00	2.362	55.00	2.165	
5.0mm, Euro Block, PC Mount, 45 Deg	13	395430213	395431213	395432213	395930213	395931213	395932213	N/A	N/A	N/A	N/A	N/A	N/A	65.00	2.559	60.00	2.362	
5.0mm, Euro Block, PC Mount, 45 Deg	14	395430214	395431214	395432214	395930214	395931214	395932214	N/A	N/A	N/A	N/A	N/A	N/A	70.00	2.756	65.00	2.559	
5.0mm, Euro Block, PC Mount, 45 Deg	15	395430215	395431215	395432215	395930215	395931215	395932215	N/A	N/A	N/A	N/A	N/A	N/A	75.00	2.953	70.00	2.756	
5.0mm, Euro Block, PC Mount, 45 Deg	16	395430216	395431216	395432216	395930216	395931216	395932216	N/A	N/A	N/A	N/A	N/A	N/A	80.00	3.150	75.00	2.953	
5.0mm, Euro Block, PC Mount, 45 Deg	17	395430217	395431217	395432217	395930217	395931217	395932217	N/A	N/A	N/A	N/A	N/A	N/A	85.00	3.346	80.00	3.150	
5.0mm, Euro Block, PC Mount, 45 Deg	18	395430218	395431218	395432218	395930218	395931218	395932218	N/A	N/A	N/A	N/A	N/A	N/A	90.00	3.543	85.00	3.346	
5.0mm, Euro Block, PC Mount, 45 Deg	19	395430219	395431219	395432219	395930219	395931219	395932219	N/A	N/A	N/A	N/A	N/A	N/A	95.00	3.740	90.00	3.543	
5.0mm, Euro Block, PC Mount, 45 Deg	20	395430220	395431220	395432220	395930220	395931220	395932220	N/A	N/A	N/A	N/A	N/A	N/A	100.00	3.937	95.00	3.740	
5.0mm, Euro Block, PC Mount, 45 Deg	21	395430221	395431221	395432221	395930221	395931221	395932221	N/A	N/A	N/A	N/A	N/A	N/A	105.00	4.134	100.00	3.937	
5.0mm, Euro Block, PC Mount, 45 Deg	22	395430222	395431222	395432222	395930222	395931222	395932222	N/A	N/A	N/A	N/A	N/A	N/A	110.00	4.331	105.00	4.134	
5.0mm, Euro Block, PC Mount, 45 Deg	23	395430223	395431223	395432223	395930223	395931223	395932223	N/A	N/A	N/A	N/A	N/A	N/A	115.00	4.528	110.00	4.331	
5.0mm, Euro Block, PC Mount, 45 Deg	24	395430224	395431224	395432224	395930224	395931224	395932224	N/A	N/A	N/A	N/A	N/A	N/A	120.00	4.724	115.00	4.528	

SEE SHEET 1 EC NO: NEC2006-0310 DRWN: L.ROTHAUS 2006/01/09 CHKD: C.YORK 2006/01/09 APPR: J.P.MILLIK 2006/01/10	QUALITY SYMBOLS ▽=0 ▽=0	GENERAL TOLERANCES (UNLESS SPECIFIED)		DIMENSION STYLE		SCALE	DESIGN UNITS	THIRD ANGLE PROJECTION	
				MM/IN		4:1	INCH		
				DRAWN BY DATE		TITLE			
				CHECKED BY DATE		MOLEX INCORPORATED			
		APPROVED BY DATE		MATERIAL NO.		DOCUMENT NO.		SHEET NO.	
		ANGULAR ± 2 °		SEE CHART		SD-39543-001		2 OF 2	
		DRAFT WHERE APPLICABLE MUST REMAIN WITHIN DIMENSIONS		SIZE B		THIS DRAWING CONTAINS INFORMATION THAT IS PROPRIETARY TO MOLEX INCORPORATED AND SHOULD NOT BE USED WITHOUT WRITTEN PERMISSION			