

DETAILS

Product Number	C12360_STRADA-2X2-DNW
Family	Strada
Type	Lens array
Color	clear
Diameter	50x50 mm
Height	11,27 mm
Style	square
Optic Material	PMMA
Holder Material	
Fastening	screw, glue, pin
Status	production ready
ROHS Compliant	Yes
Date Updated	21/04/2016

OPTICAL PROPERTIES

LED	Viewing	Light	Effi-	cd/lm	Connector
	Angle	Beam	ciency		
XM-L	Asymmetric deg	Streetligh...	93 %	0.270	-
XP-G	Asymmetric deg	Streetligh...	93 %	0.440	-
XT-E	Asymmetric deg	Streetligh...	93 %	0.290	-
XT-E HVW	Asymmetric deg	Streetligh...	-	-	-
XQ-E	sim: Asymmetri	Streetligh...	sim: 93 %	-	-
XM-L2	asymmetric deg	Streetligh...	94 %	0.500	-
XP-G2	asymmetric deg	Streetligh...	94 %	0.600	-
XP-L	Asymmetric deg	Streetligh...	94 %	0.470	-
XP-L HI	asymmetric deg	Streetligh...	94 %	0.570	-
XP-G3	sim: Asym	Streetligh...	sim: 87 %	sim: 0.590	-
XP-L2	Asymmetric deg	Streetligh...	94 %	0.420	-
H35C0 (LEMWA33)	Asymmetric deg	Streetligh...	93 %	0.560	-
LUXEON Rebel ES	Asymmetric deg	Streetligh...	93 %	0.340	-
LUXEON T	Asymmetric deg	Streetligh...	93 %	0.600	-
LUXEON Z ES	Asymmetric deg	Streetligh...	94 %	0.620	-
LUXEON H50-2	sim: Asymmetri	Streetligh...	-	-	-
LUXEON Q	asymmetric deg	Streetligh...	94 %	0.600	-
LUXEON TX	asymmetric deg	Streetligh...	94 %	0.600	-
LUXEON MZ	Asymmetric deg	Streetligh...	94 %	0.440	-
NVSxx19B/NVSxx19C	sim: Asym	Streetligh...	sim: 94 %	sim: 0.621	-
NVSxE21A	asym deg	Streetligh...	94 %	0.310	-
NVSW3x9A	Asymmetric deg	Streetligh...	94 %	0.510	-
Oslon Square PC	Asymmetric deg	Streetligh...	93 %	0.500	-
Oslon Square Gen3	Asymmetric deg	Streetligh...	94 %	0.580	-
Duris S8	sim: Asymmetri	Streetligh...	sim: 92 %	sim: 0.400	-





PRODUCT DATASHEET

Strada series

last update 21/4/2016

OPTICAL PROPERTIES

LED	Viewing Angle	Light Beam	Efficiency	cd/lm	Connector
Duris P8	sim: Asymmetric	Streetlight	sim: 94 %	sim: 0.690	-
Fortimo FastFlex LED board 2x8 DA G4	asymmetric deg	Streetlight	94 %	0.650	-
LH351B	Asymmetric deg	Streetlight	94 %	0.550	-
LH351Z	asymmetric deg	Streetlight	94 %	0.610	-
LH351D	Asymmetric deg	Streetlight	94 %	0.450	-
Z5	Asymmetric deg	Streetlight	93 %	-	-
Acrich MJT 4040	Asymmetric deg	Streetlight	94 %	0.480	-
Z5M1/Z5M2	asymmetric deg	Streetlight	94 %	0.700	-
TL1L3	Asymmetric deg	Streetlight	94 %	0.430	-
TL1L4	Asymmetric deg	Streetlight	94 %	0.520	-
RLE G1 49x223mm 4000lm xxx EXC OT	Asymmetric deg	Streetlight	94 %	0.980	-
RLE G1 49x245mm 4000lm xxx EXC OT	Asymmetric deg	Streetlight	94 %	0.980	-
RLE G1 49x121mm 2000lm xxx EXC OT	Asymmetric deg	Streetlight	94 %	0.980	-
RLE G1 49x133mm 2000lm xxx EXC OT	Asymmetric deg	Streetlight	94 %	0.980	-

D

C

B

A

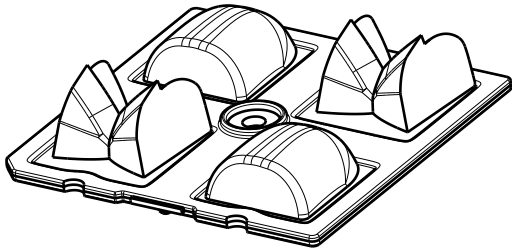

Isometric view

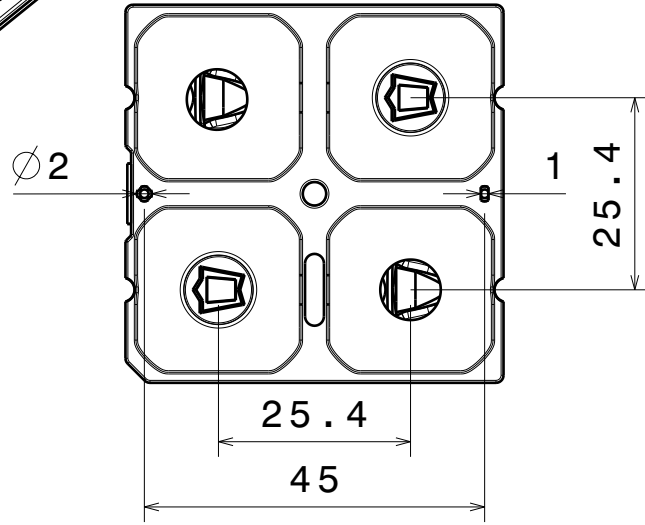

Bottom view

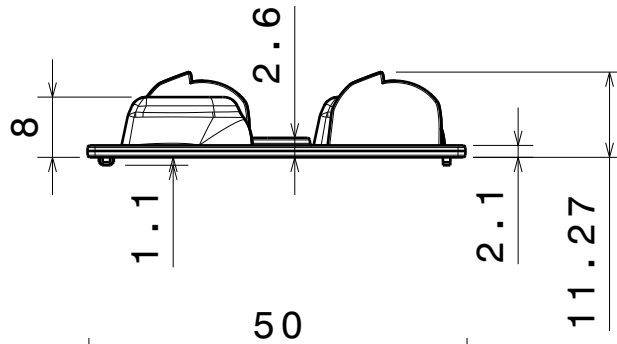

Front view

Injection gate

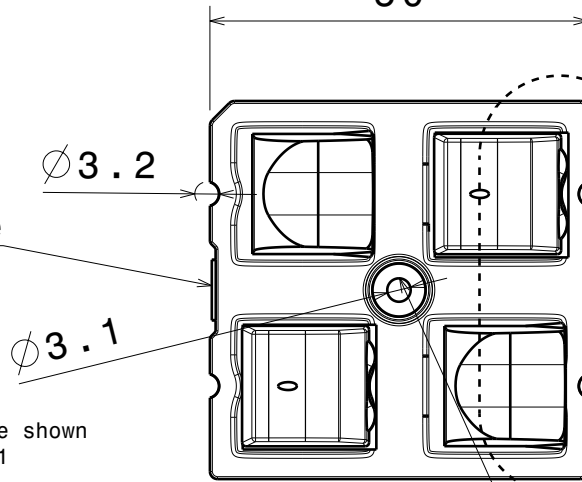

Top view

Beam direction (street side)

Screw hole

Tolerances if not otherwise shown
 According to DIN ISO 2768-1
 Linear measures:
 Up to 30mm class M, otherwise class C.
 According to DIN ISO 2768-2
 Form and position: class L

Material: PMMA

This drawing is our property.
 It can't be reproduced
 or communicated without
 our written agreement.



Ledil Oy
 Salorankatu 10
 FIN-24100 SALO
 Finland

DRAWING TITLE

Datasheet Strada-2x2-DNW

DRAWN BY
ah/mav

DATE
10.9.2012

CHECKED BY
ol

DATE
10.9.2012

SIZE
A4

DRAWING NUMBER
C12360

REV
4

DESIGNED BY
ol

DATE
18.10.2011

SCALE 1:1 WEIGHT (g)

SHEET 1/1

D

A

4

4

3

3

2

2

1

1

Luminaire: Ledil Oy C12360_Strada-2x2-DNW-XM-L Eff.93%
Lamps: 1 x Cree XM-L 400lm@250mA

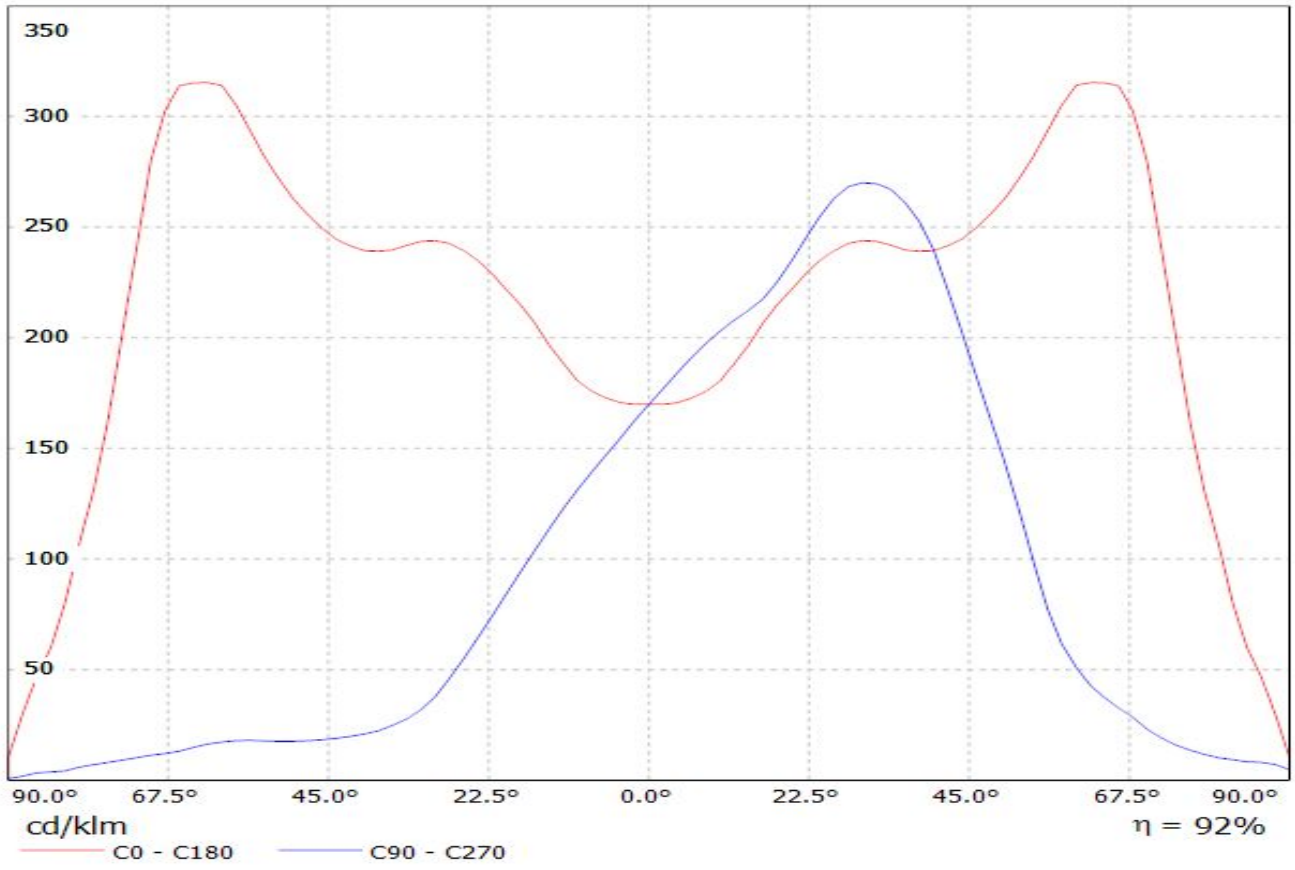

Luminaire: Ledil Oy C12360_STRADA-2X2-DNW (XP-G) Efficiency=94%
Lamps: 1 x Cree XP-G 282lm @ 250mA

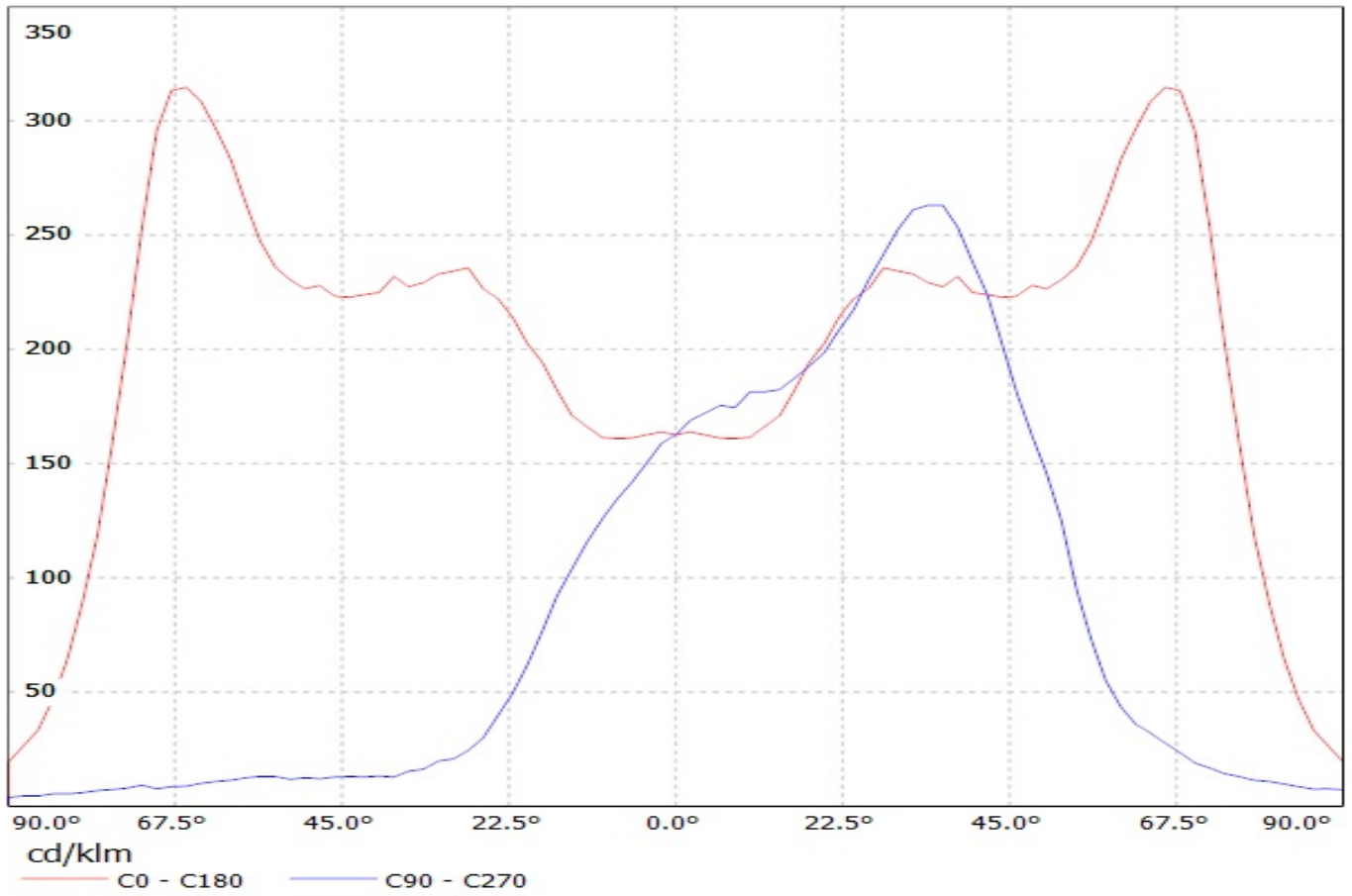

Luminaire: Ledil Oy C12360_Strada-2x2-DNWW (XT-E) Efficiency=93%
Lamps: 1 x Cree XT-E 250mA 409lm

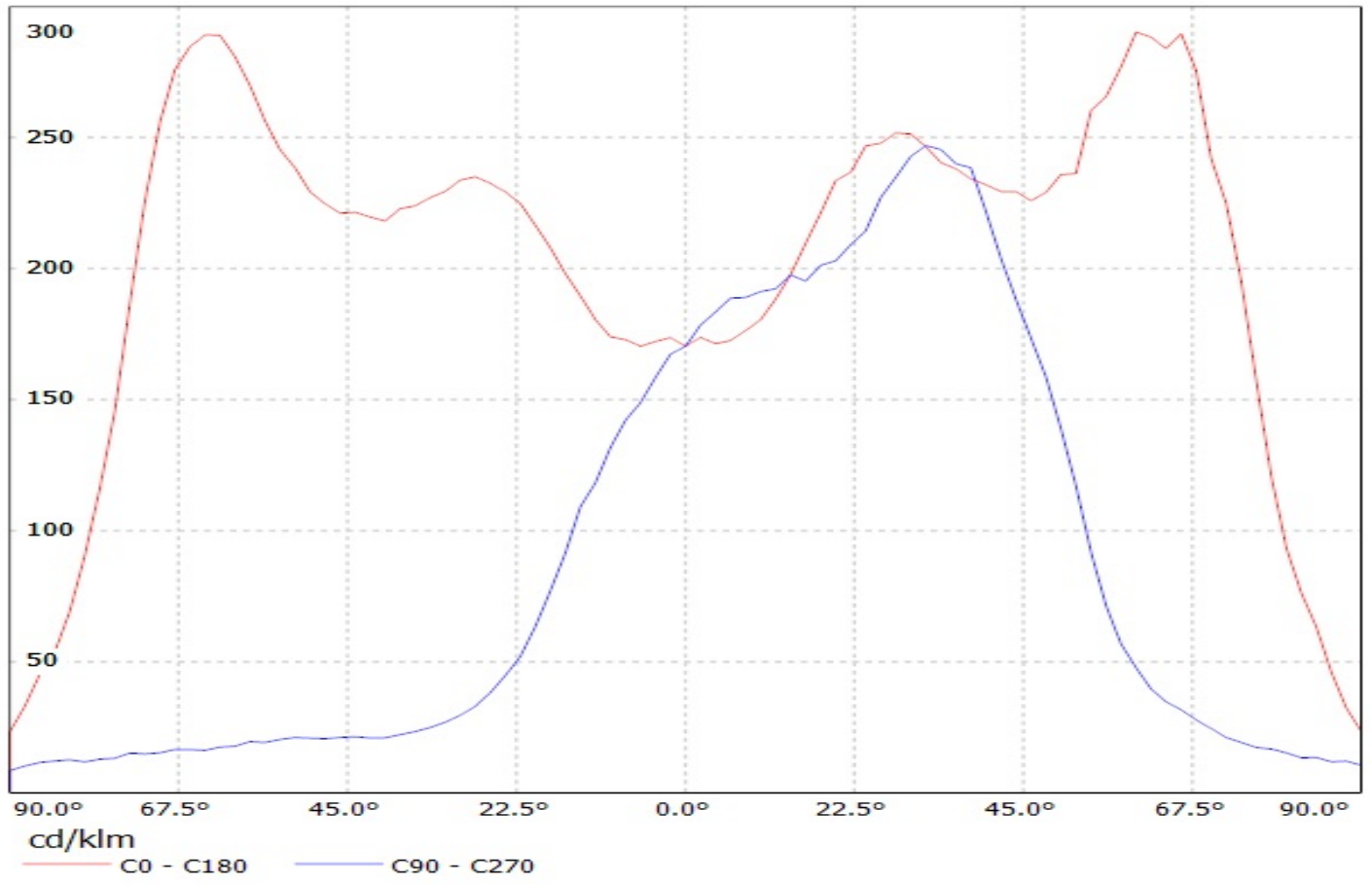

Luminaire: LEDil Oy C12360_STRADA-2X2-DNW_(XM-L2) Efficiency=94%
Lamps: 1 x Cree XM-L2 (XMLBWT-0-7B4-T30-0L-0001) 356lm @ 250mA CCT=3200K P=2.8W I=250mA

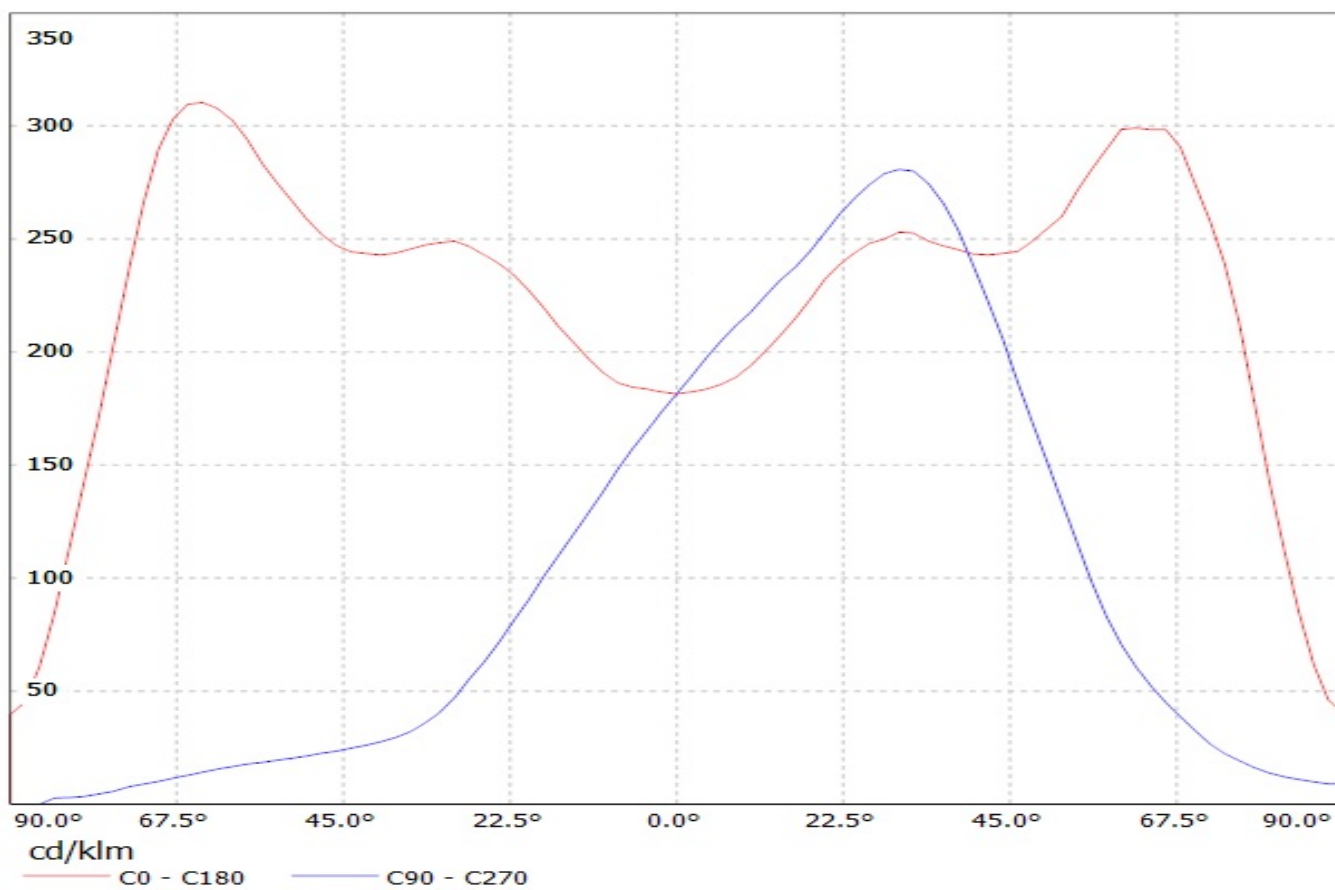

Luminaire: LEDil Oy C12360_STRADA-2X2-DNW_(XP-G2) Efficiency=94%
Lamps: 1 x CREE XP-G2 (XPGBWT-L1-000-00G51) 411lm @ 250mA CCT=7200K P=2.9W I=250mA

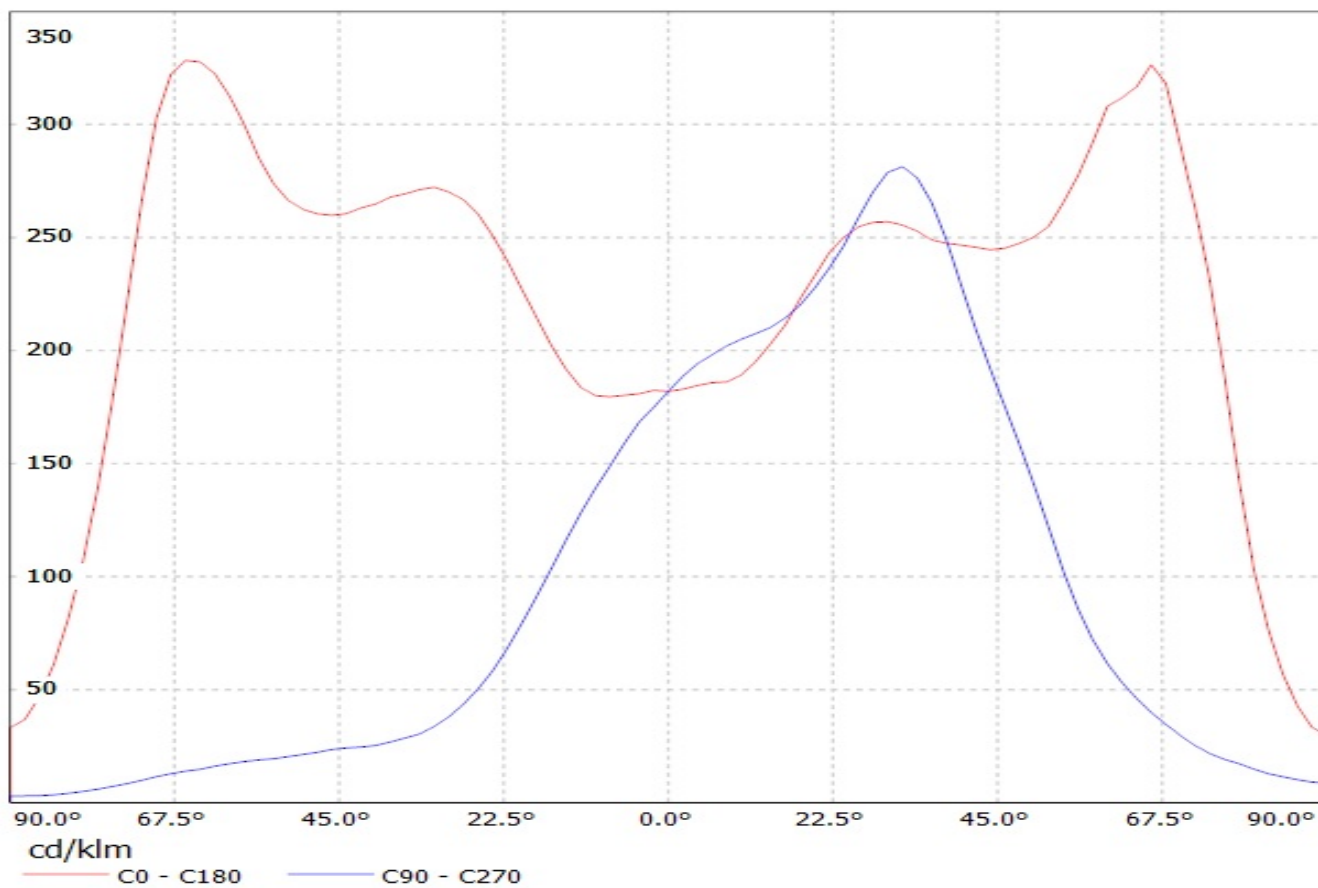

Luminaire: LEDiL Oy C12360_STRADA-2x2-DNW_(XP-L)

Lamps: 1 x CREE_XP-L_2x2_(XPLAWT-0-1B0-V40-00-0001)_510lm@250mA_CCT=7600K_P=2.79963W_I=249.9mA

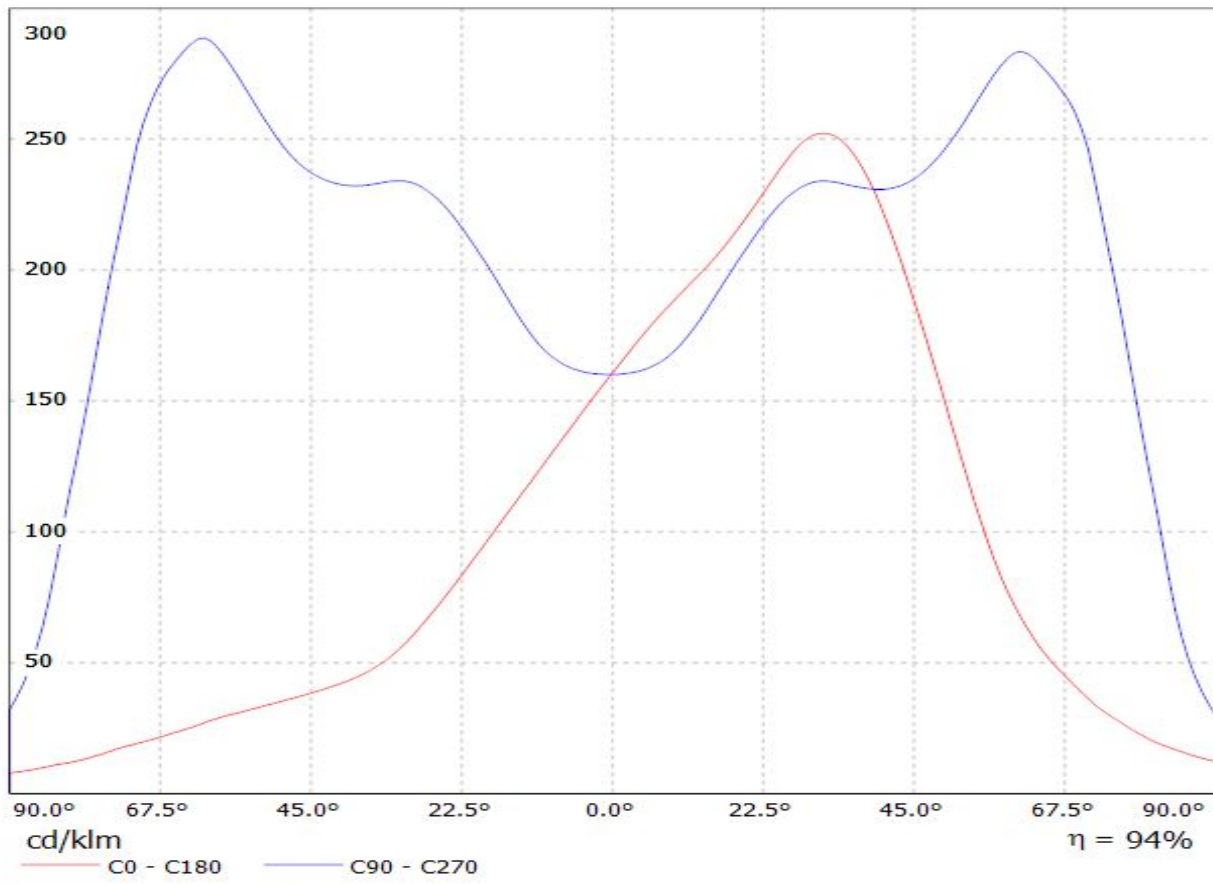

Luminaire: LEDiL Oy C12360_STRADA-2X2-DNW_(XP-L_HI)

Lamps: 1 x Cree_XP-L_HI_(2x2)_(XPLAWT-H-5A3-U60-013-0001)_455.077lm@250mA_P=2.84011W_I=0,2499A

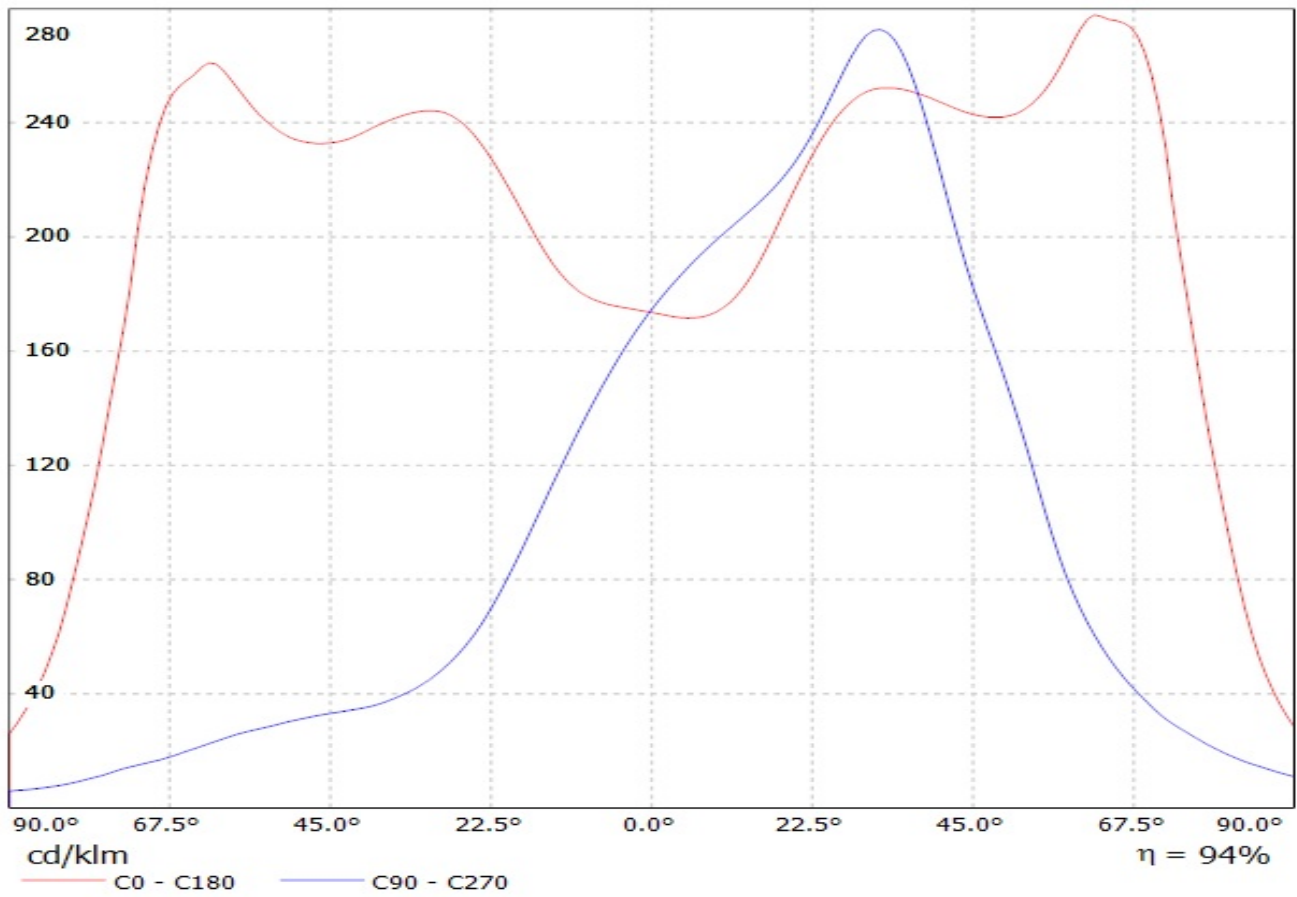

Luminaire: Ledil Oy C12360_STRADA-2X2-DNW_(XP-G3)_SIMULATED
Lamps: 1 x Cree XP-G3

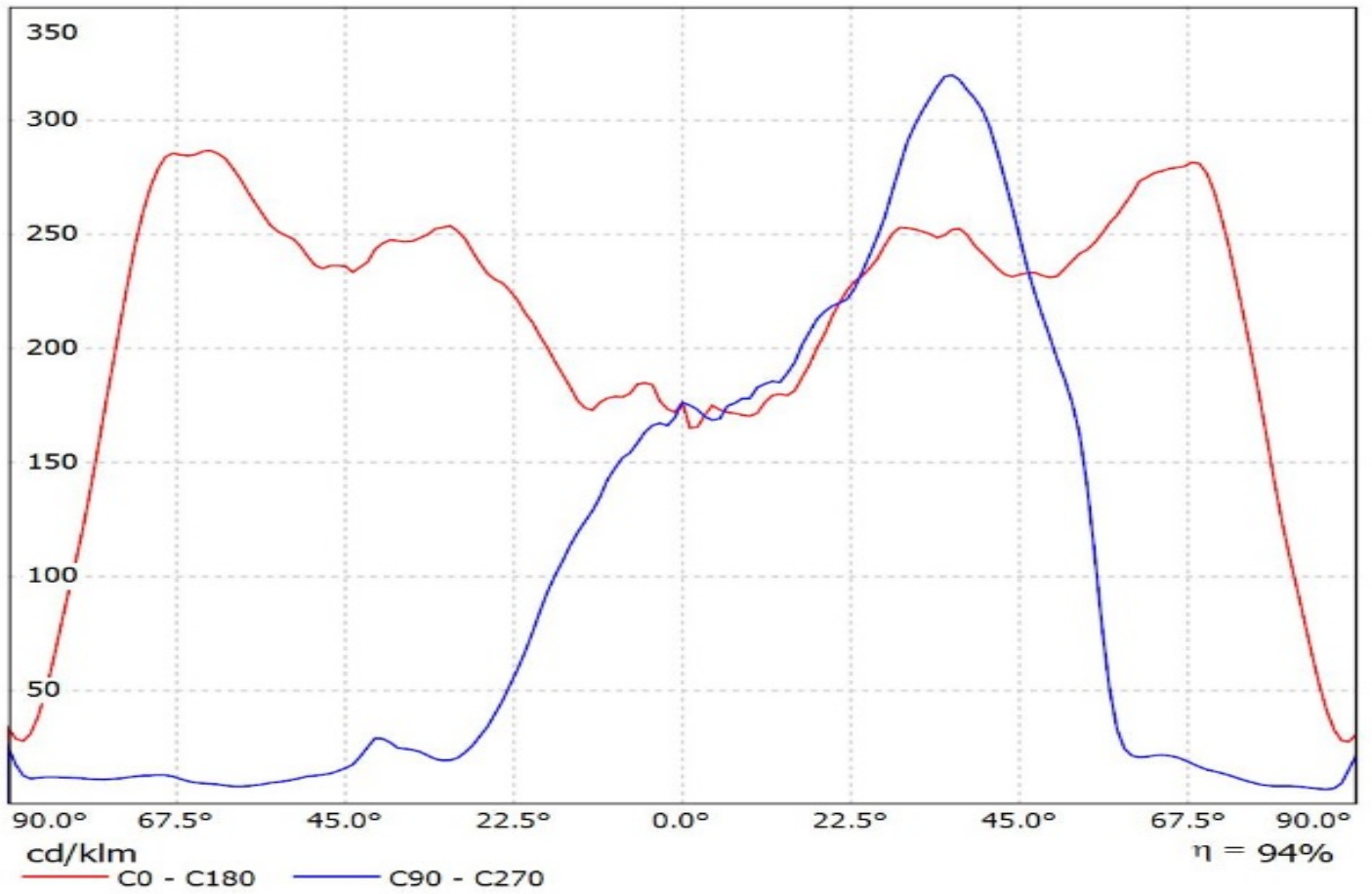

Luminaire: Ledil C12360_STRADA-2X2-DNW_(XP-L2)

Lamps: 1 x Cree_XP-L2_2x2_(XPLBWT-00-0000-000BV50E3)550.93lm@250mA_P=2.7815W_I=0.25A

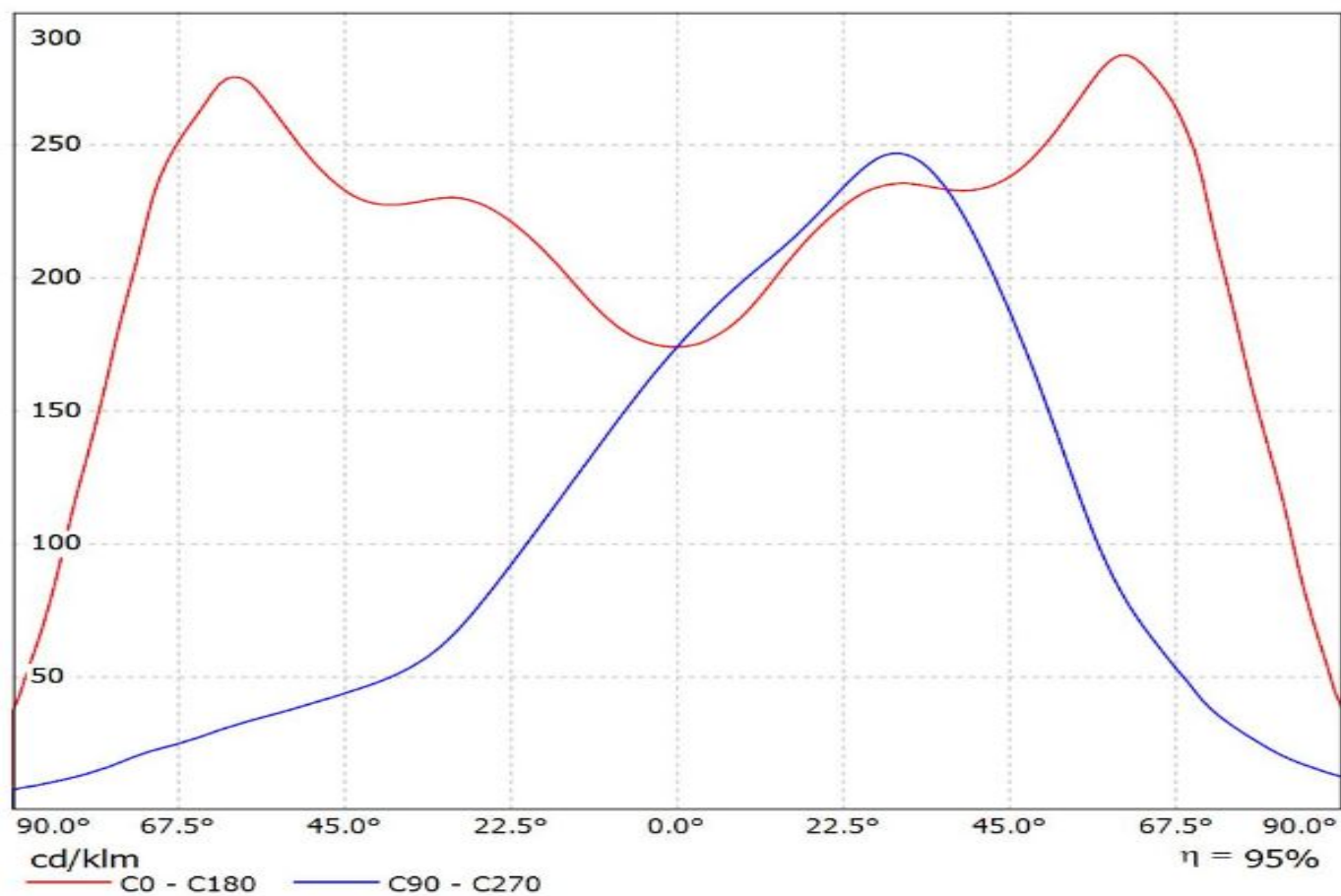

Luminaire: LEDiL Oy C12360_Strada-2x2-DNW_(LG3535) Eff. 93,5%
Lamps: 1 x LG Ceramic 3535 PKG (372lm@250mA)

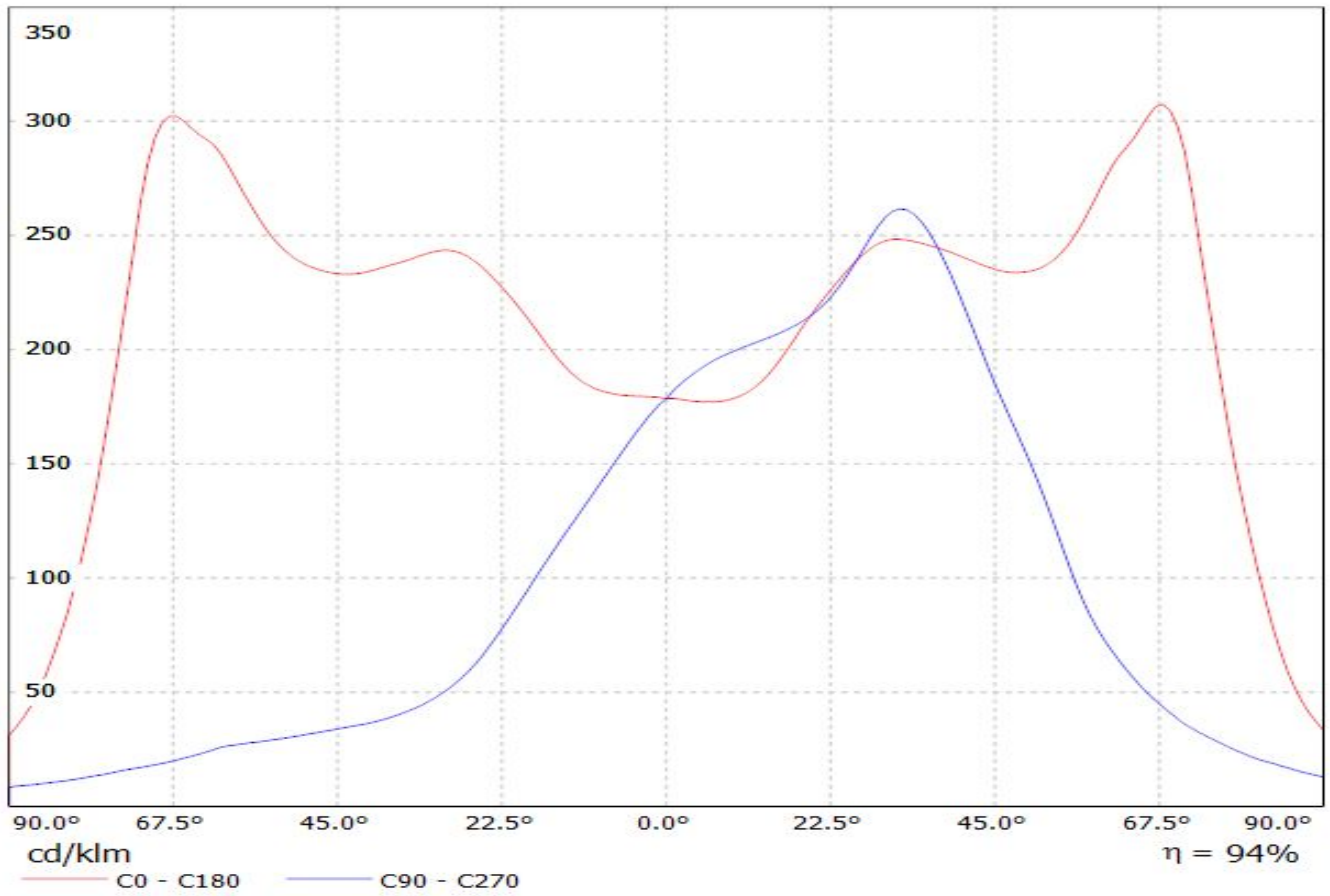

Luminaire: Ledil Oy C12360_STRADA-2X2-DNW-RE-ES Efficiency=93%
Lamps: 1 x Luxeon Rebel ES 250mA 366lm

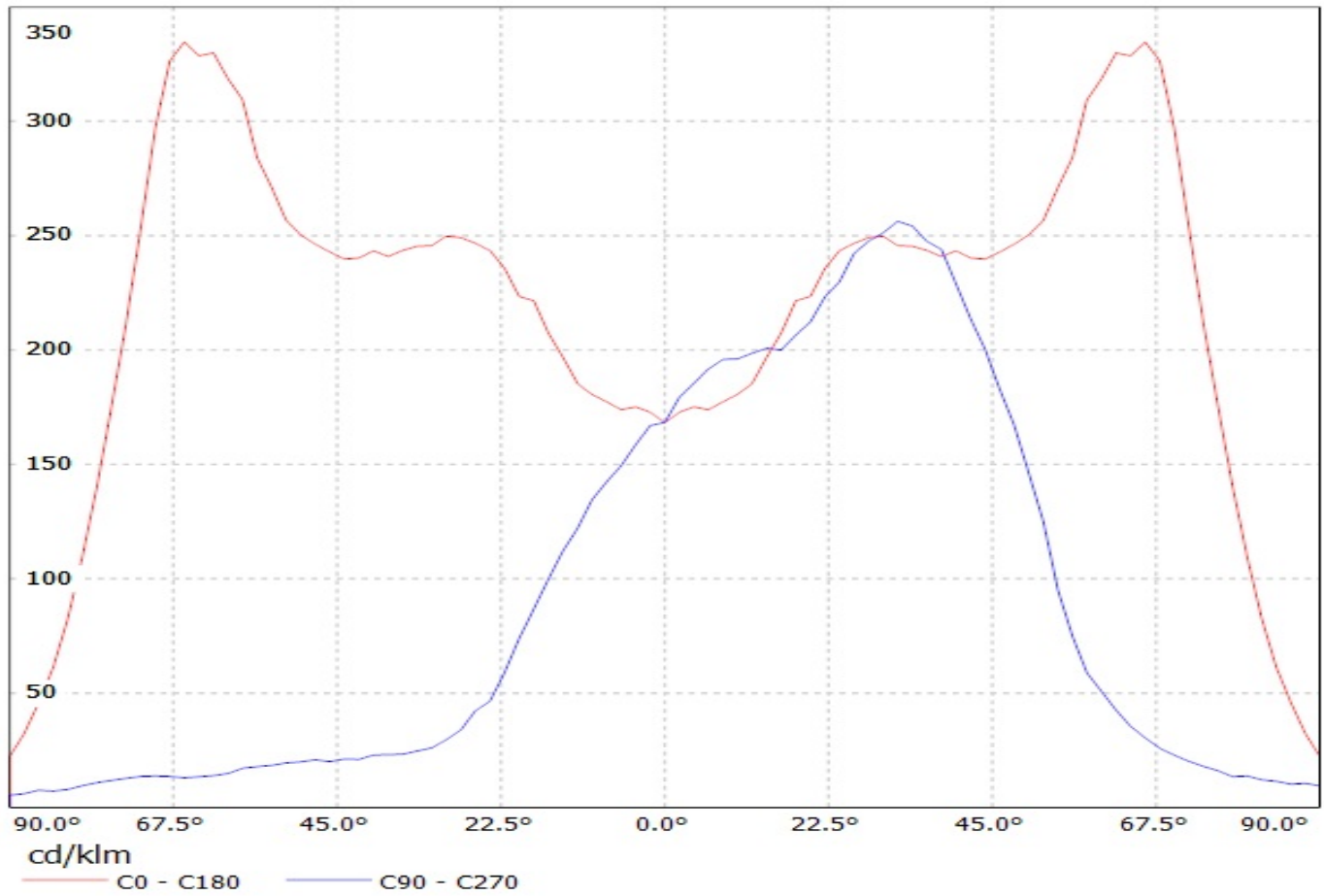

Luminaire: LEDiL Oy C12360_Strada_2x2_DNW_(LUXEON_T) Eff.92.5%
Lamps: 1 x LUXEON_T 2x2 (294lm@250mA)

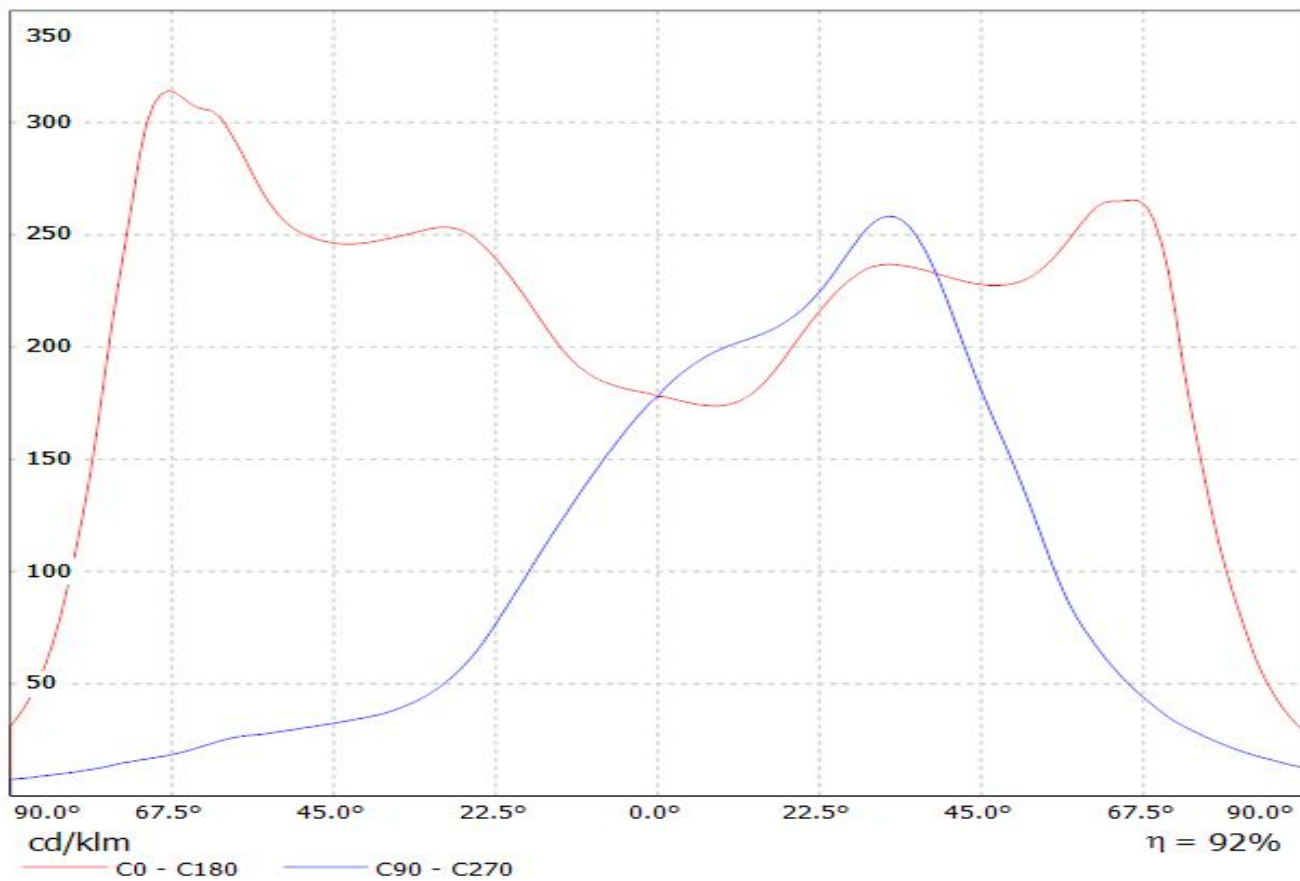

Luminaire: LEDiL Oy C12360_STRADA-2X2-DNW_(Luxeon-Z-ES) Eff: 94%
Lamps: 1 x Luxeon Z ES 2x2 (LX22-3090) 209.277lm@250mA_P=2.81W_I=0.2499A

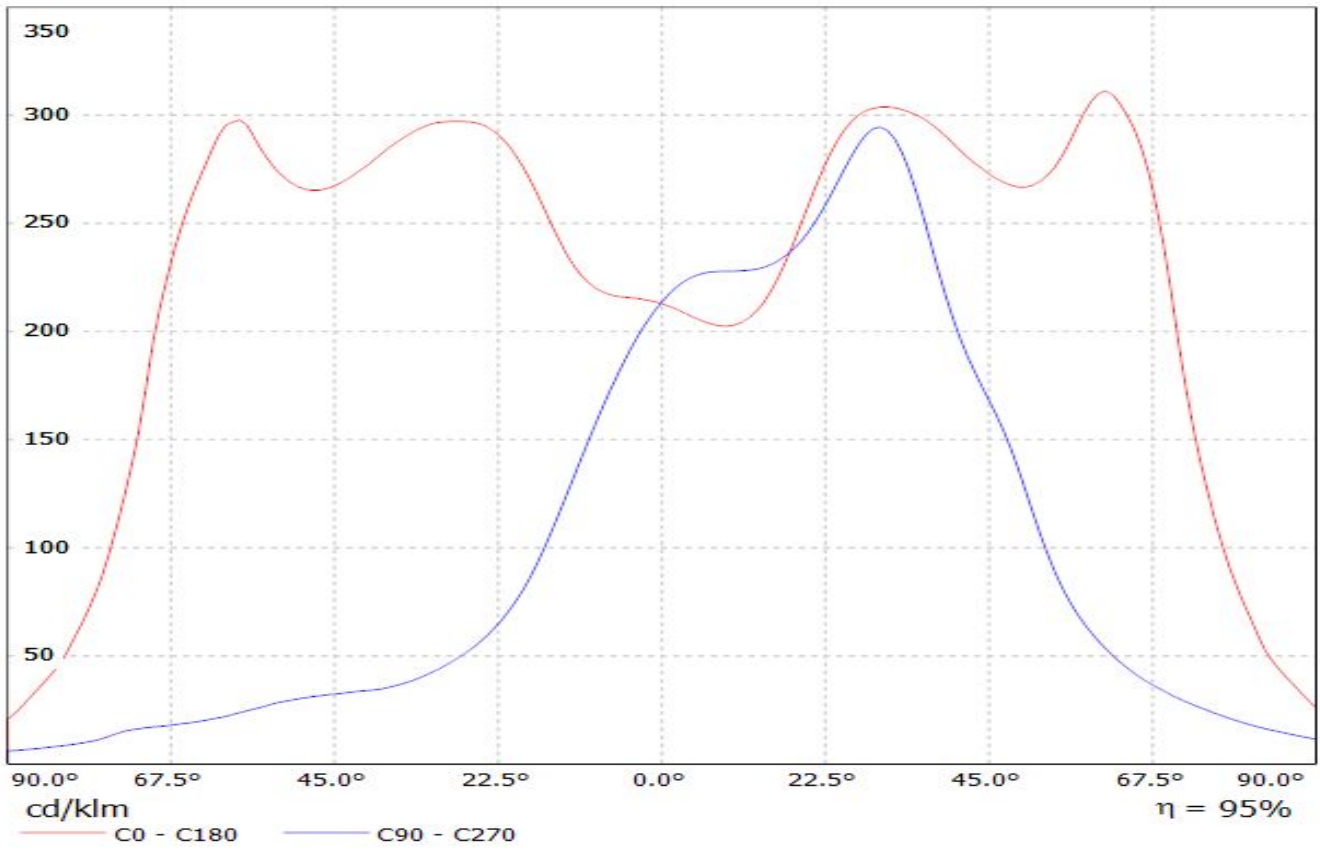

Luminaire: LEDiL Oy C12360_STRADA-2X2-DNW_(LUXEON_Q) Eff.93.7%
Lamps: 1 x LUXEON_Q_2x2_(LHQ-3080)_299.038lm@250mA_P=2.8742W_I=249.8mA

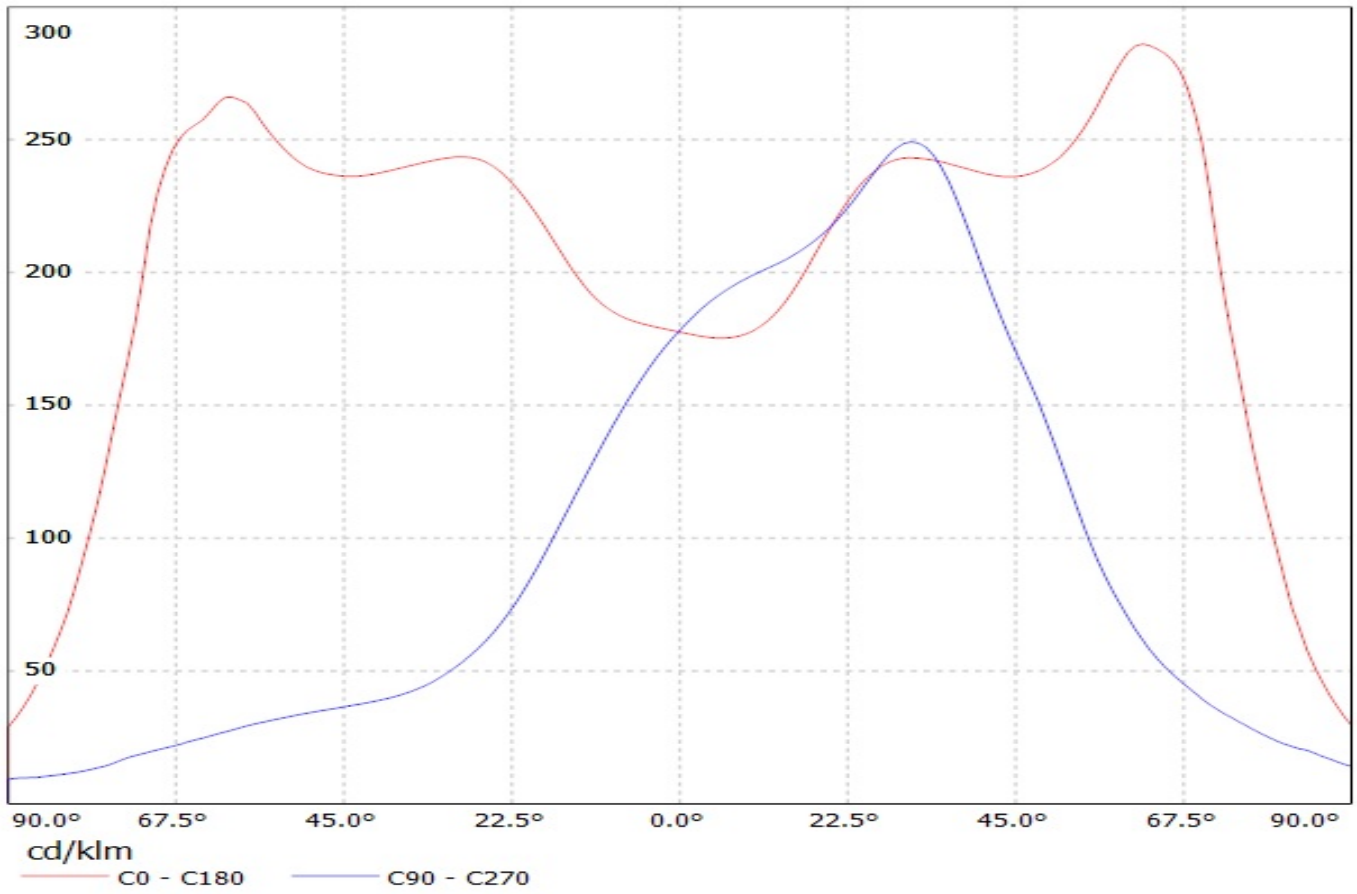

Luminaire: Ledil C12360_STRADA-2X2-DNW_(Luxeon_MZ)

Lamps: 1 x Philips_Lumileds_Luxeon_MZ_(LMZ7-QW57)_(2x2)_427.268lm@250mA_P=2.734W_η=0.2500A

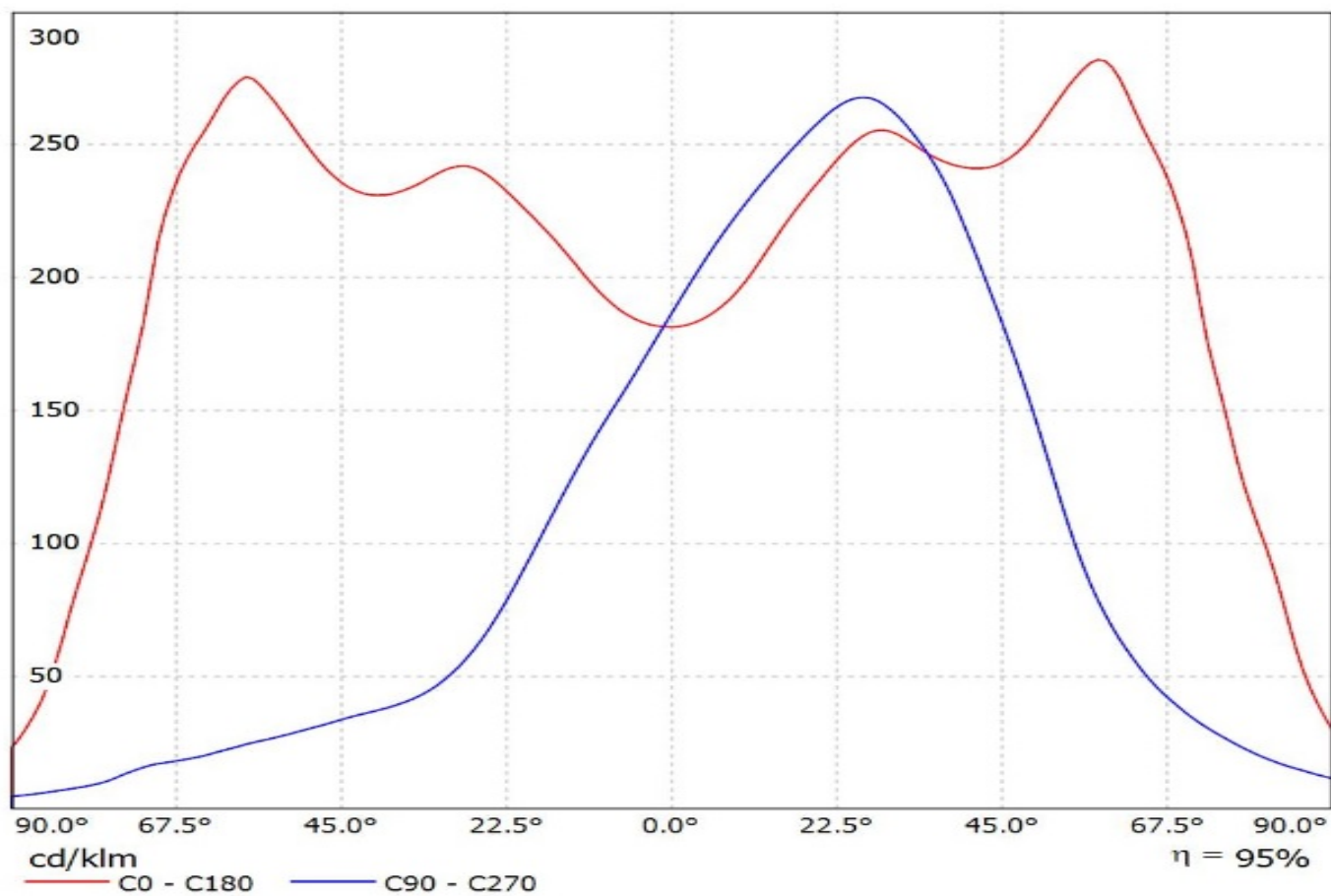

Luminaire: LEDiL Oy C12360_STRADA-2X2-DNW_(E21A)
Lamps: 1 x Nichia_E21A_452.248lm@250mA_2.805W_I=0.250A

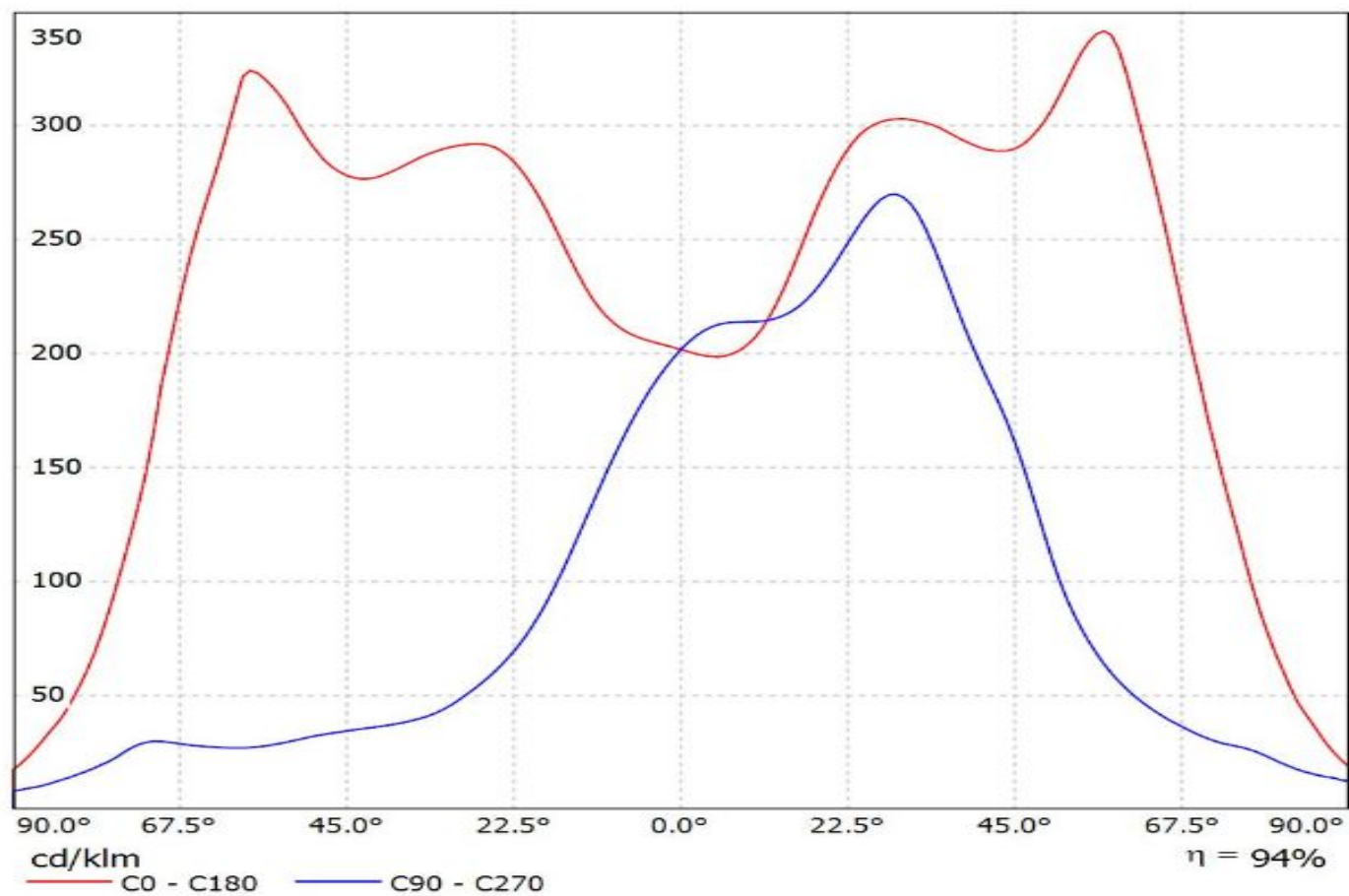

Luminaire: LEDiL Oy C12360_STRADA-2X2-DNW_(NVSW319AE)
Lamps: 1 x Nichia_NVSW319AE_499.093lm@250mA_P=2.79052W_I=0.25A

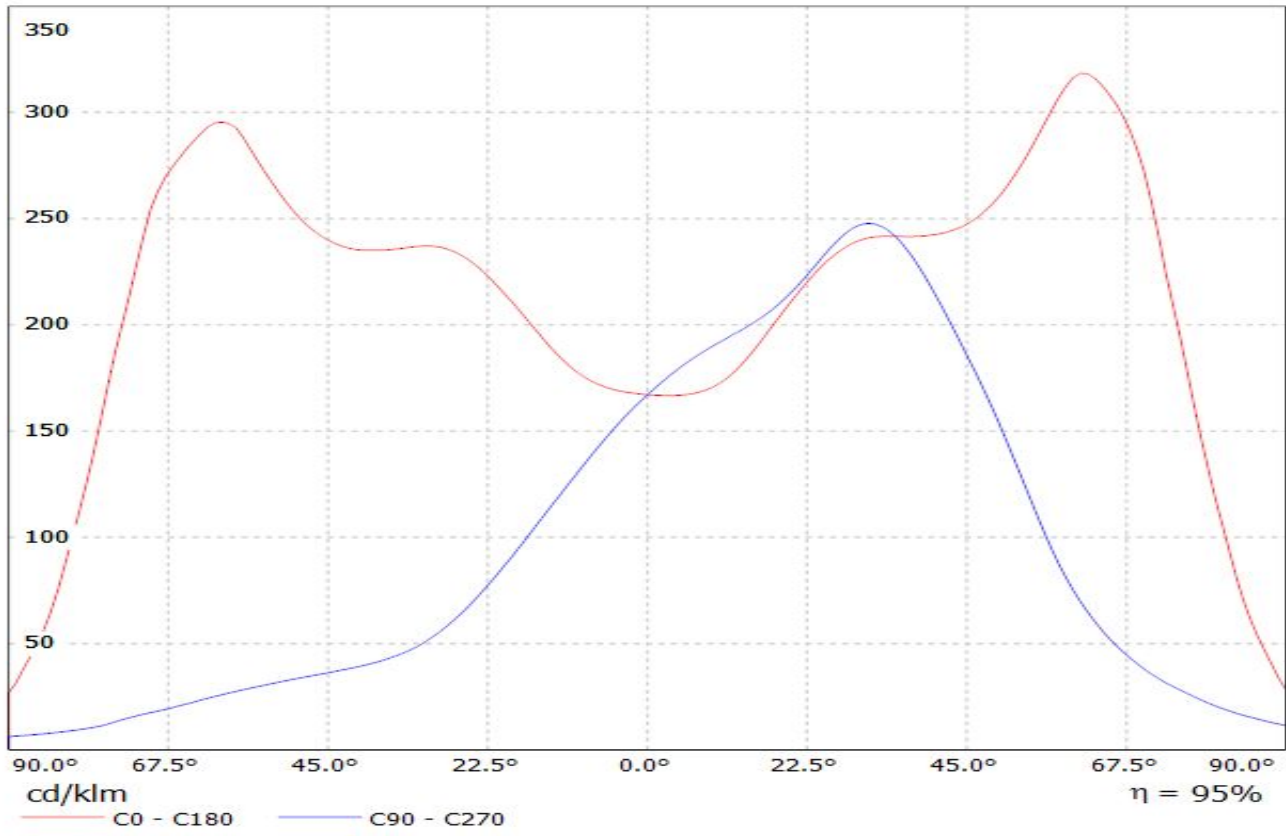

Luminaire: Ledil Oy C11918_STRADA-T-6X1-DNW (Osram Square PC 398lm @ 250mA) Efficiency=93%
Lamps: 1 x Osram Square PC 398lm @ 250mA

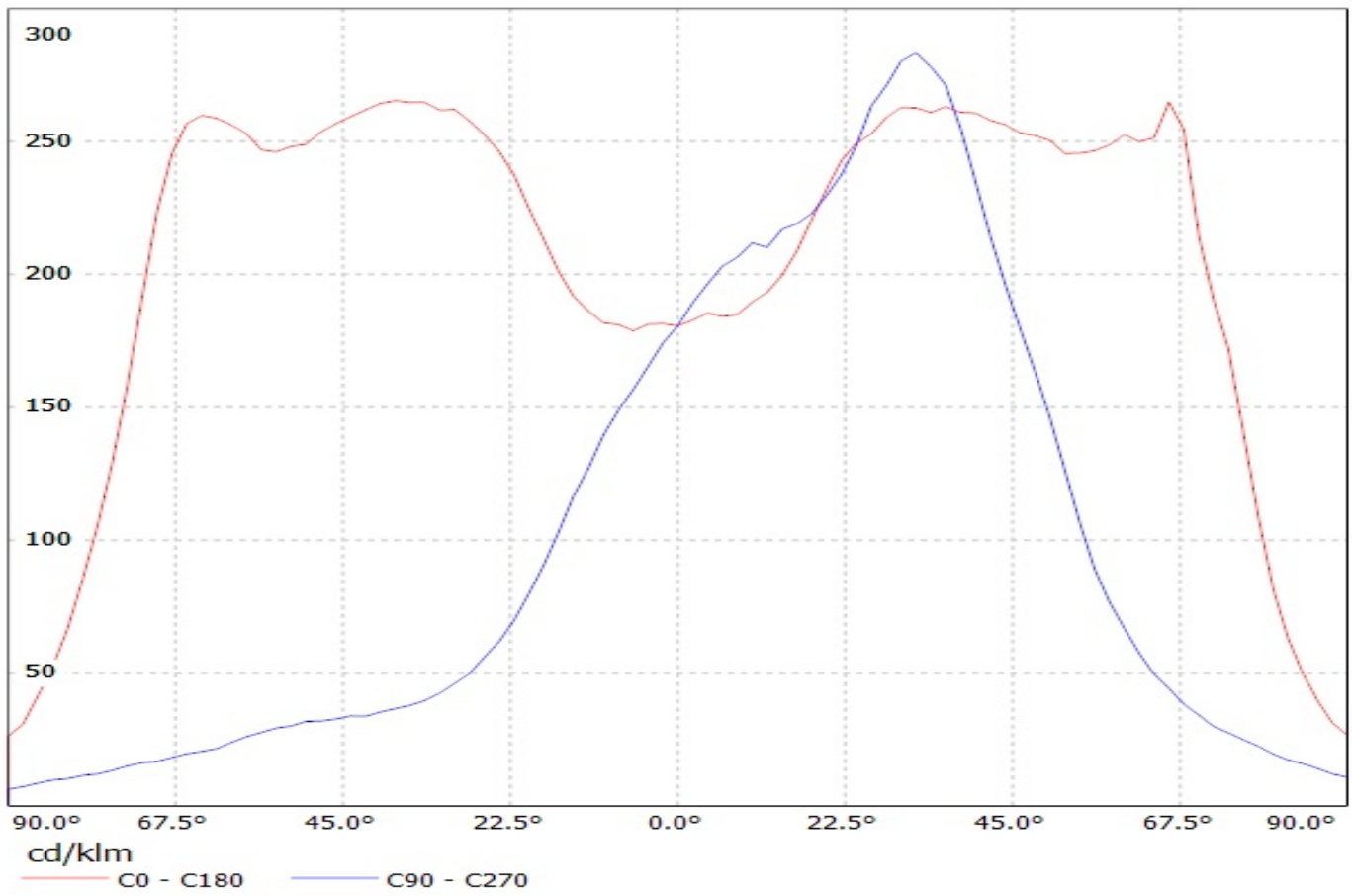

Luminaire: Ledil C12360_STRADA-2X2-DNW(square_gen3)

Lamps: 1 x Osram_square_gen3_2x2_(GW_CSSRM2.PM)_460.271lm@250mA_CCT=5000K_P=2.80625W_I=0.25A

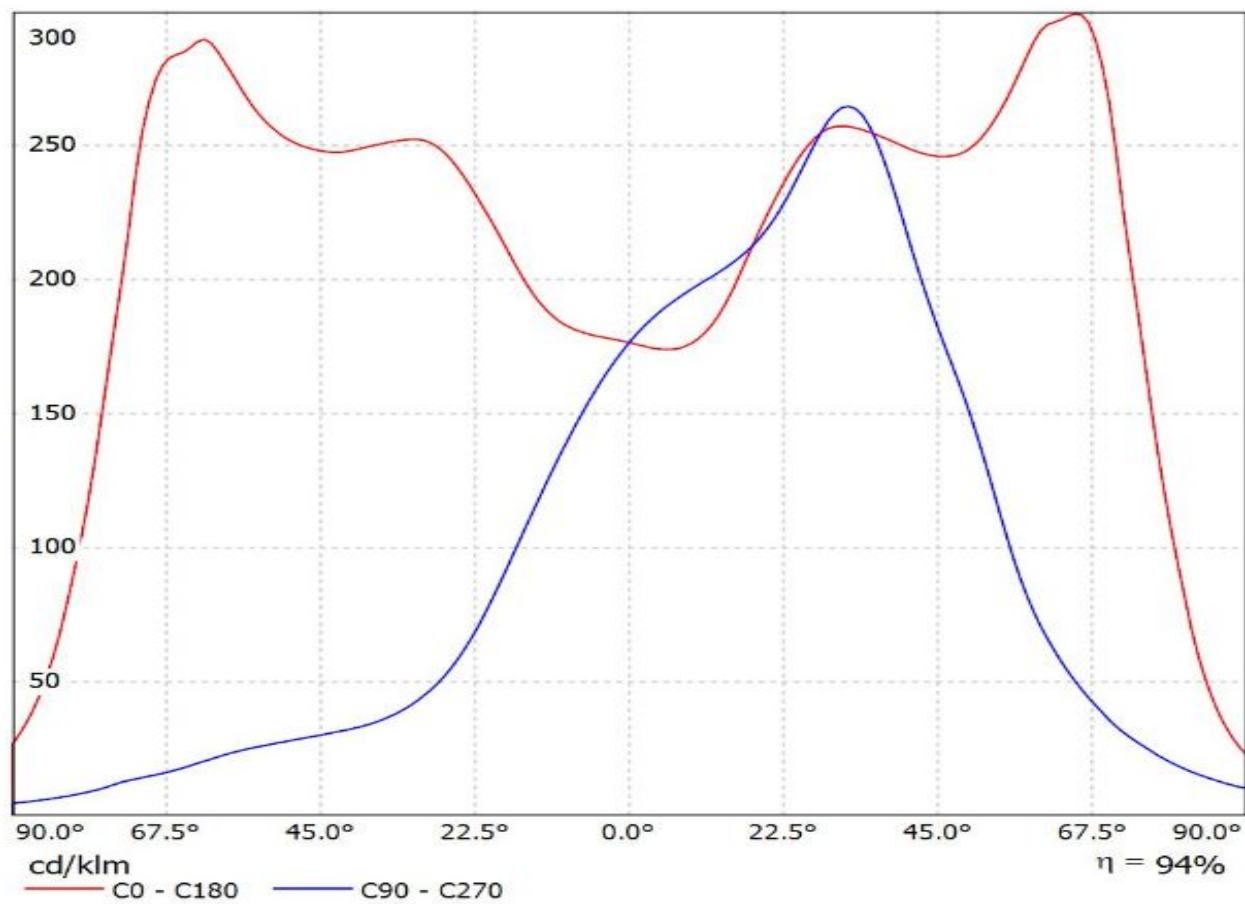

Luminaire: Ledil Oy C12362_STRADA-2X2-DWC_(Duris_P8)_SIMULATED
Lamps: 1 x Osram Duris P8

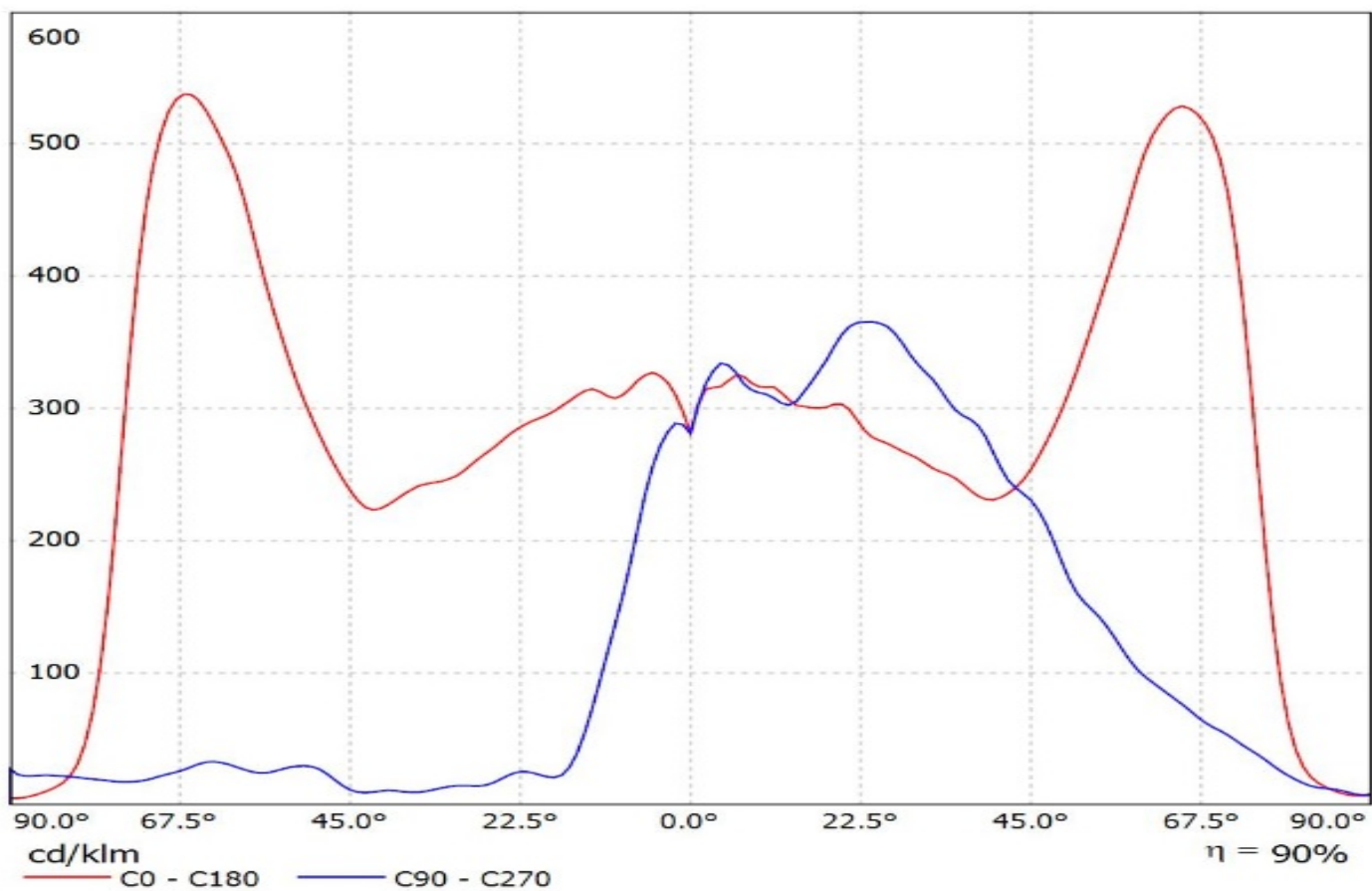

Luminaire: LEDiL Oy C12360_STRADA-2X2-DNW_(Fortimo_F-Flex_2x8_740DAG3)

Lamps: 1 x Philips_Fortimo_FastFlex_LED_board_2x8/740_DA_G3_1795.7lm@250mA_P=11.6015W_I=0.2498A

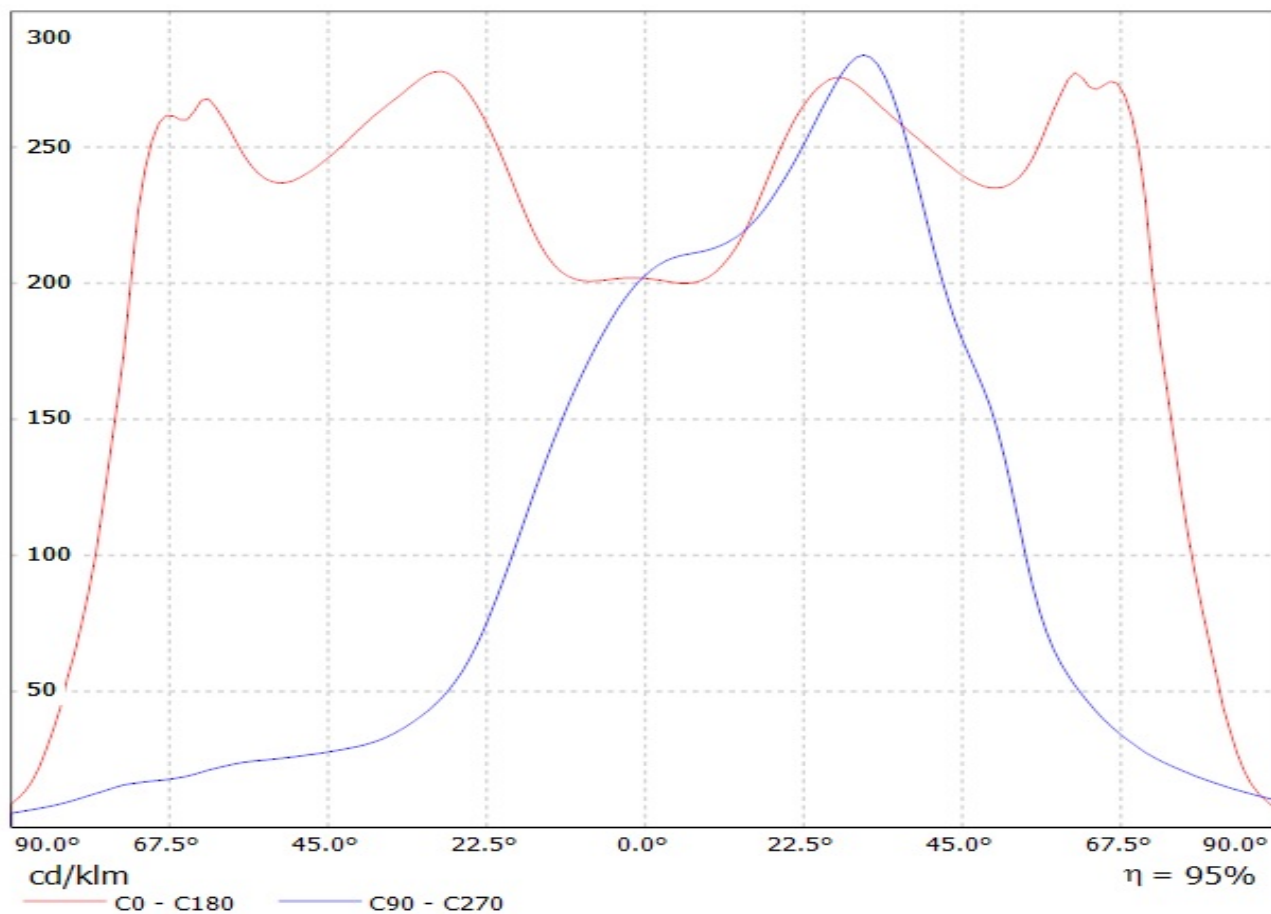

Luminaire: LEDiL Oy C12360_STRADA-2X2-DNW_(LH351B)

Lamps: 1 x SAMSUNG_LH351B_2x2_437.85lm@250mA_P=2.84311W_I=249.9mA

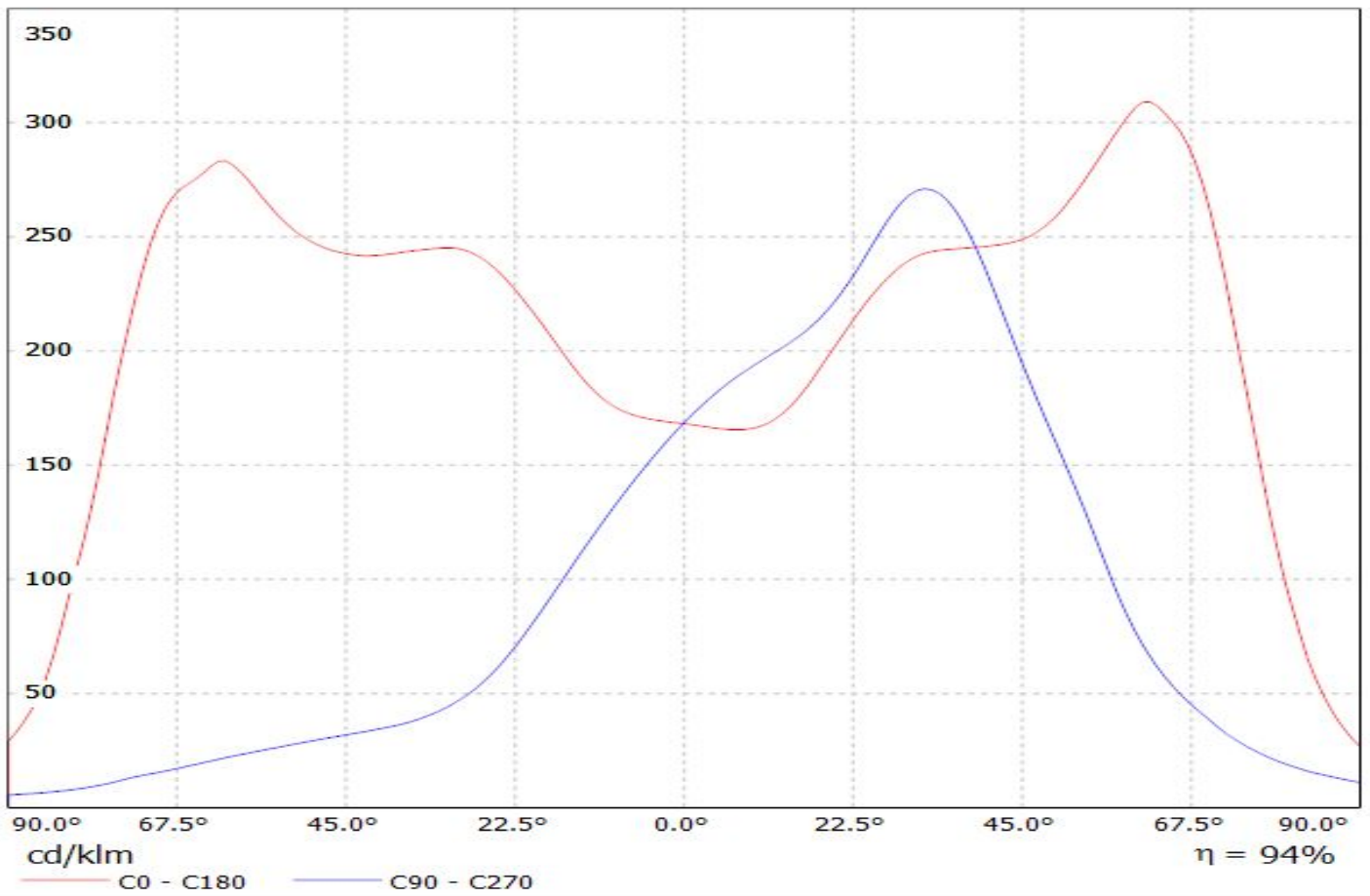

Luminaire: LEDiL Oy C12360_STRADA-2X2-DNW_(LH351Z) Eff: 94%
Lamps: 1 x SAMSUNG_LH351Z_2x2_364.45lm@250mA_P=2.86596W_I=249.8mA

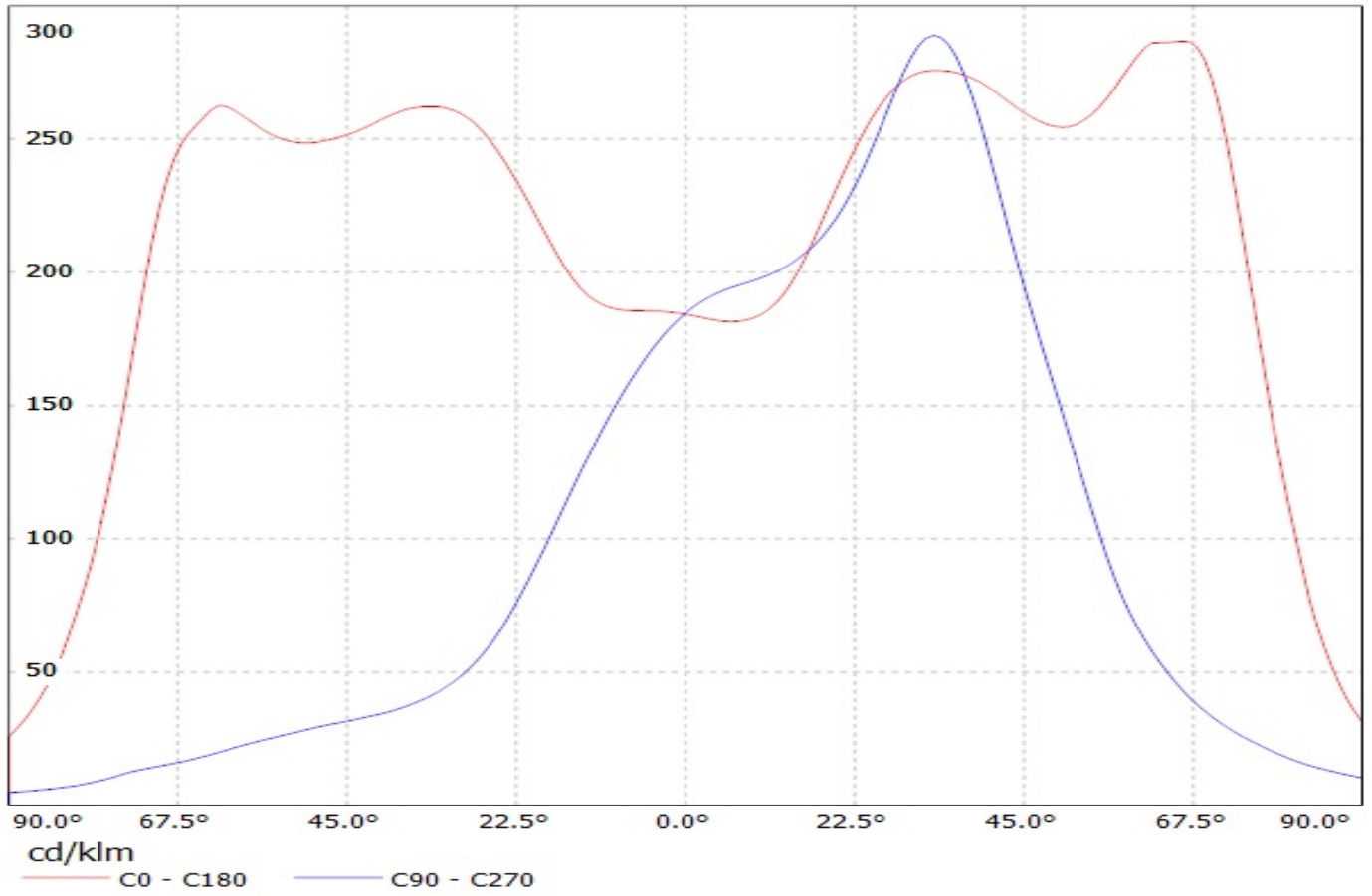

Luminaire: Ledil C12360_STRADA-2X2-DNW_(LH351D)
Lamps: 1 x Samsung_LH351D_536.957lm@250mA_P=2.7695W_I=0.250A

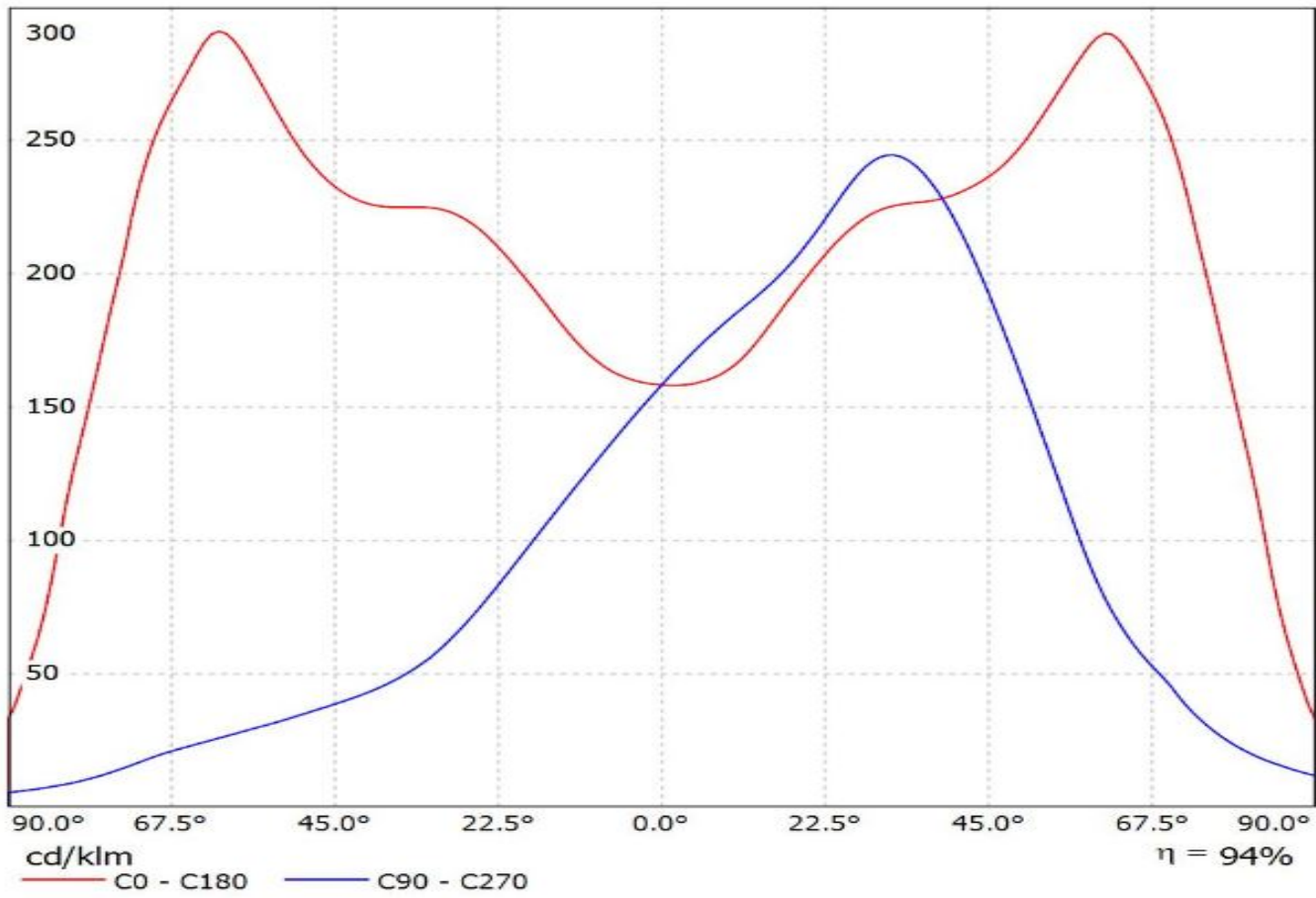

LEDiL Oy C12360_STRADA-2x2-DNW_(MJT4040) Eff.94.0% / LDC (Linear)

Luminaire: LEDiL Oy C12360_STRADA-2x2-DNW_(MJT4040) Eff.94.0%

Lamps: 1 x SEOUL ACHRICH MJT4040 (SAW09H0A) 251.5lm@40mA P=2.37W I=40mA

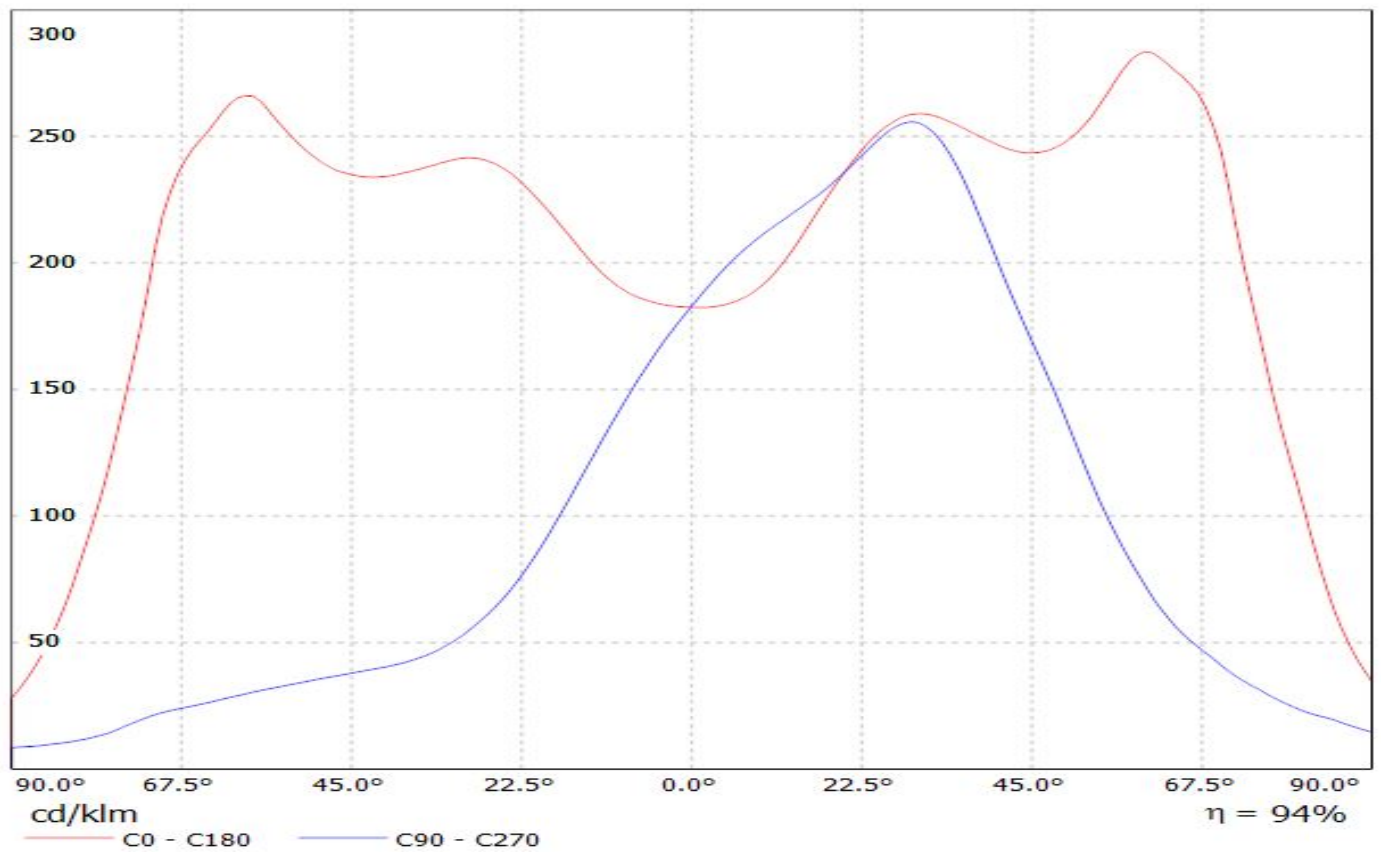

Luminaire: LEDil Oy C12360_STRADA-2X2-DNW_(Z5M1) Efficiency=94%
Lamps: 1 x Seoul Z5M1 (SZ5-M1-WN-C8) 379lm @ 250mA CCT=4600K P=2.9W I=250mA

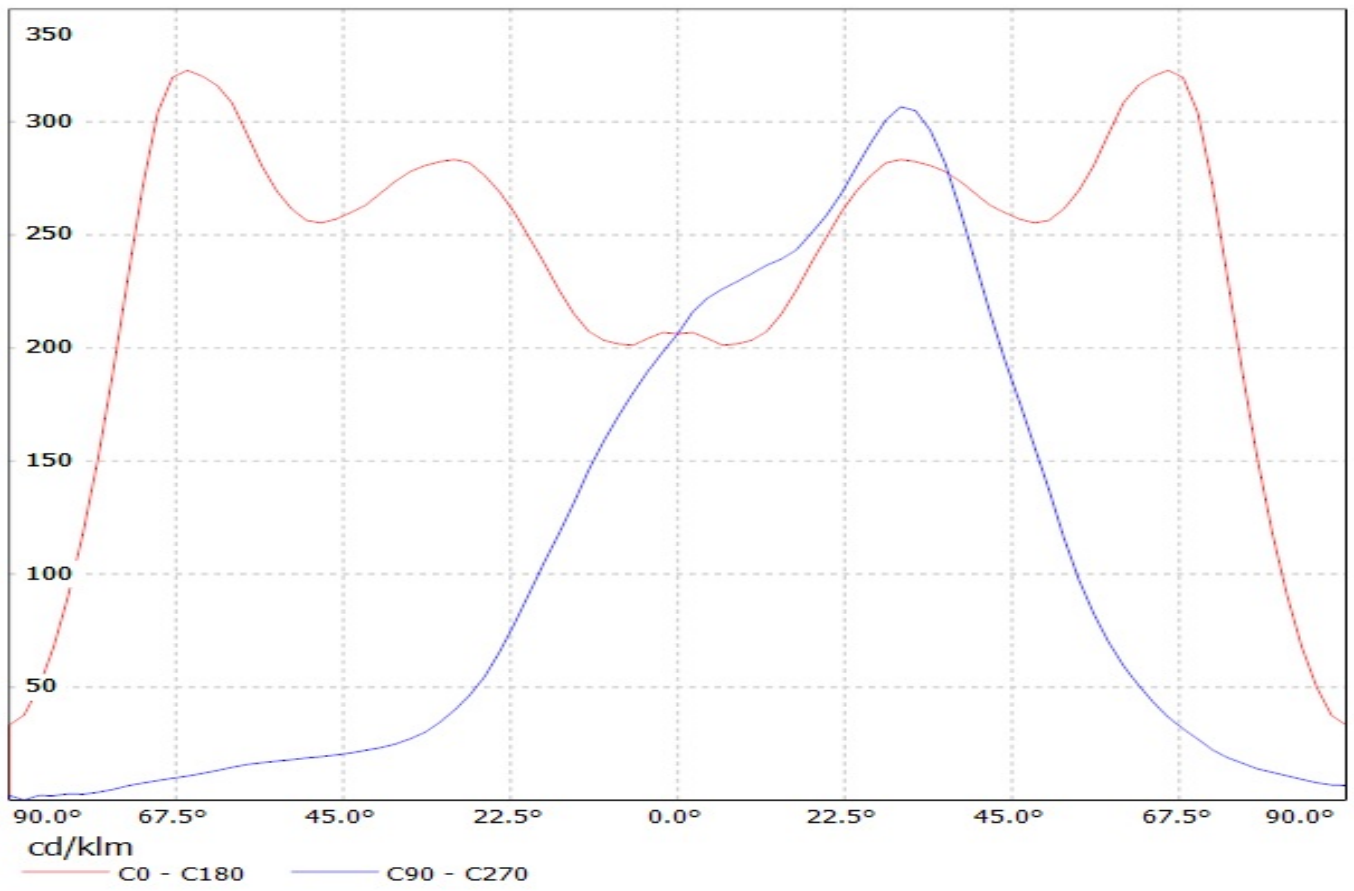

Ledil C12360_STRADA-2X2-DNW_(TL1L3) / LDC (Linear)

Luminaire: Ledil C12360_STRADA-2X2-DNW_(TL1L3)

Lamps: 1 x Toshiba_TL1L3_2x2_(TL1L3-NW1.L)_387.773lm@250mA_CCT=5000K_P=2.829W_I=0.25A

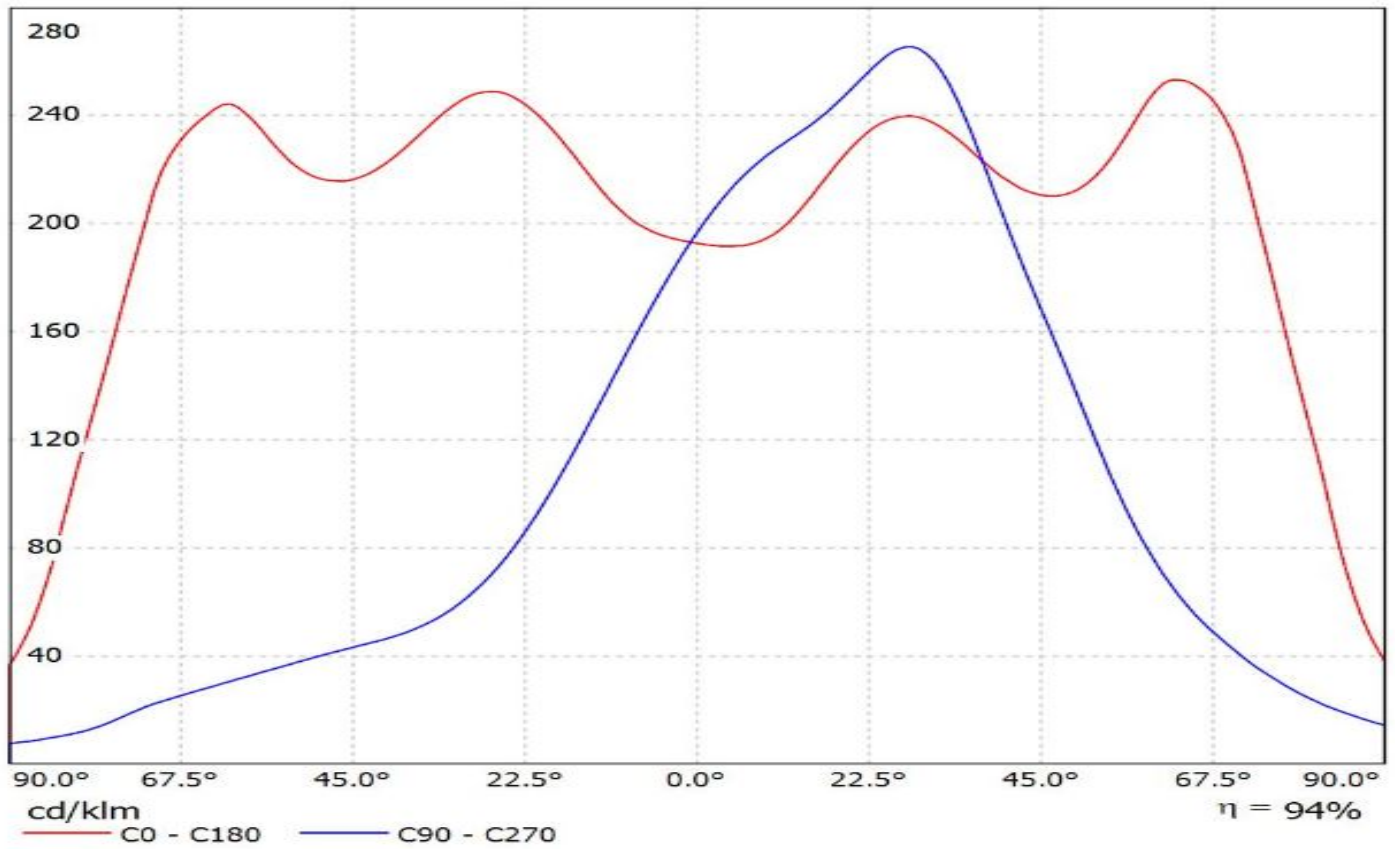

Ledil C12360_STRADA-2X2-DNW_(TL1L4) / LDC (Linear)

Luminaire: Ledil C12360_STRADA-2X2-DNW_(TL1L4)

Lamps: 1 x Toshiba_TL1L4_2x2_(TL1L4-DW0)_472.639lm@250mA_CCT=6500K_P=2.9W_I=0.25A

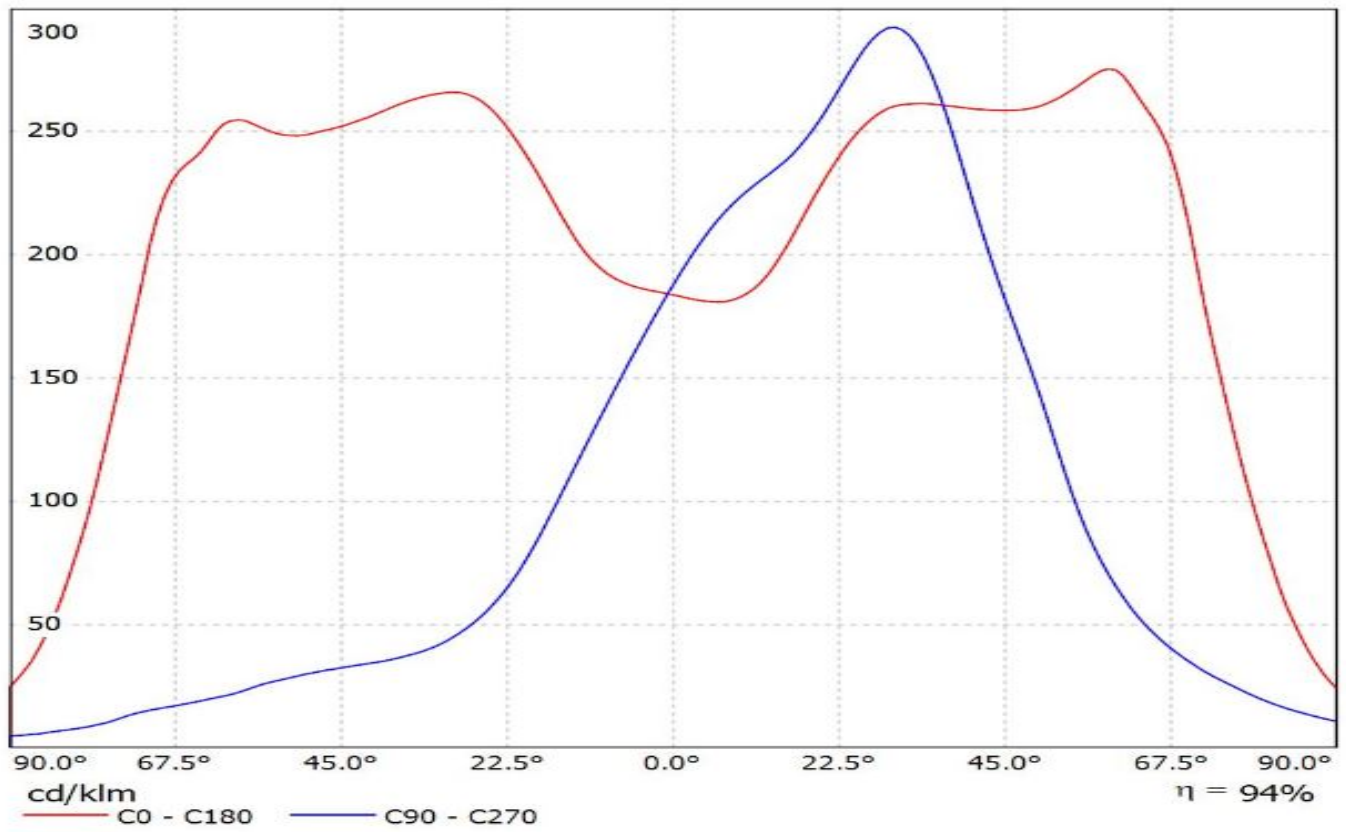

Luminaire: LEDiL Oy C12360_STRADA-2X2-DNW_(Tridonic_Module_RLE_G1)
Lamps: 1 x Tridonic_Module_RLE_G1_4576.03lm@700mA_P=32.0681W_I=0.700A

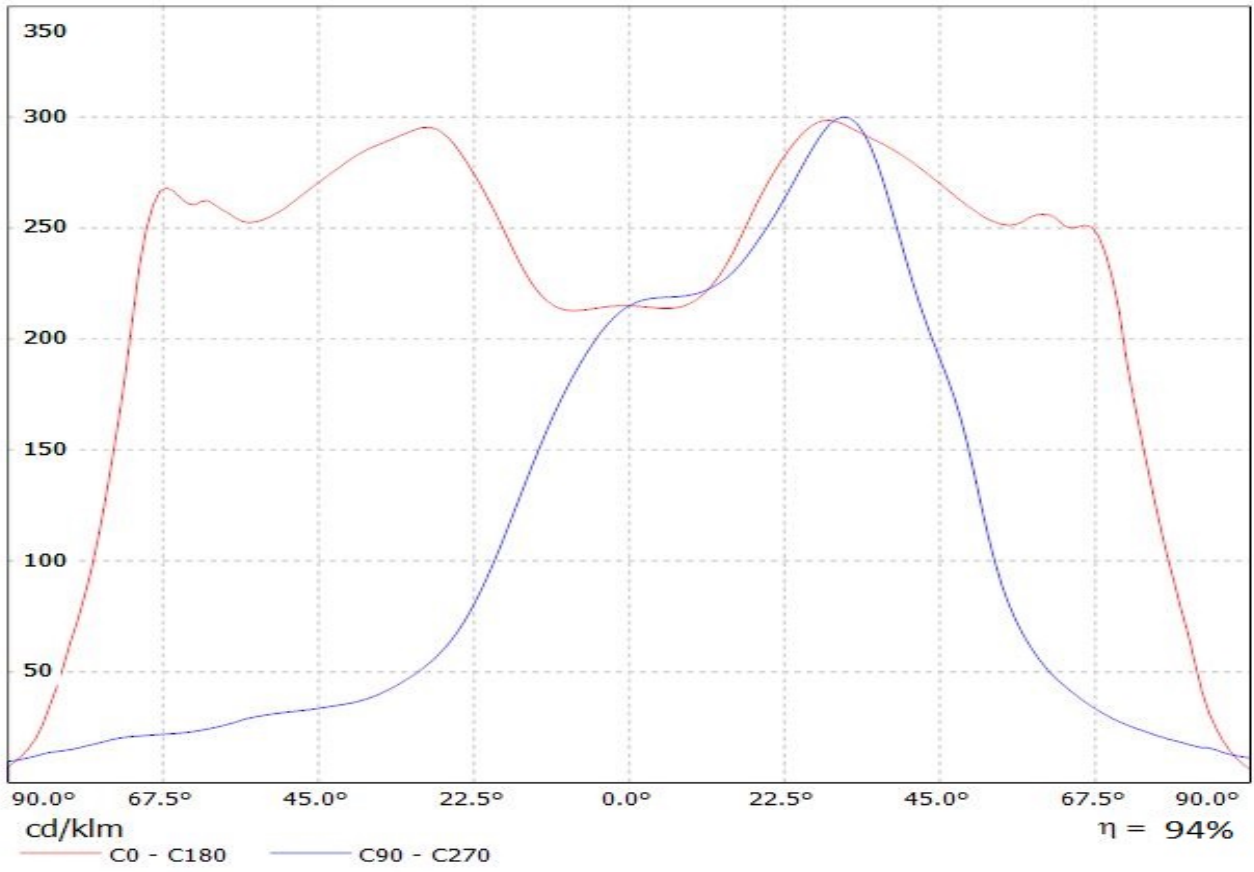

Luminaire: LEDiL Oy C12360_STRADA-2X2-DNW_(Tridonic_Module_RLE_G1)
Lamps: 1 x Tridonic_Module_RLE_G1_4576.03lm@700mA_P=32.0681W_I=0.700A

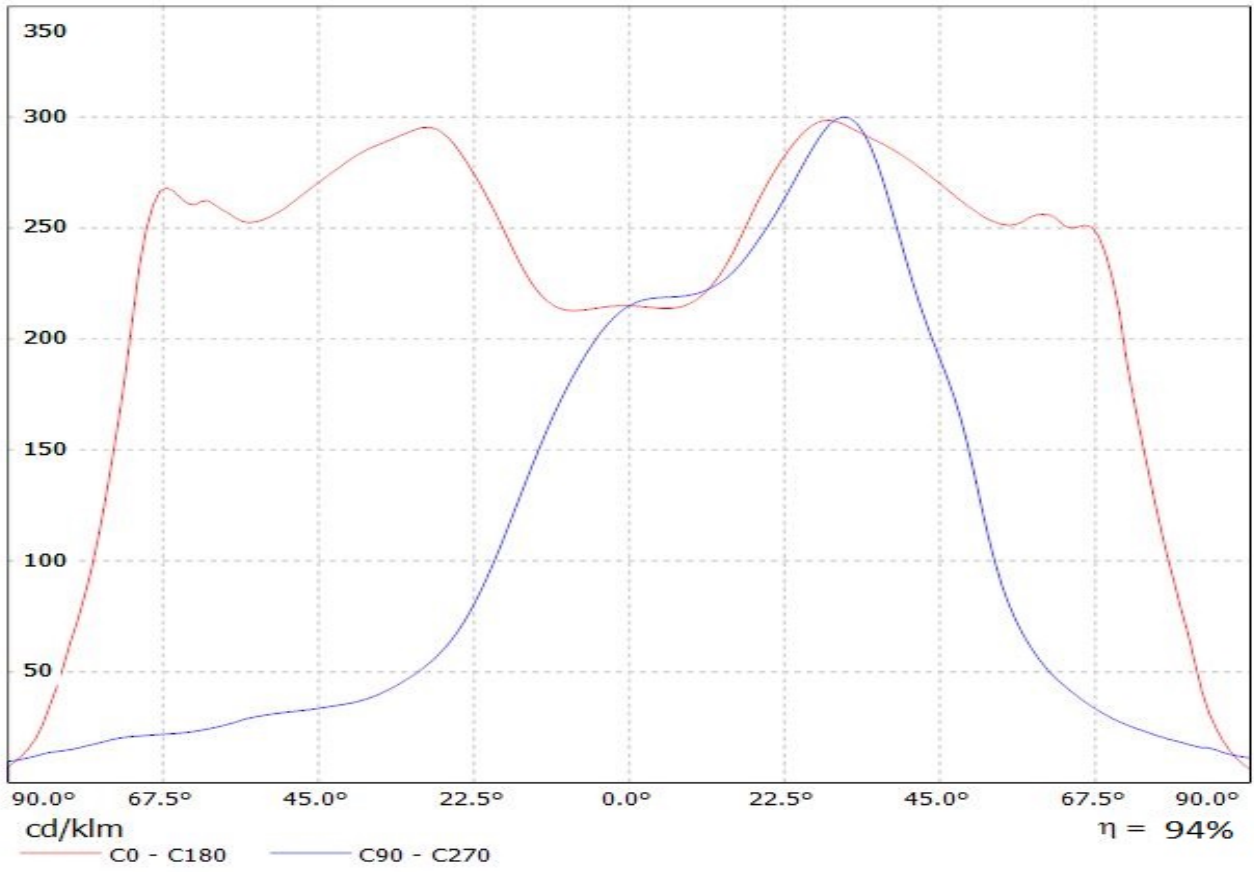

Luminaire: LEDiL Oy C12360_STRADA-2X2-DNW_(Tridonic_Module_RLE_G1)
Lamps: 1 x Tridonic_Module_RLE_G1_2288lm@700mA_P=16W_I=0.700A

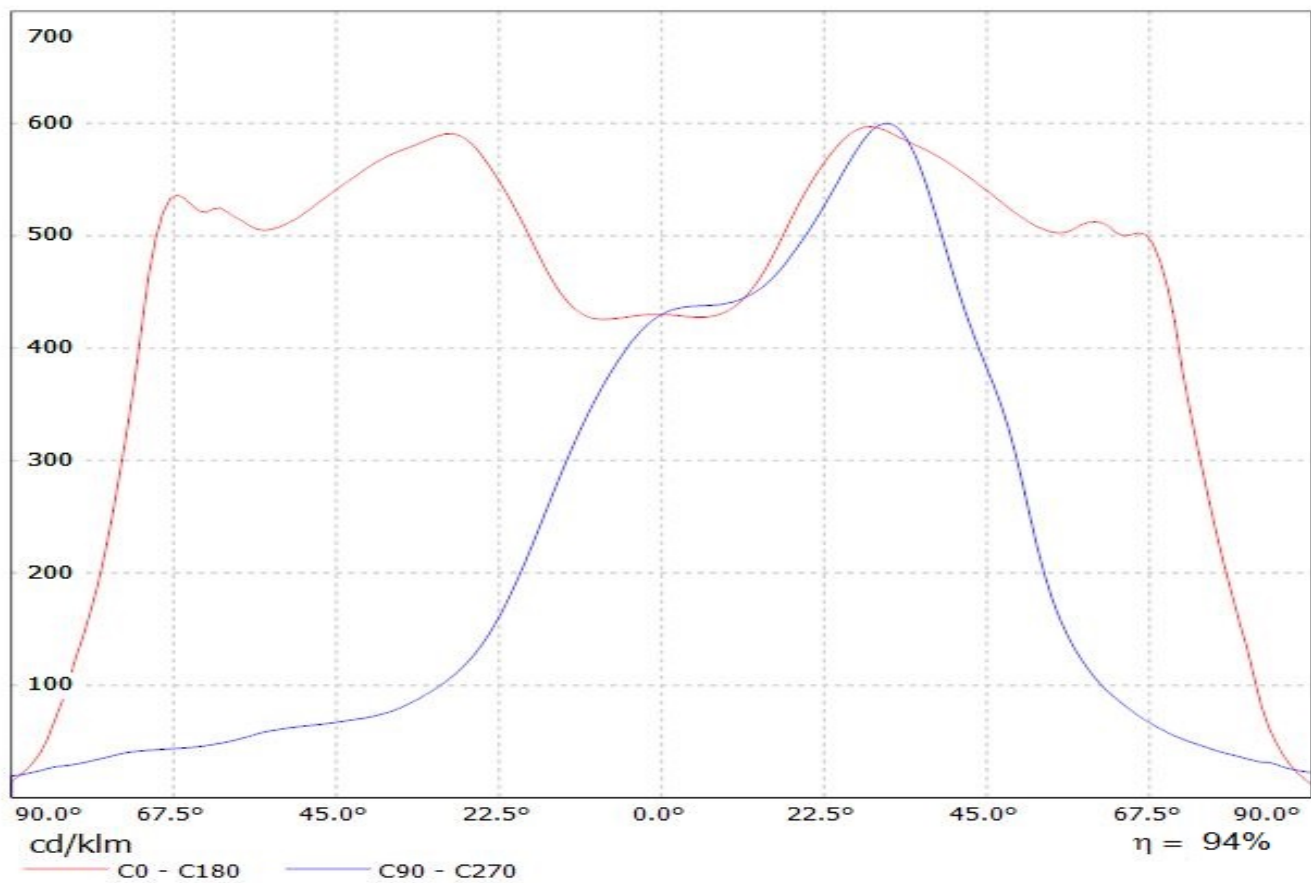

Luminaire: LEDiL Oy C12360_STRADA-2X2-DNW_(Tridonic_Module_RLE_G1)
Lamps: 1 x Tridonic_Module_RLE_G1_2288lm@700mA_P=16W_I=0.700A

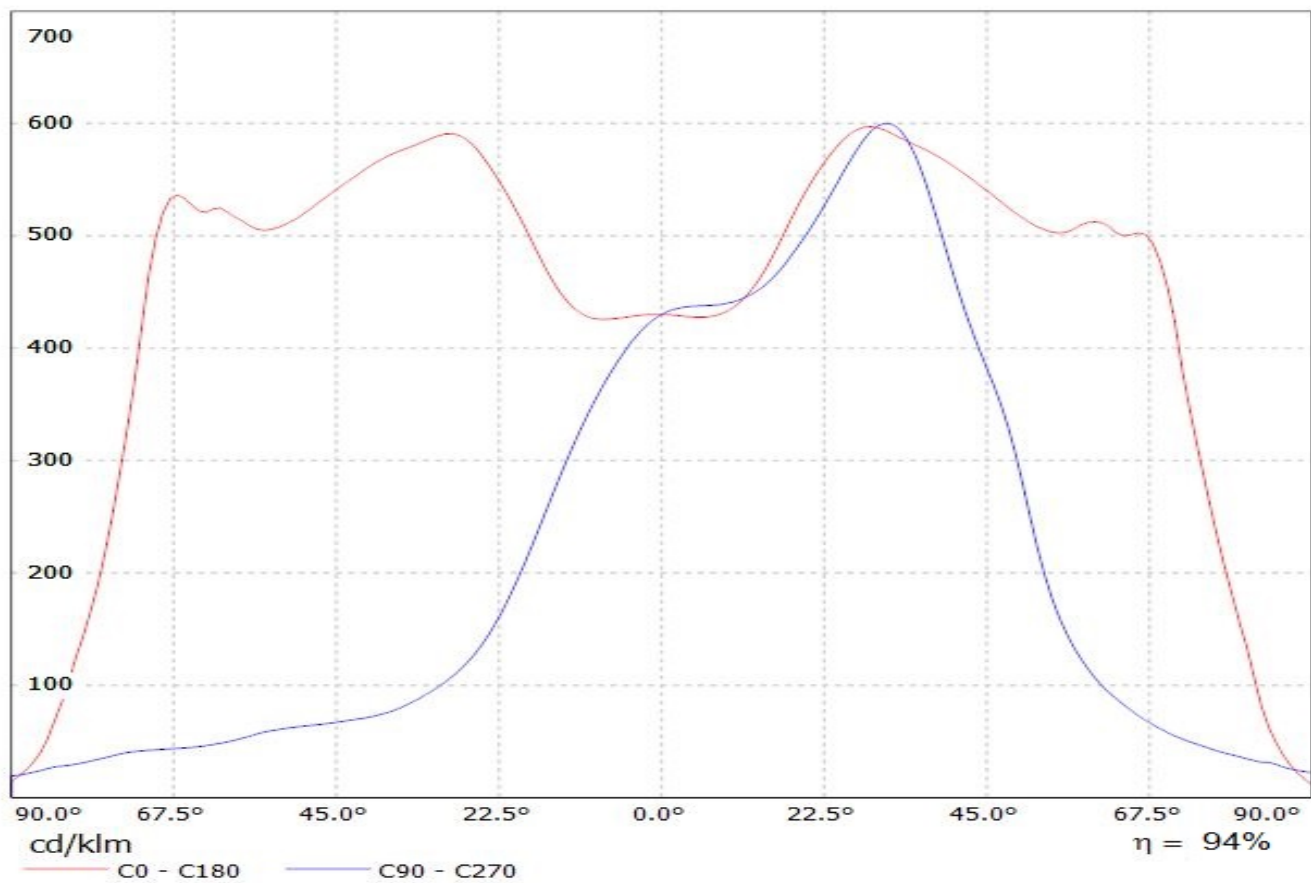

Luminaire: Ledil Oy C12360_Strada-2x2-DNW-XM-L Eff.93%
Lamps: 1 x Cree XM-L 400lm@250mA

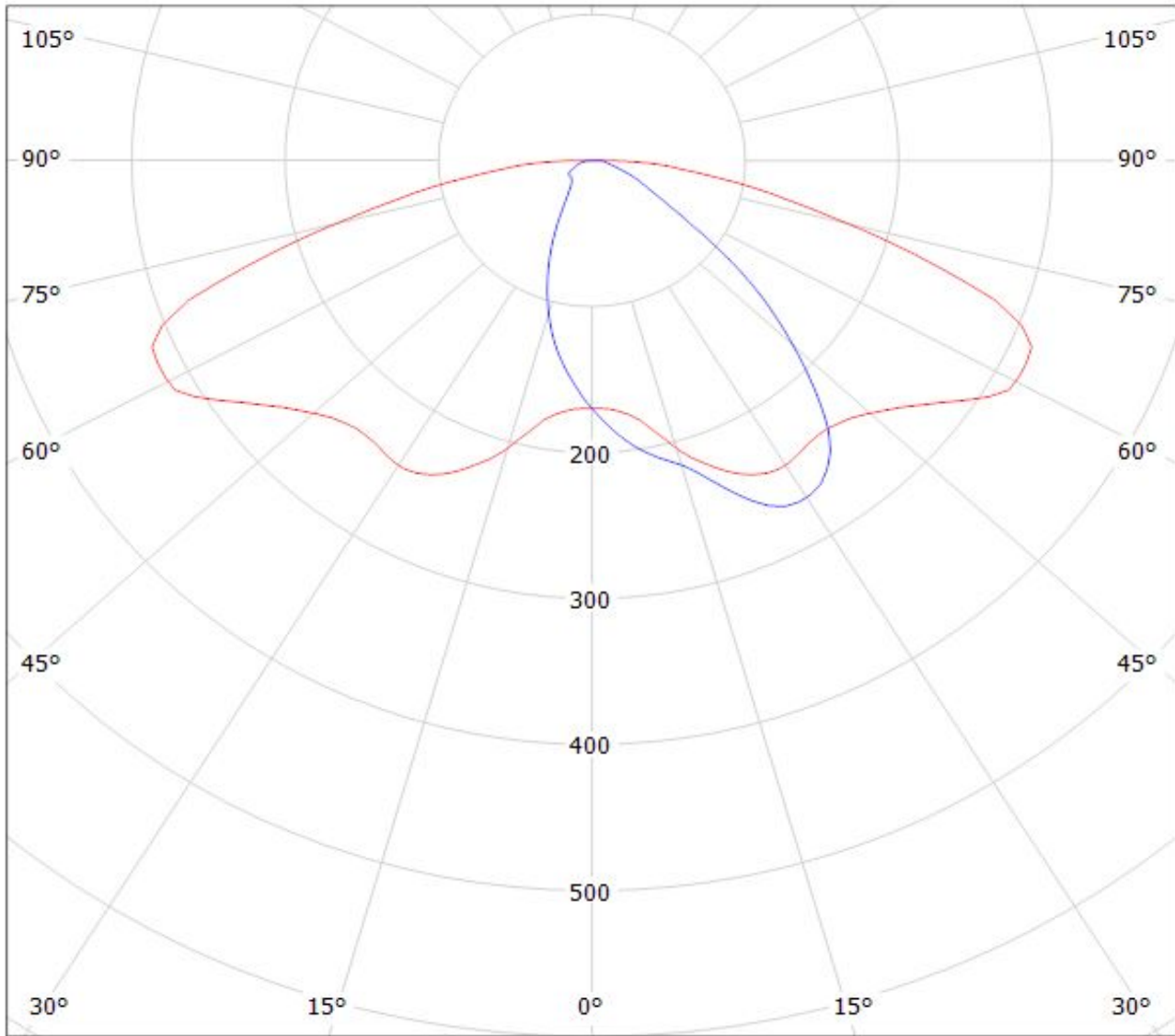

cd/klm

— C0 - C180 — C90 - C270

$\eta = 92\%$

Luminaire: Ledil Oy C12360_STRADA-2X2-DNW (XP-G) Efficiency=94%
Lamps: 1 x Cree XP-G 282lm @ 250mA

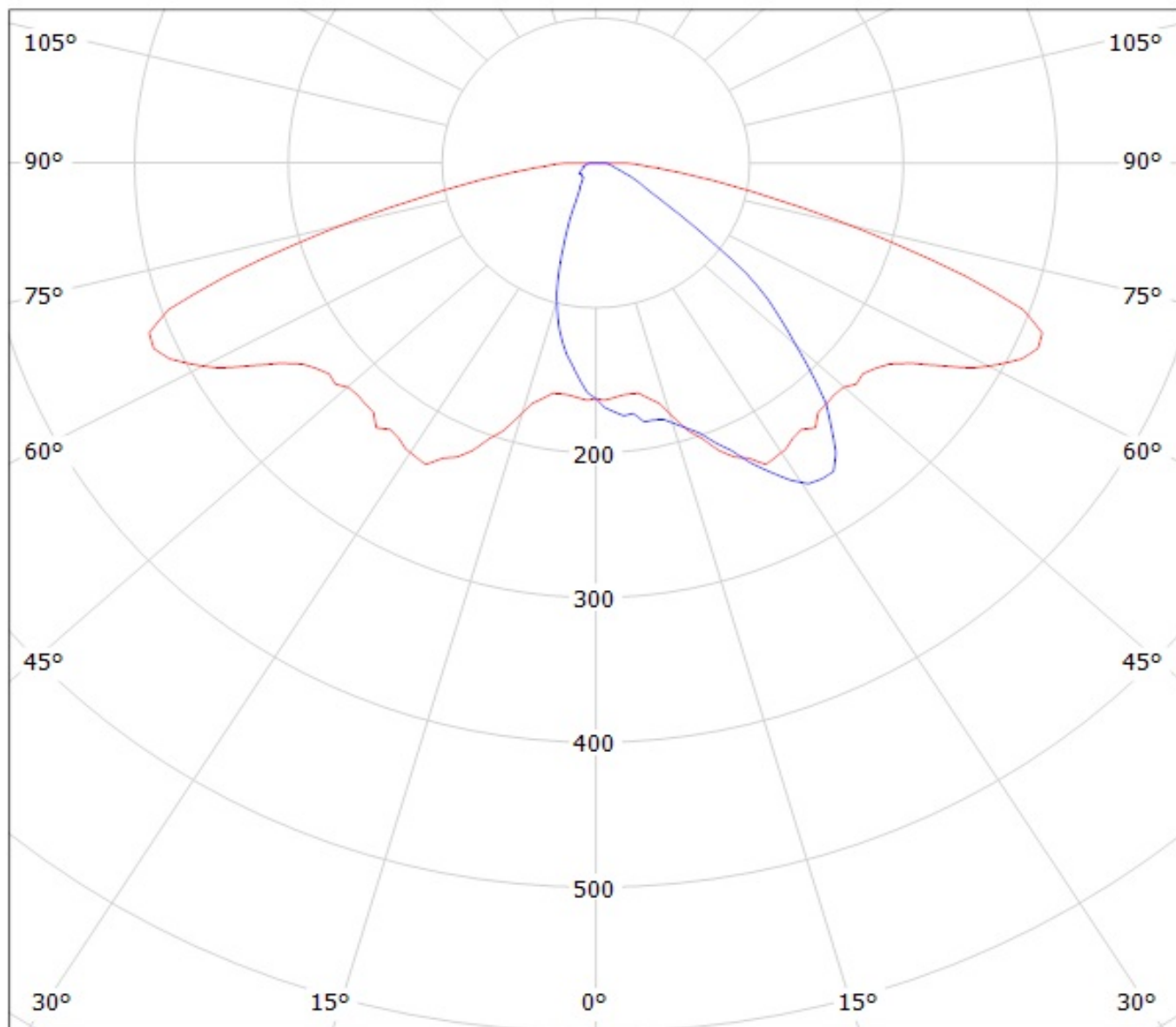

cd/klm

— C0 - C180 — C90 - C270

Luminaire: Ledil Oy C12360_Strada-2x2-DNW (XT-E) Efficiency=93%

Lamps: 1 x Cree XT-E 250mA 409lm

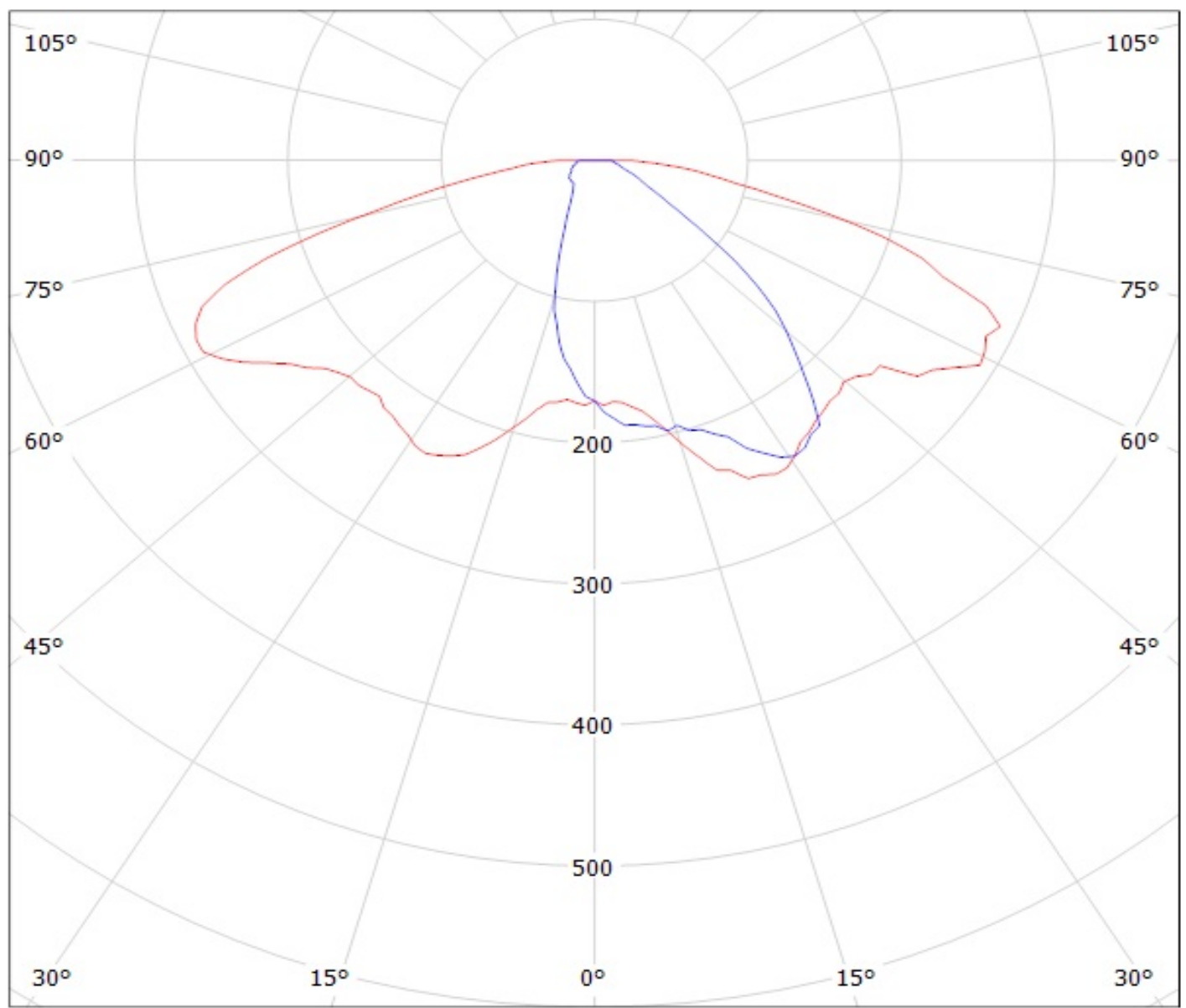

cd/klm
— C0 - C180 — C90 - C270

Luminaire: Ledil Oy C12360_STRADA-2X2-DNW (Cree XT-E (HVW) 1160lm @ 250mA) Efficiency=94%
Lamps: 1 x Cree XT-E (HVW) 1160lm @ 250mA

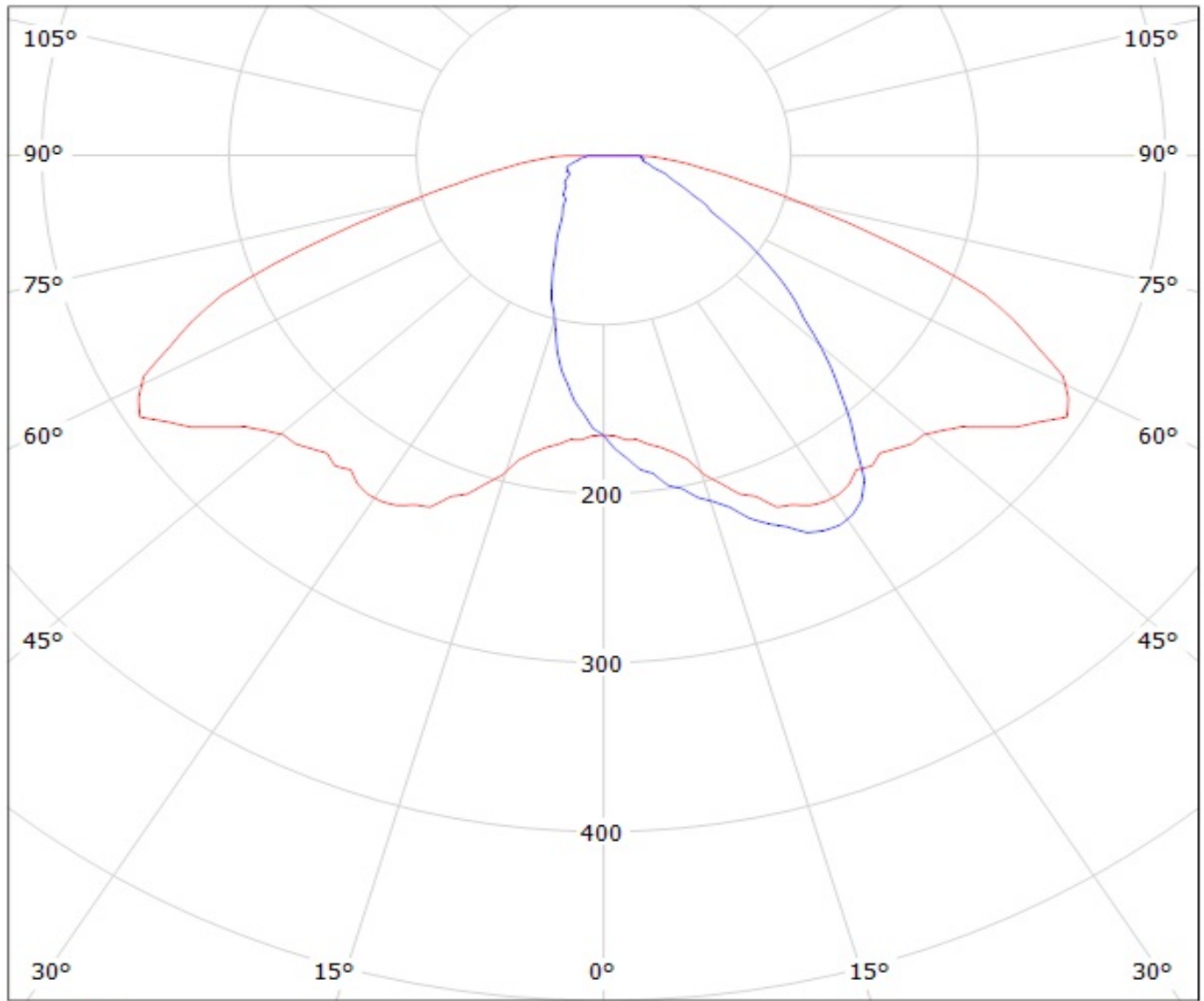

cd/klm

— C0 - C180

— C90 - C270

Luminaire: LEDil Oy C12360_STRADA-2X2-DNW_(XM-L2) Efficiency=94%
Lamps: 1 x Cree XM-L2 (XMLBWT-0-7B4-T30-0L-0001) 356lm @ 250mA CCT=3200K P=2.8W I=250mA

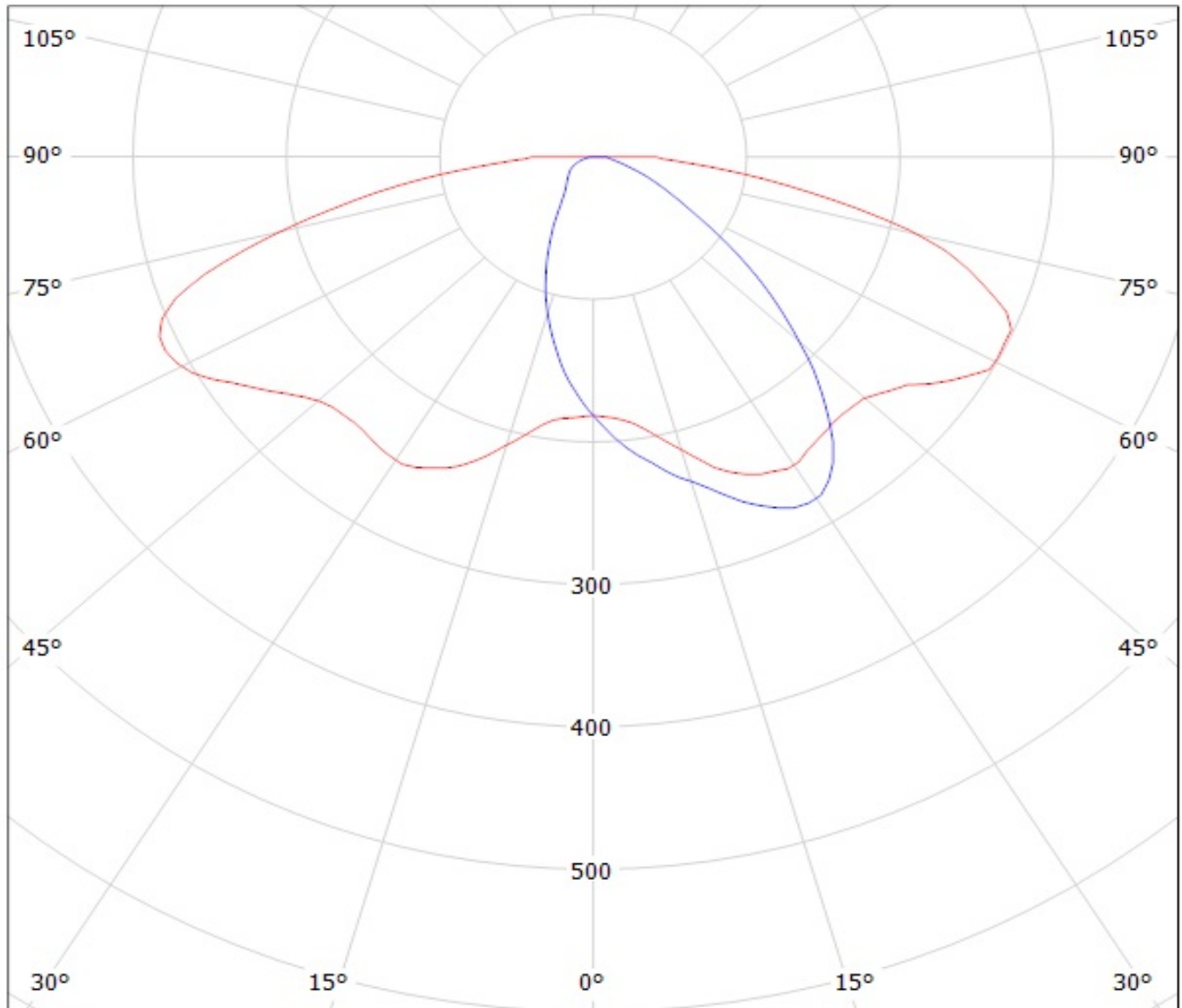

cd/klm

— C0 - C180 — C90 - C270

Luminaire: LEDil Oy C12360_STRADA-2X2-DNW_(XP-G2) Efficiency=94%
Lamps: 1 x CREE XP-G2 (XPGBWT-L1-000-00G51) 411lm @ 250mA CCT=7200K P=2.9W I=250mA

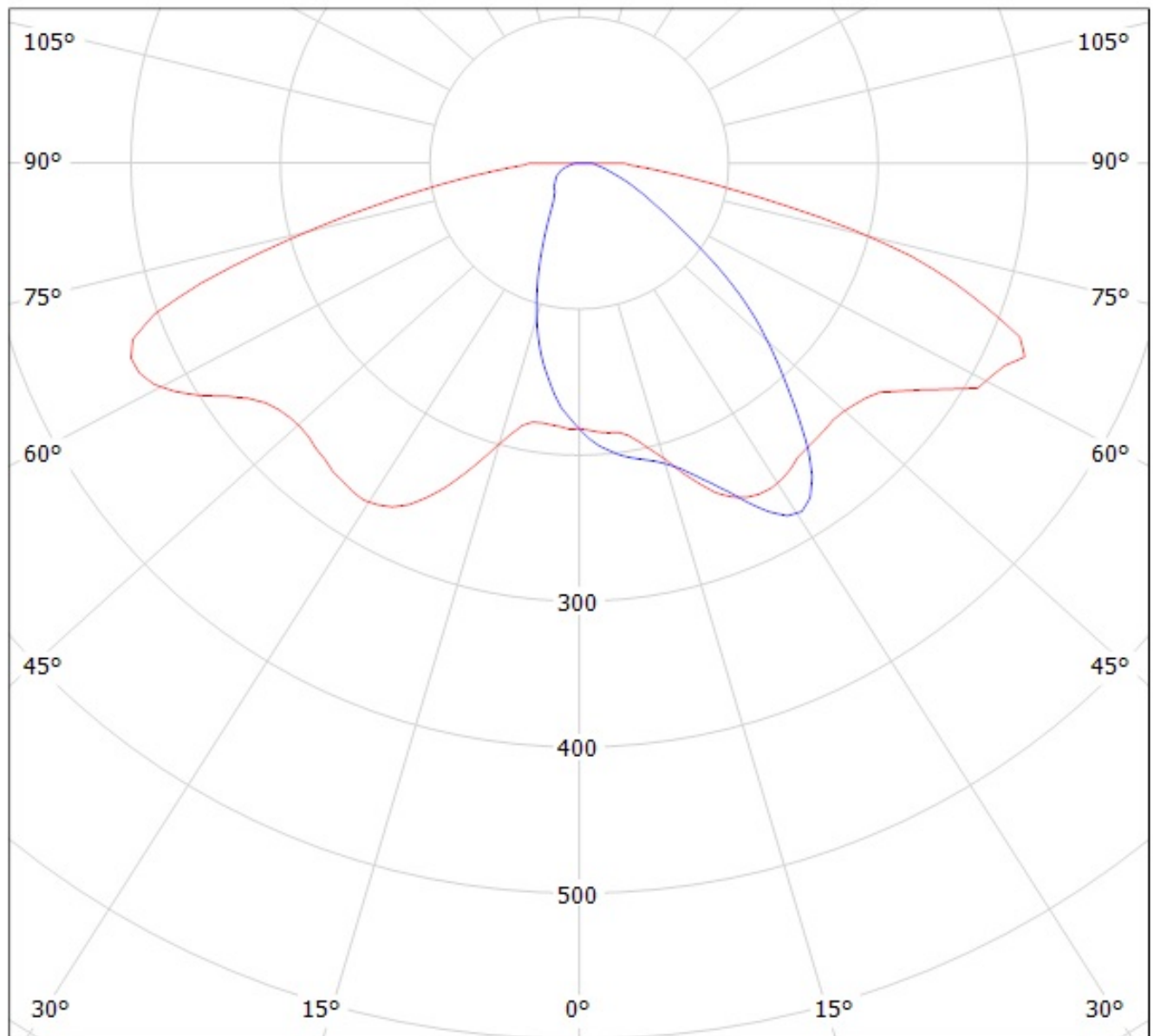

cd/klm

— C0 - C180 — C90 - C270

Luminaire: LEDiL Oy C12360_STRADA-2x2-DNW_(XP-L)

Lamps: 1 x CREE_XP-L_2x2_(XPLAWT-0-1B0-V40-00-0001)_510lm@250mA_CCT=7600K_P=2.79963W_I=249.9mA

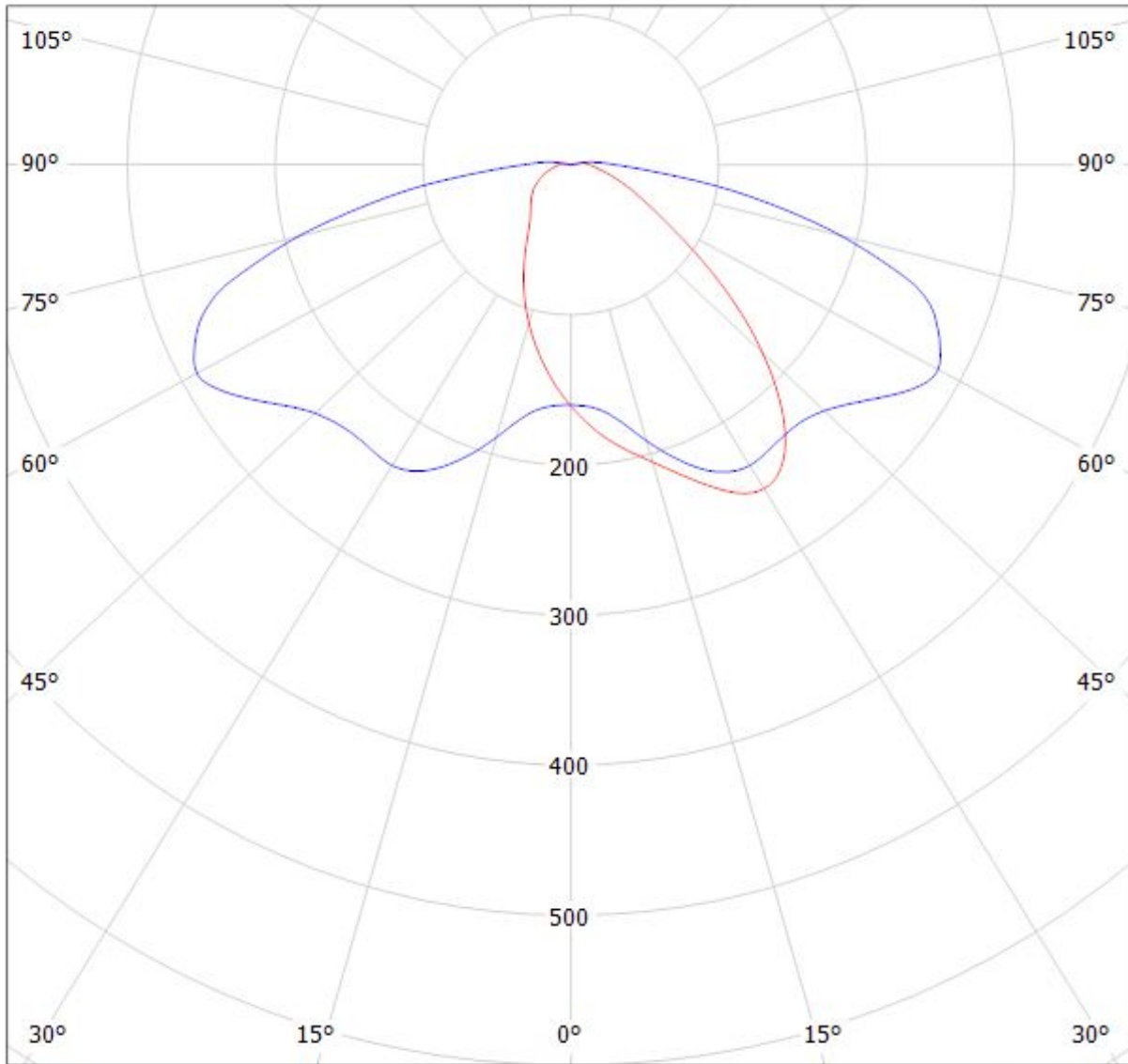

cd/klm

$\eta = 94\%$

— C0 - C180 — C90 - C270

Luminaire: LEDiL Oy C12360_STRADA-2X2-DNW_(XP-L_HI)

Lamps: 1 x Cree_XP-L_HI_(2x2)_(XPLAWT-H-5A3-U60-013-0001)_455.077lm@250mA_P=2.84011W_I=0,2499A

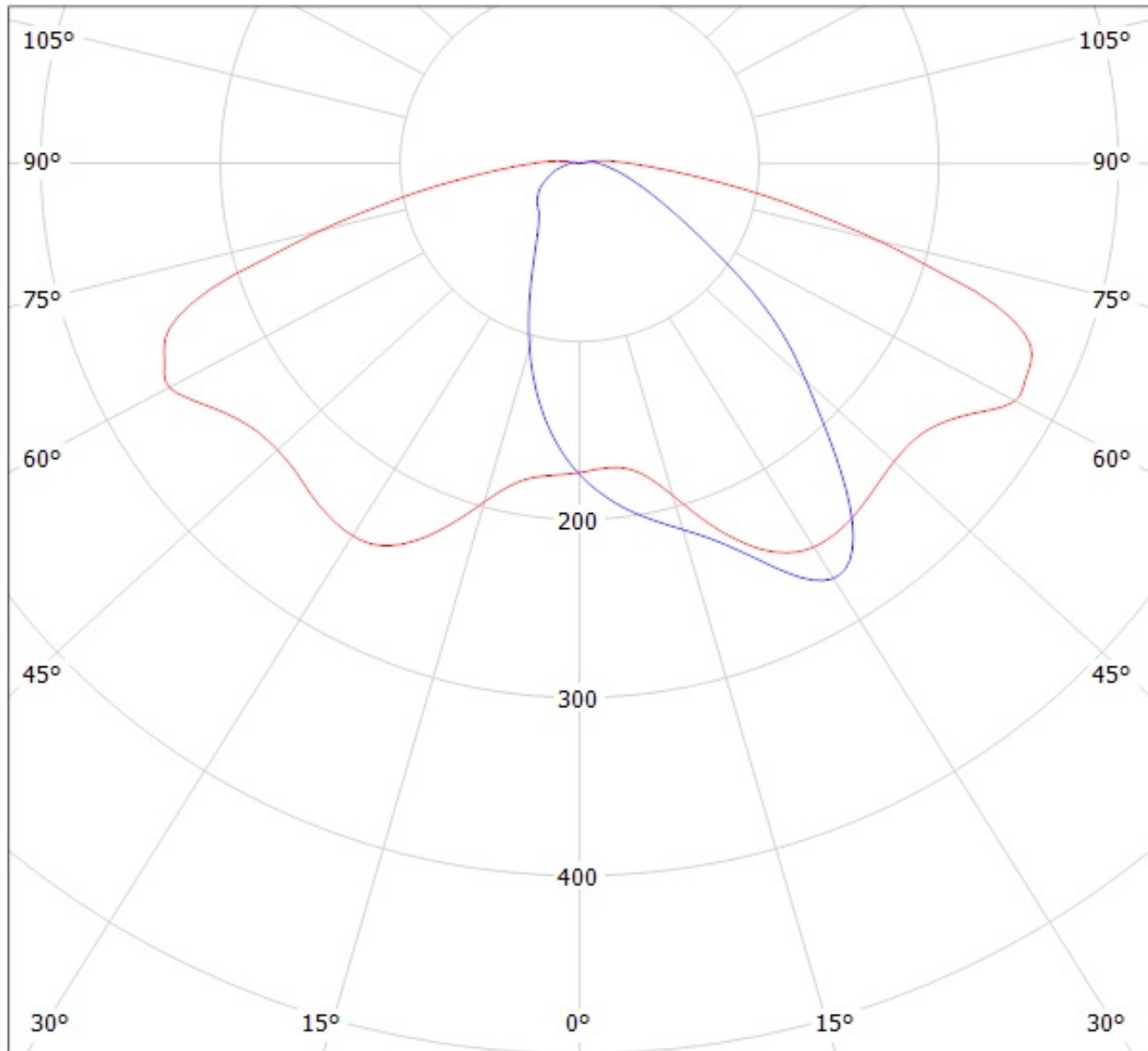

cd/klm

— C0 - C180

— C90 - C270

$\eta = 94\%$

Luminaire: Ledil Oy C12360_STRADA-2X2-DNW_(XP-G3)_SIMULATED
Lamps: 1 x Cree XP-G3

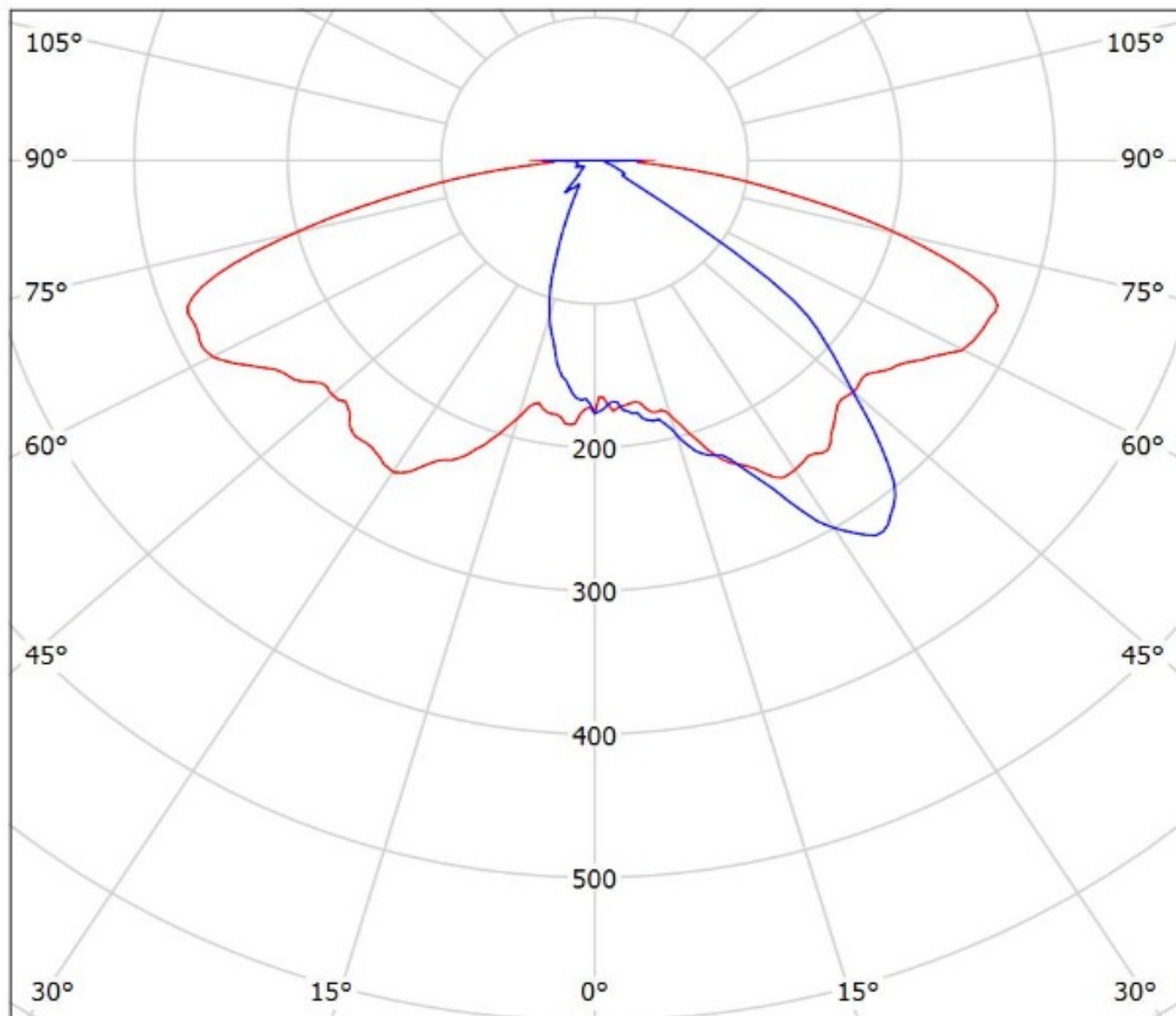

cd/klm

— C0 - C180 — C90 - C270

$\eta = 94\%$

Luminaire: Ledil C12360_STRADA-2X2-DNW_(XP-L2)

Lamps: 1 x Cree_XP-L2_2x2_(XPLBWT-00-0000-000BV50E3)550.93lm@250mA_P=2.7815W_I=0.25A

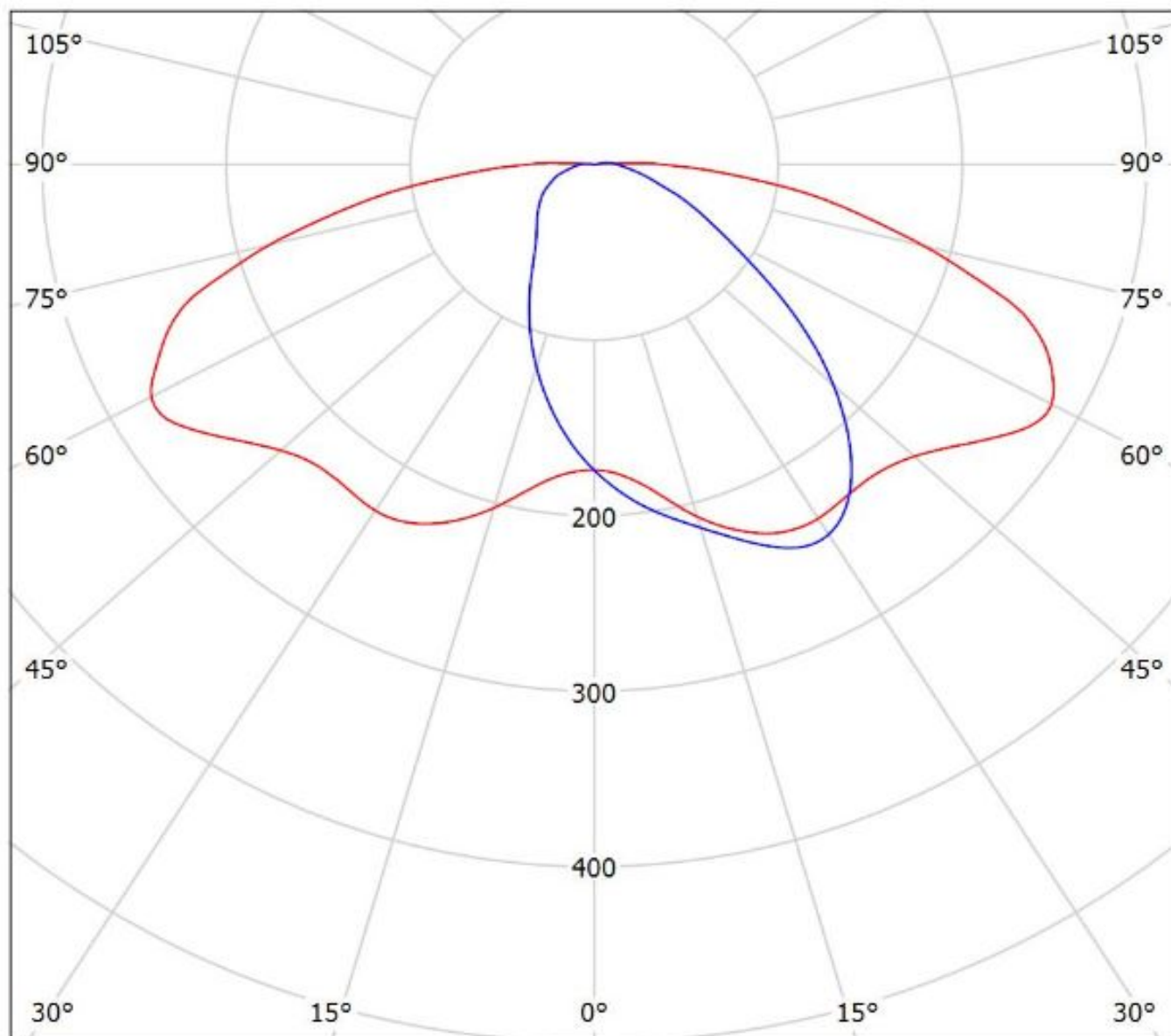

cd/klm

— C0 - C180 — C90 - C270

η = 95%

Luminaire: LEDiL Oy C12360_Strada-2x2-DNW_(LG3535) Eff. 93,5%
Lamps: 1 x LG Ceramic 3535 PKG (372lm@250mA)

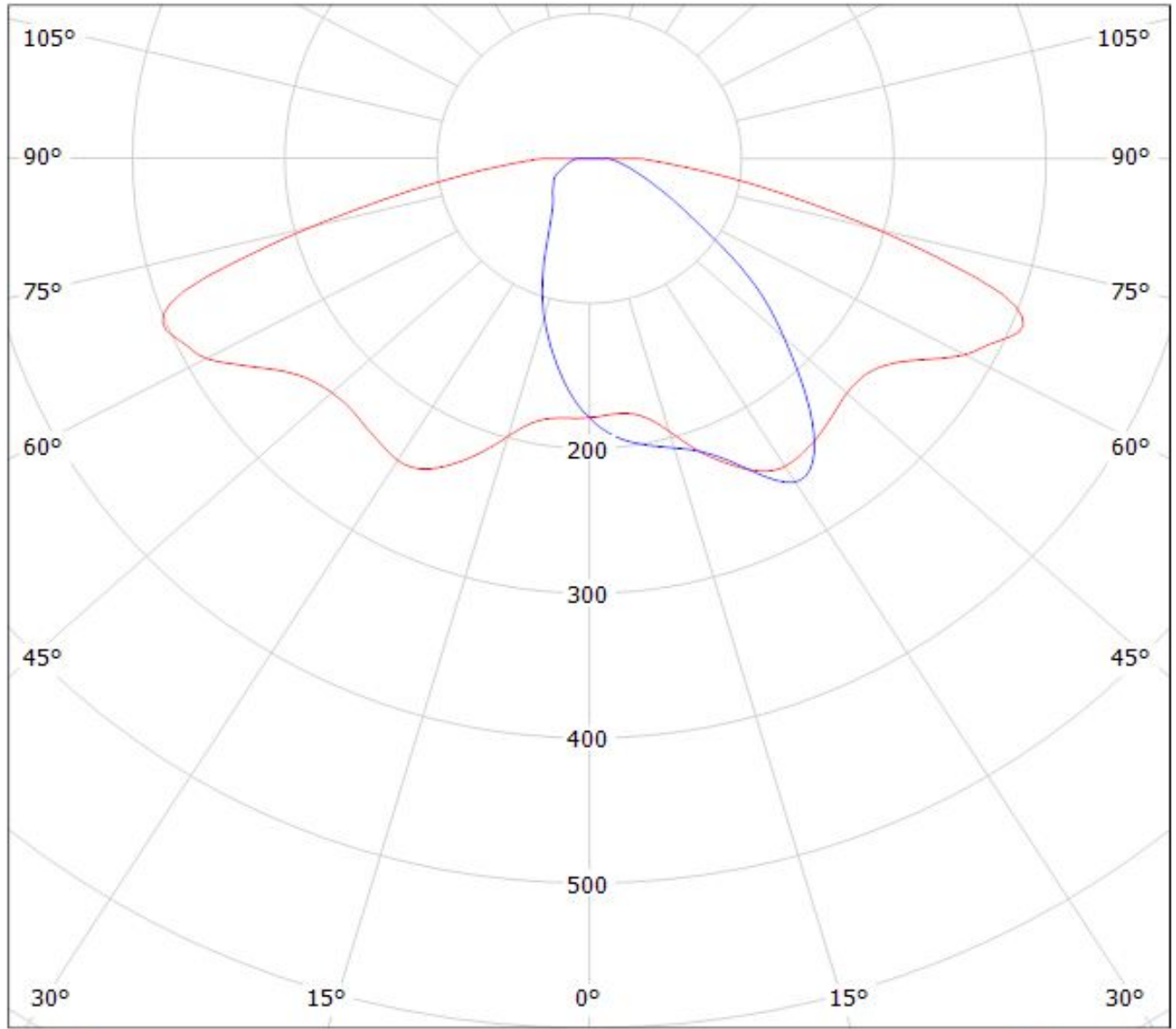

cd/klm
— C0 - C180 — C90 - C270

$\eta = 94\%$

Luminaire: Ledil Oy C12360_STRADA-2X2-DNW-RE-ES Efficiency=93%
Lamps: 1 x Luxeon Rebel ES 250mA 366lm

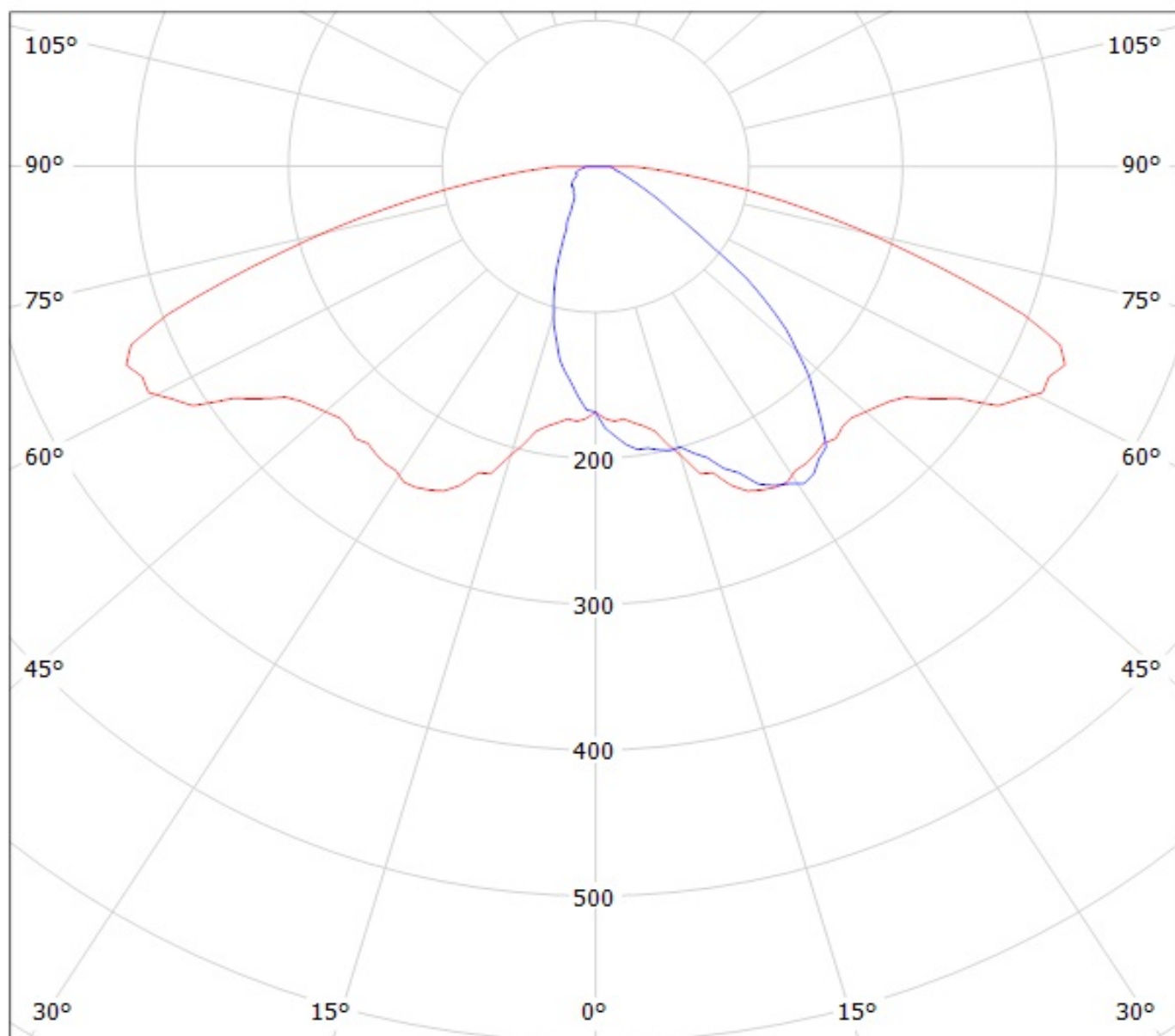

cd/klm

— C0 - C180 — C90 - C270

Luminaire: LEDiL Oy C12360_Strada_2x2_DNW_(LUXEON_T) Eff.92.5%
Lamps: 1 x LUXEON_T 2x2 (294lm@250mA)

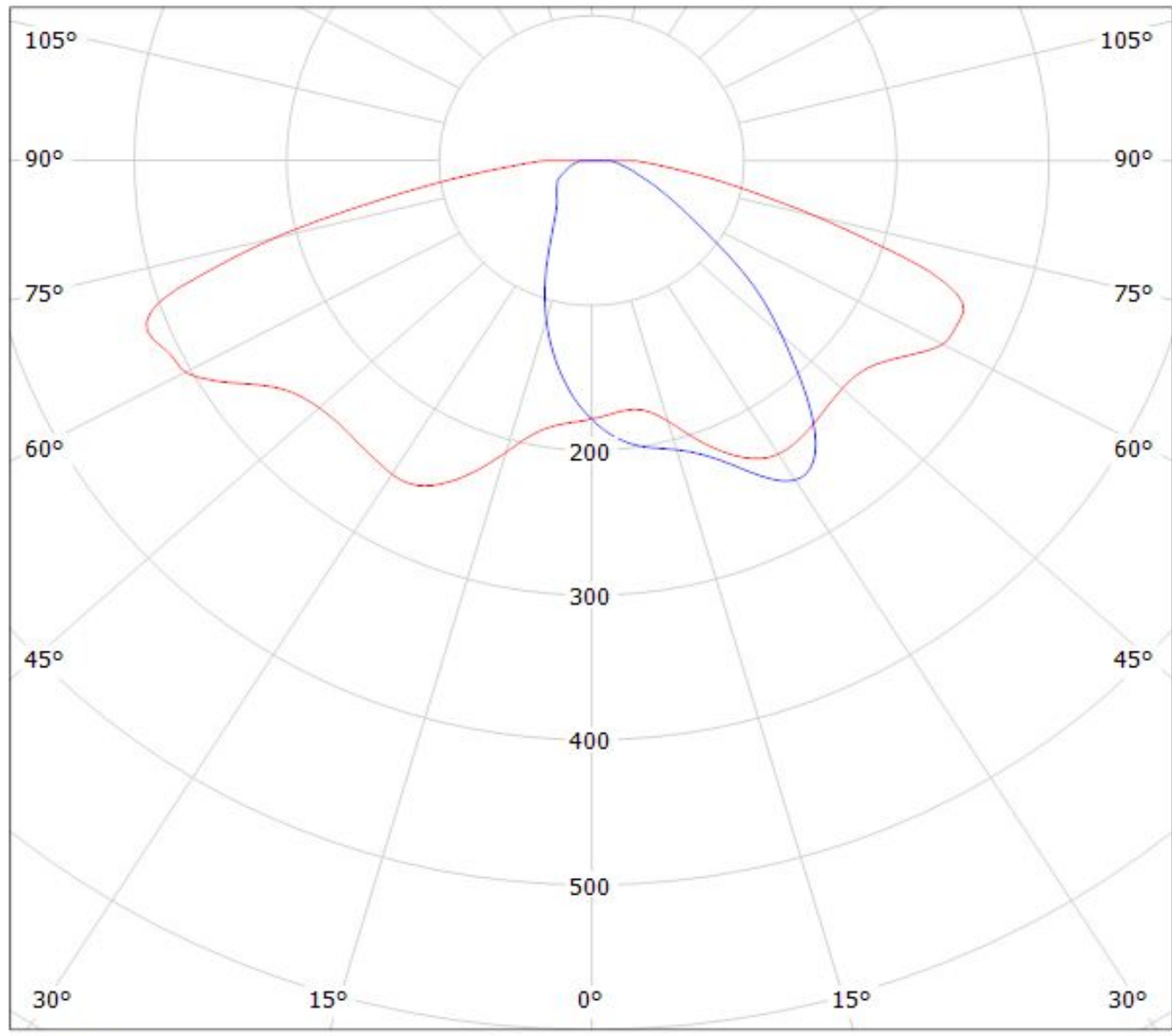

cd/klm
— C0 - C180 — C90 - C270

$\eta = 92\%$

Luminaire: LEDiL Oy C12360_STRADA-2X2-DNW_(Luxeon-Z-ES) Eff: 94%
Lamps: 1 x Luxeon Z ES 2x2 (LXZ2-3090) 209.277lm@250mA_P=2.81W_I=0.2499A

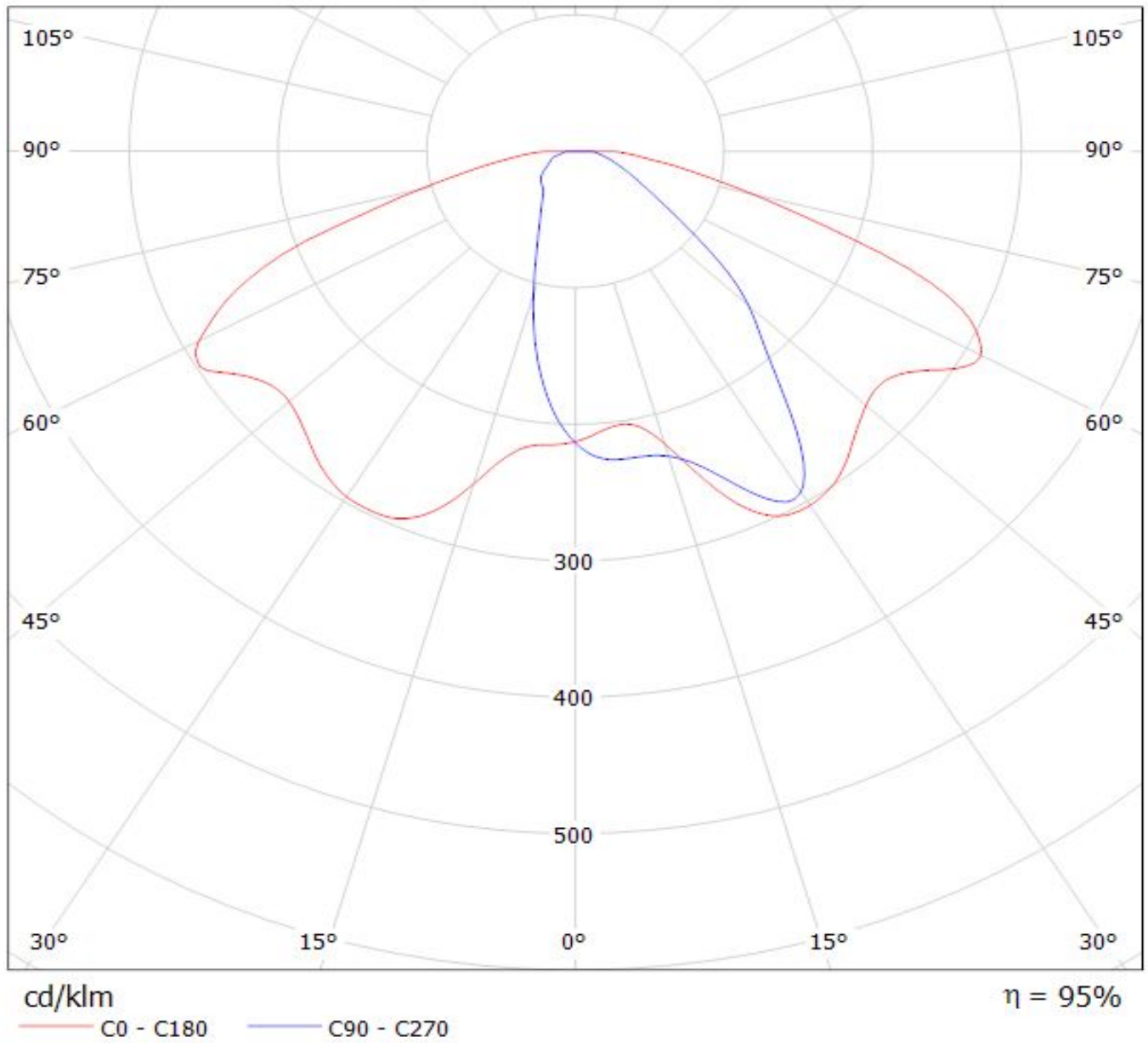

Luminaire: LEDiL Oy C12360_STRADA-2X2-DNW_(LUXEON_Q) Eff.93.7%

Lamps: 1 x LUXEON_Q_2x2_(LHQ-3080)_299.038lm@250mA_P=2.8742W_I=249.8mA

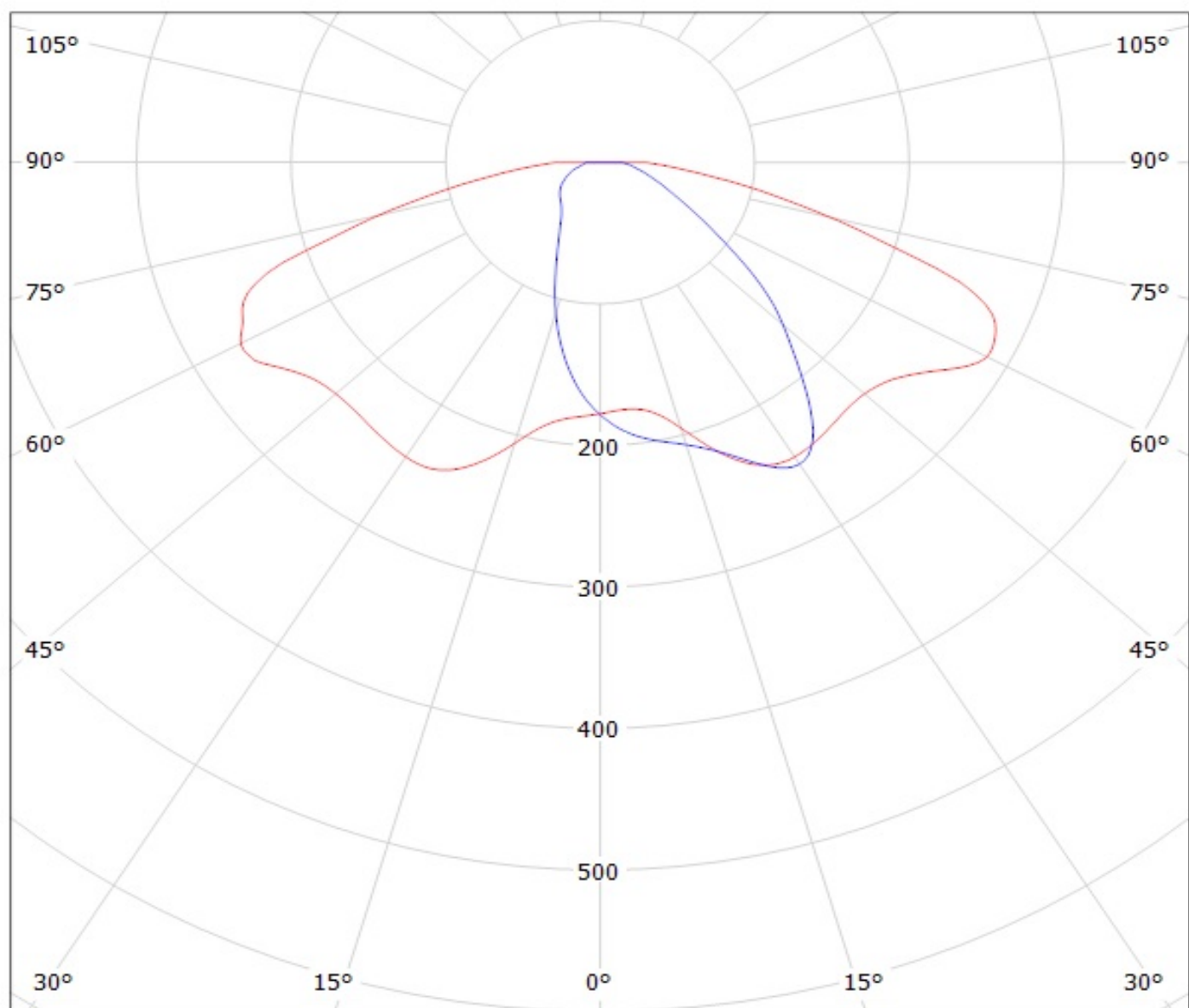

cd/klm

— C0 - C180

— C90 - C270

η = 94%

Luminaire: LEDiL Oy C12360_STRADA-2X2-DNW_(Luxeon_TX)
Lamps: 1 x Luxeon_TX_2x2_321.384lm@250mA_P=2.79488W_I=249.9mA

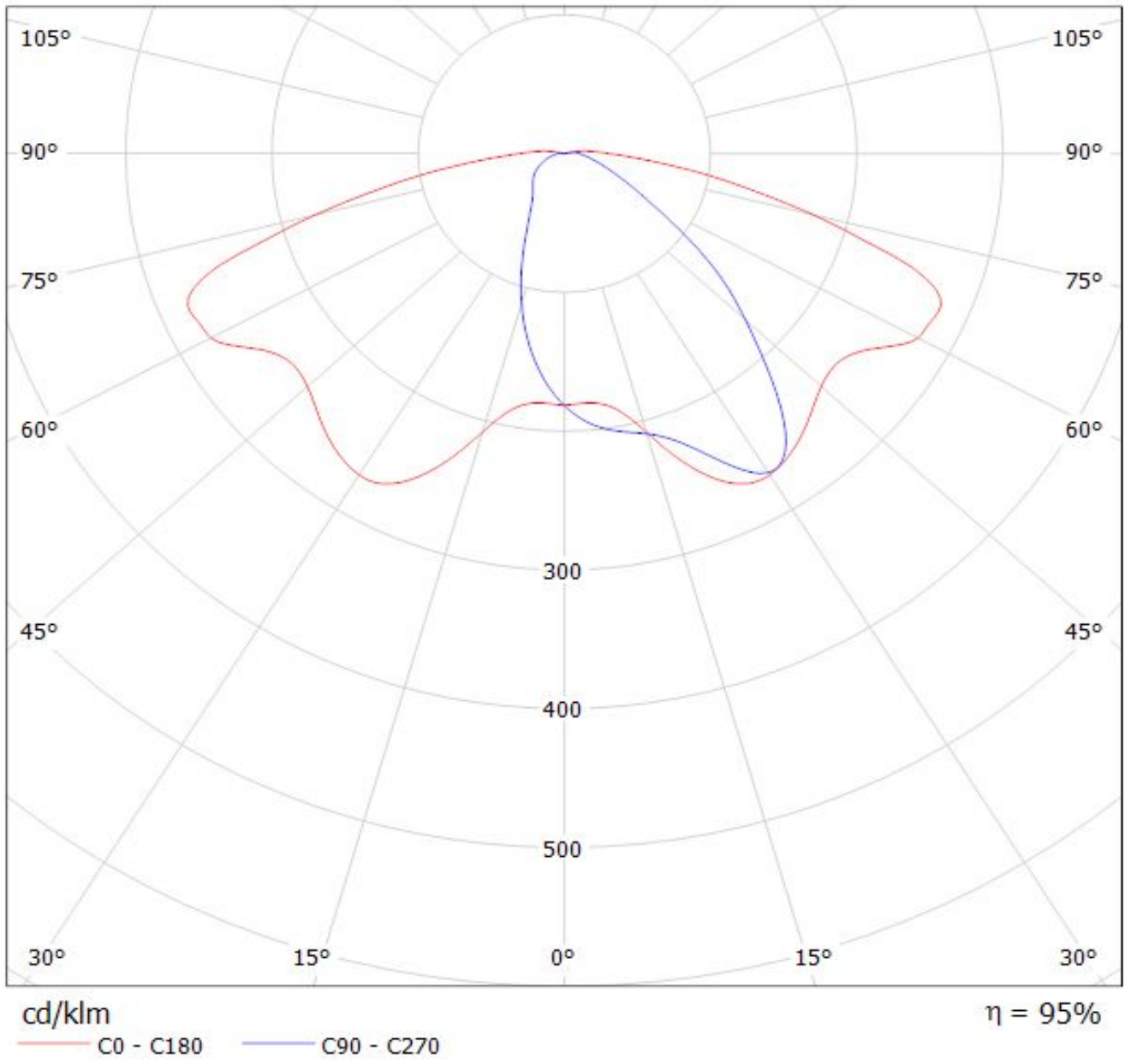

Luminaire: Ledil C12360_STRADA-2X2-DNW_(Luxeon_MZ)

Lamps: 1 x Philips_Lumileds_Luxeon_MZ_(LMZ7-QW57)_(2x2)_427.268lm@250mA_P=2.734W_I=0.2500A

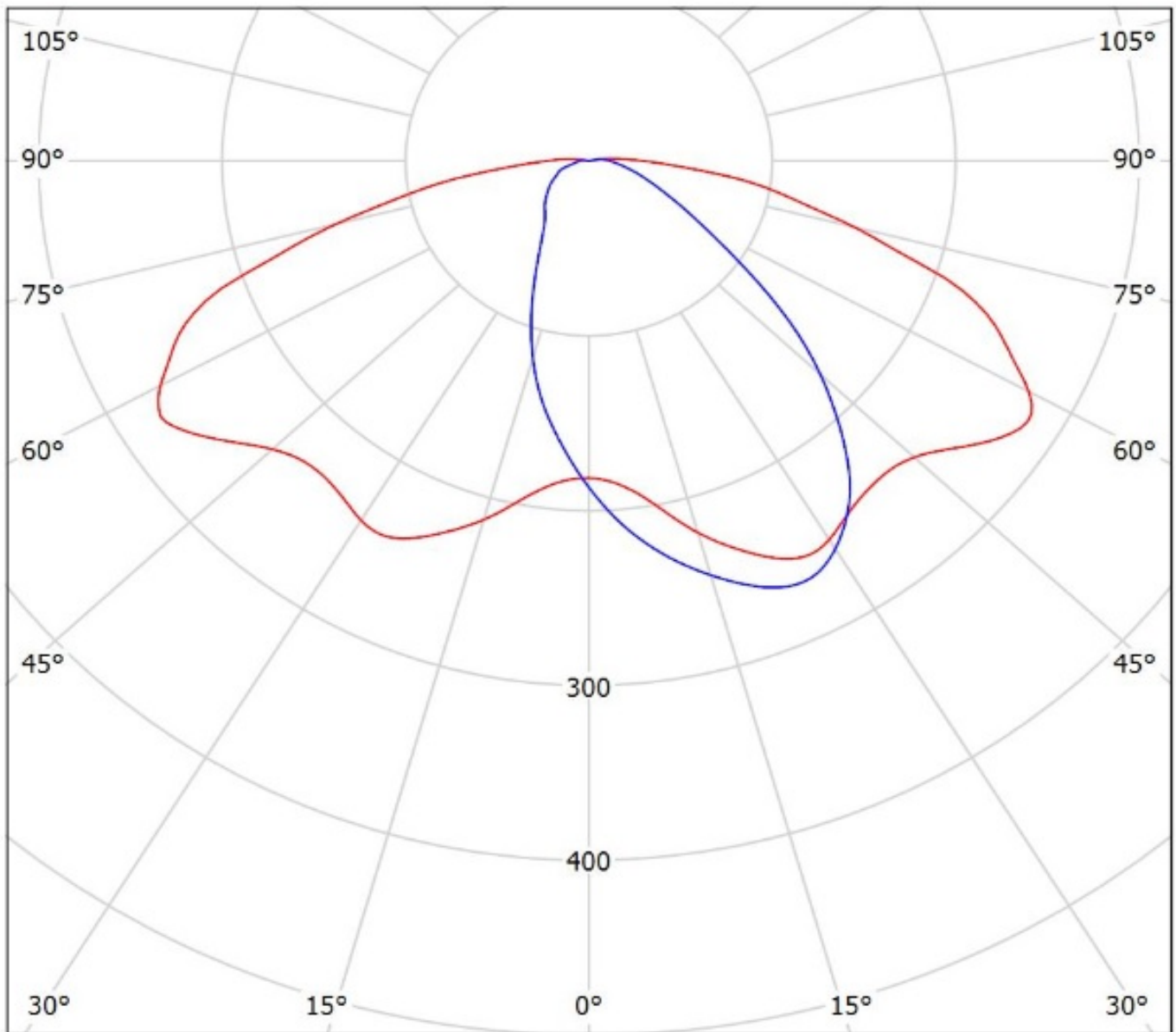

cd/klm

— C0 - C180 — C90 - C270

$\eta = 95\%$

Luminaire: LEDiL Oy C12360_STRADA-2X2-DNW_(E21A)
Lamps: 1 x Nichia_E21A_452.248lm@250mA_2.805W_η=0.250A

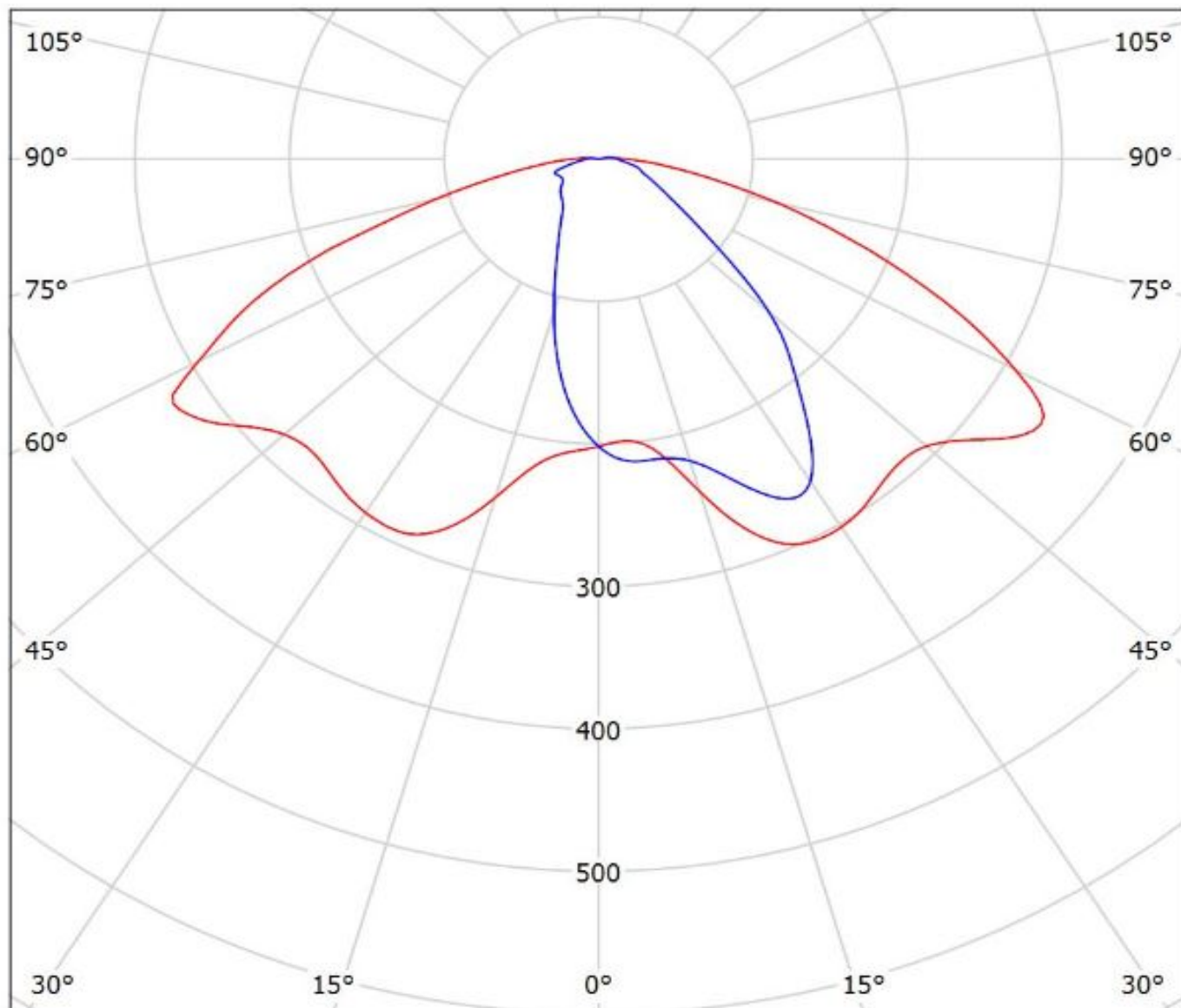

cd/klm
— C0 - C180 — C90 - C270

η = 94%

Luminaire: LEDiL Oy C12360_STRADA-2X2-DNW_(NVSW319AE)
Lamps: 1 x Nichia_NVSW319AE_499.093lm@250mA_P=2.79052W_I=0.25A

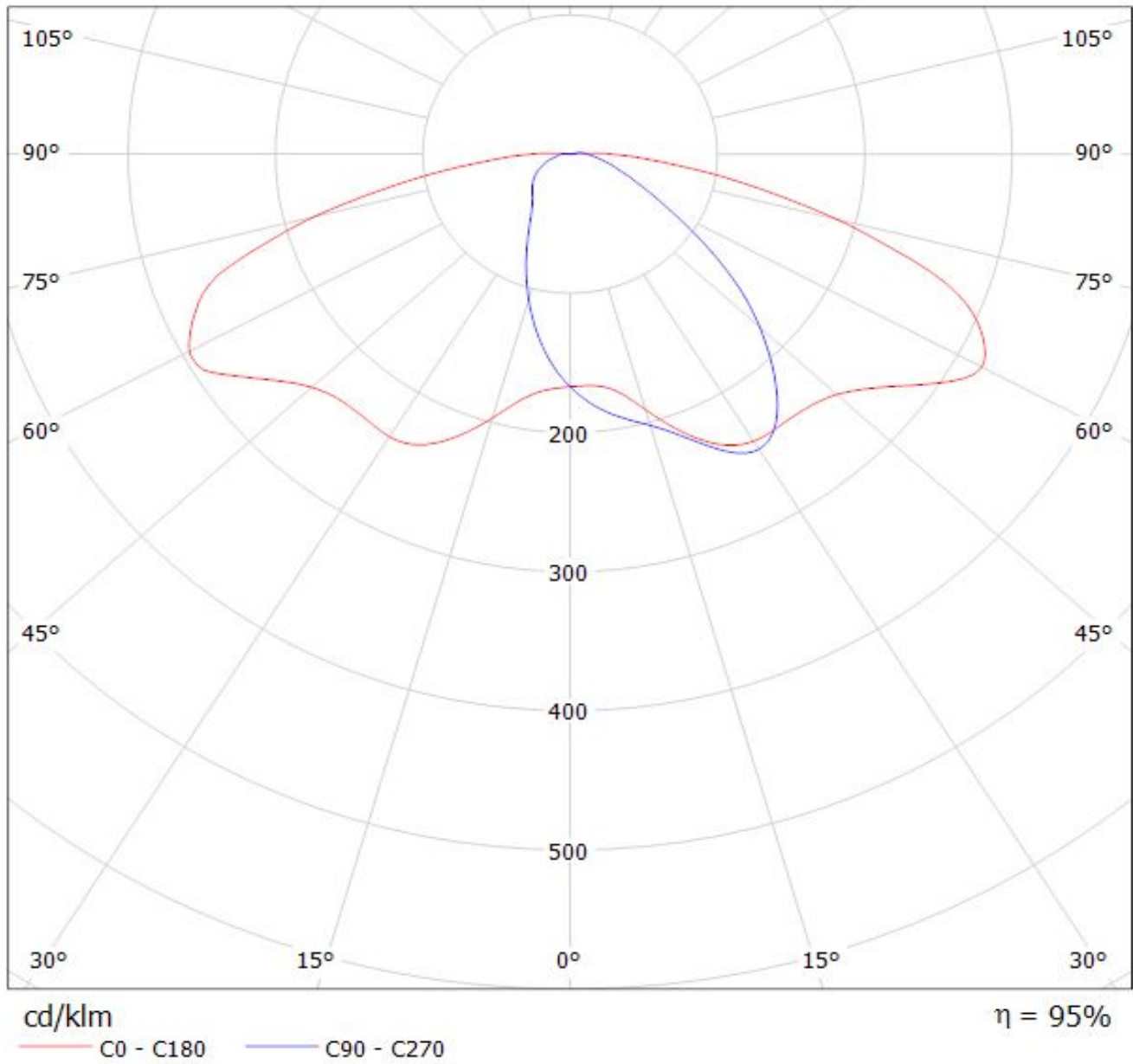

Luminaire: Ledil Oy C11918_STRADA-T-6X1-DNW (Osram Square PC 398lm @ 250mA) Efficiency=93%
Lamps: 1 x Osram Square PC 398lm @ 250mA

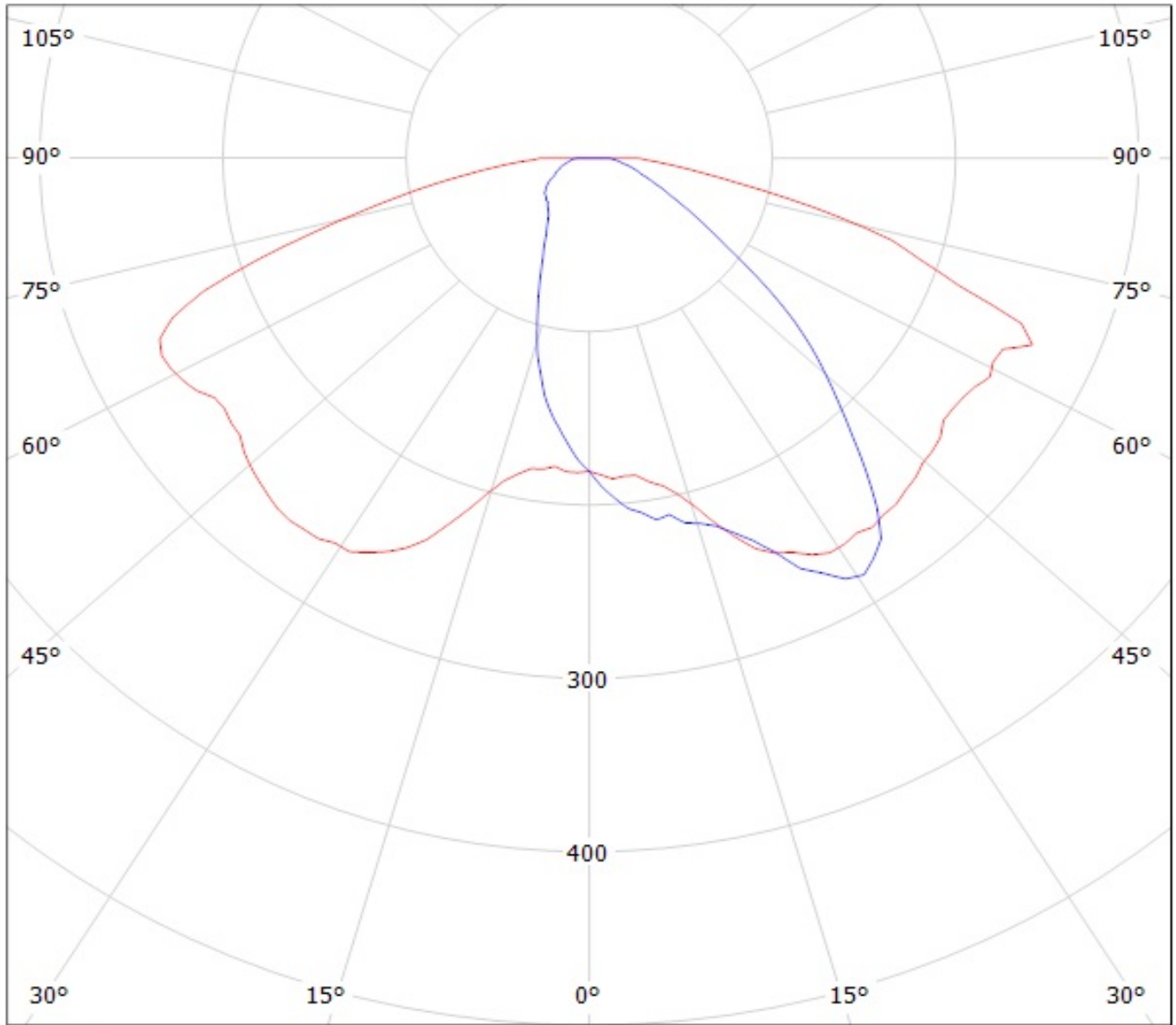

cd/klm

— C0 - C180

— C90 - C270

Luminaire: Ledil C12360_STRADA-2X2-DNW(square_gen3)

Lamps: 1 x Osram_square_gen3_2x2_(GW_CSSRM2.PM)_460.271lm@250mA_CCT=5000K_P=2.80625W_I=0.25A

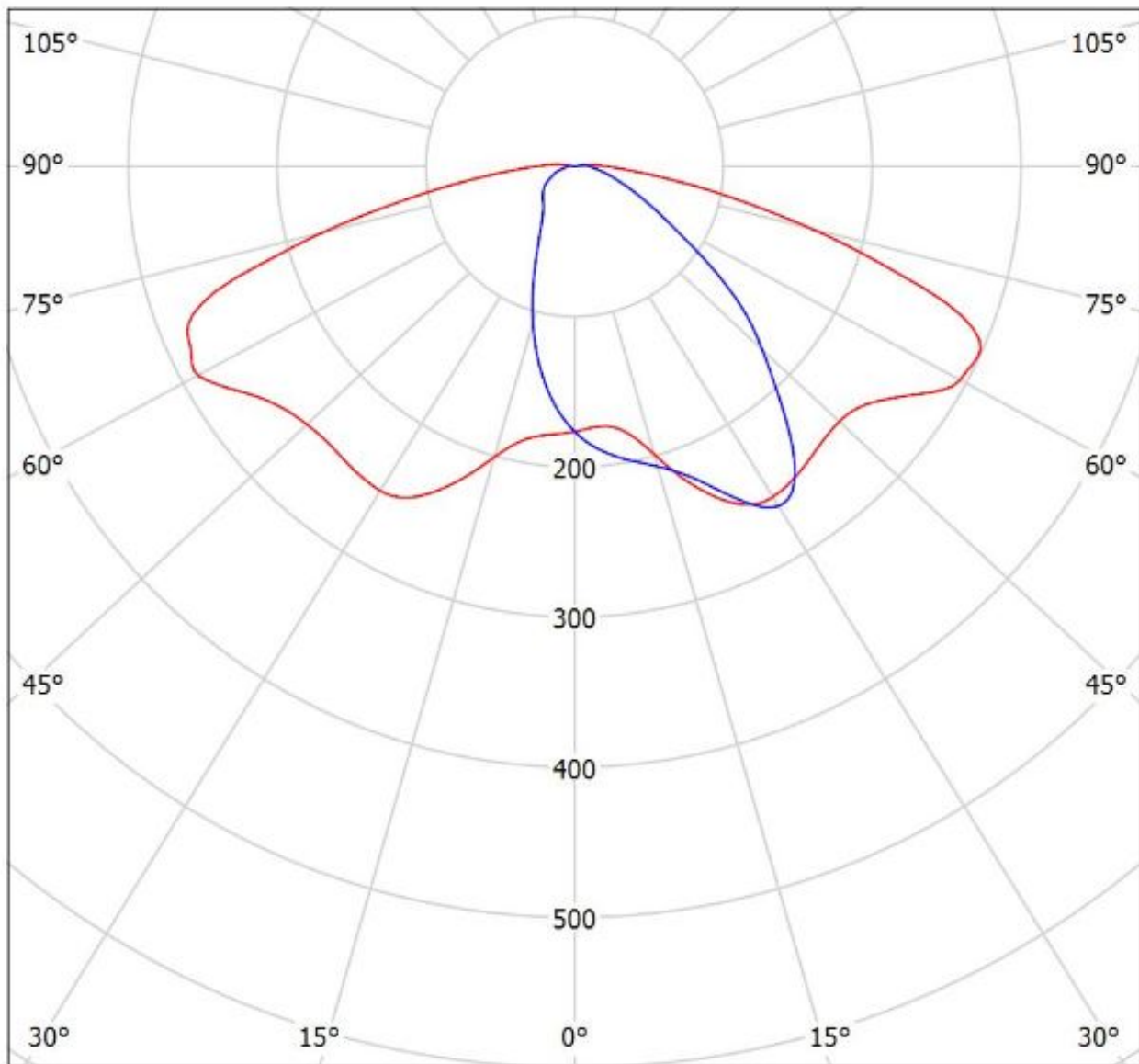

cd/klm

— C0 - C180 — C90 - C270

$\eta = 94\%$

Luminaire: Ledil Oy C12362_STRADA-2X2-DWC_(Duris_P8)_SIMULATED
Lamps: 1 x Osram Duris P8

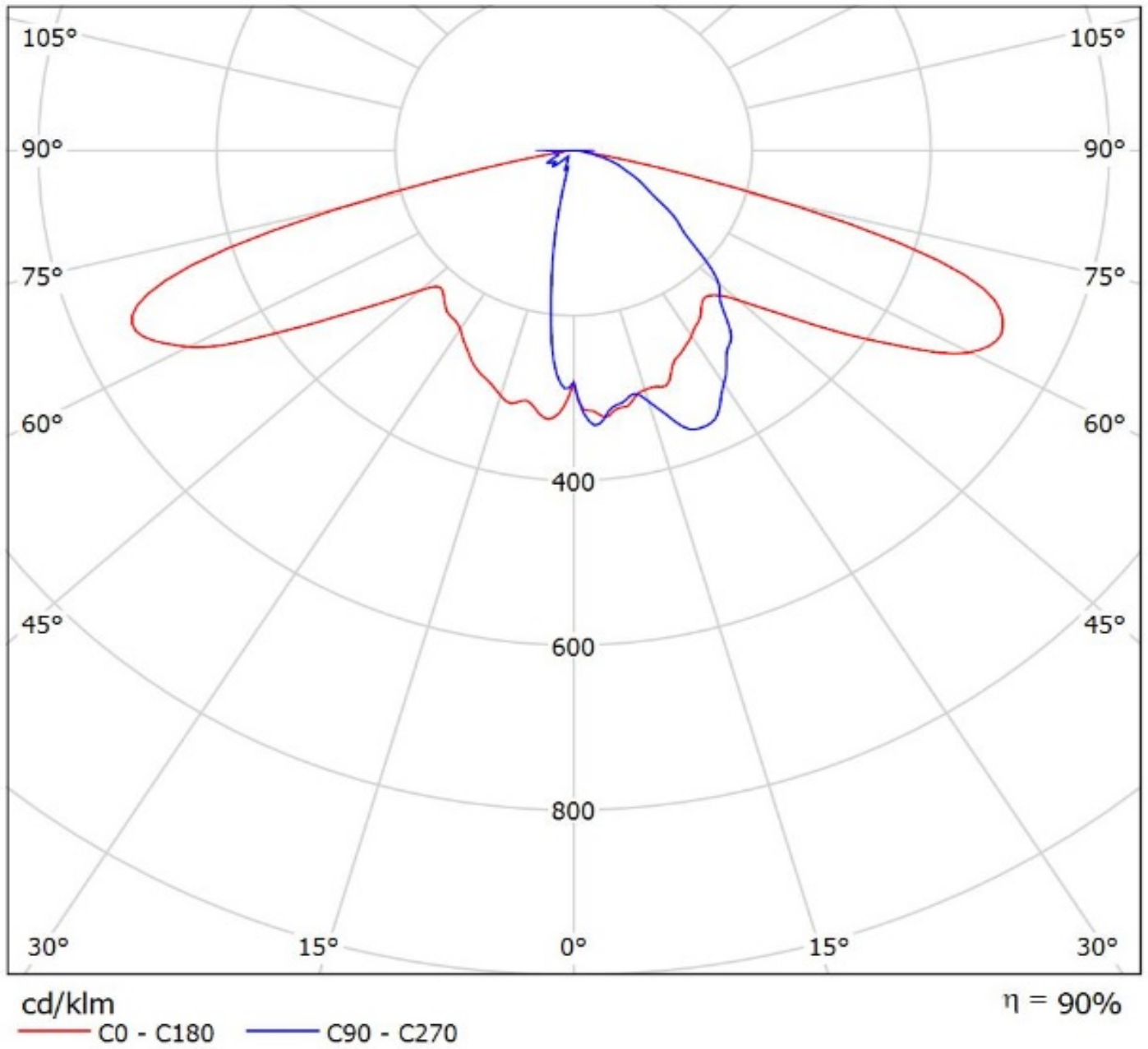

Luminaire: LEDiL Oy C12360_STRADA-2X2-DNW_(Fortimo_F-Flex_2x8_740DAG3)

Lamps: 1 x Philips_Fortimo_FastFlex_LED_board_2x8/740_DA_G3_1795.7lm@250mA_P=11.6015W_I=0.2498A

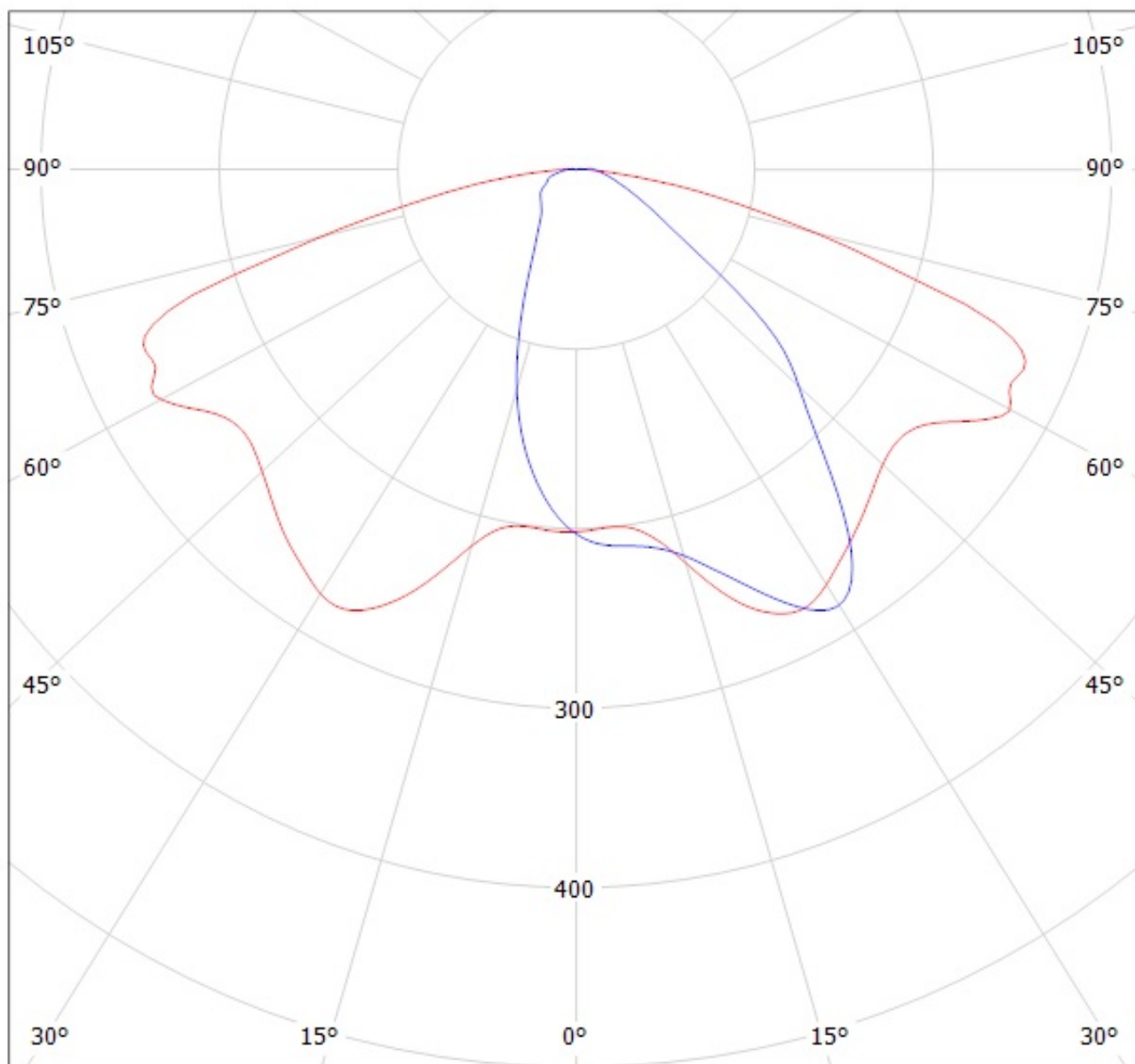

cd/klm

— C0 - C180 — C90 - C270

$\eta = 95\%$

Luminaire: LEDiL Oy C12360_STRADA-2X2-DNW_(LH351B)

Lamps: 1 x SAMSUNG_LH351B_2x2_437.85lm@250mA_P=2.84311W_I=249.9mA

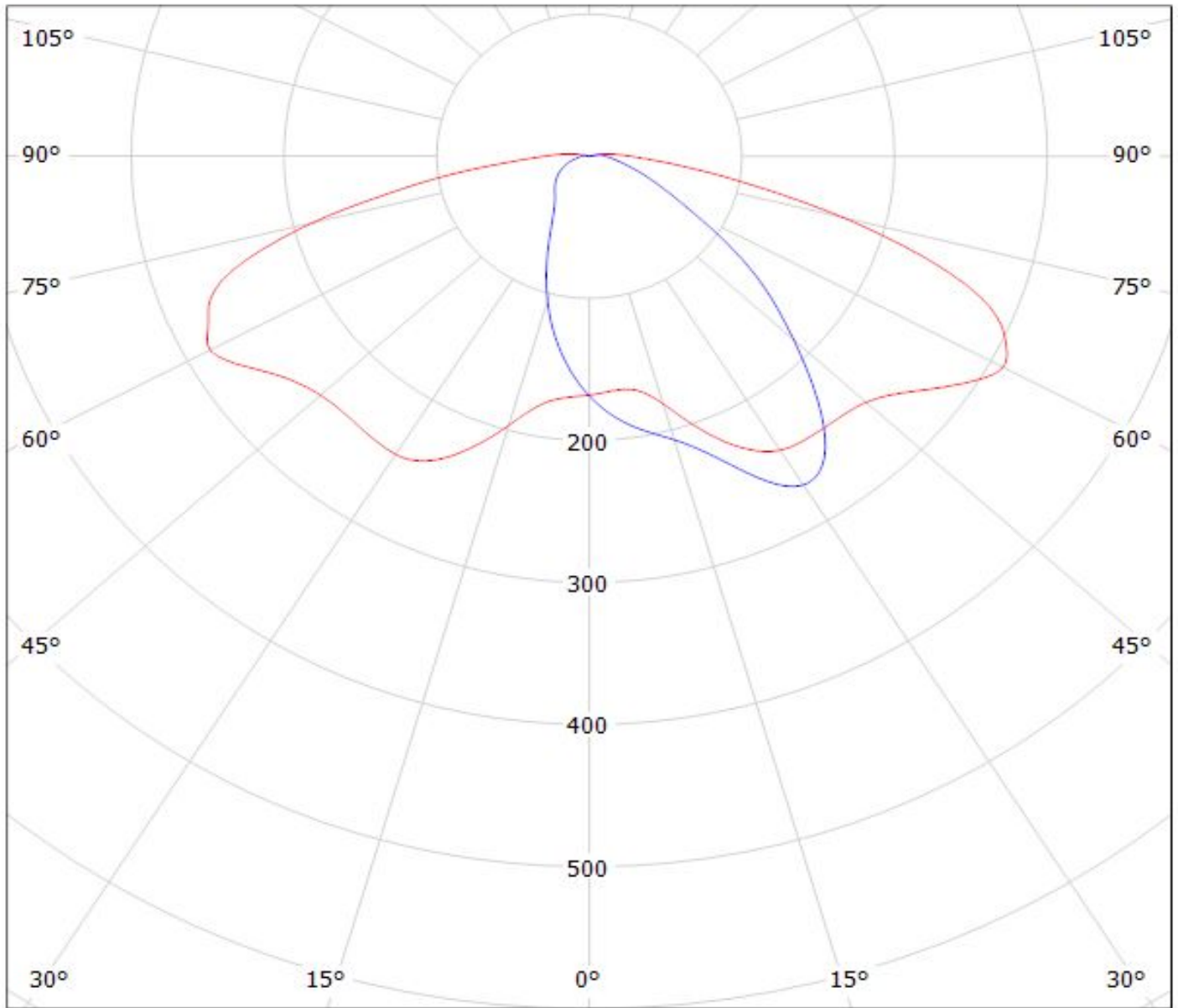

cd/klm

— C0 - C180

— C90 - C270

$\eta = 94\%$

Luminaire: LEDiL Oy C12360_STRADA-2X2-DNW_(LH351Z) Eff: 94%
Lamps: 1 x SAMSUNG_LH351Z_2x2_364.45lm@250mA_P=2.86596W_I=249.8mA

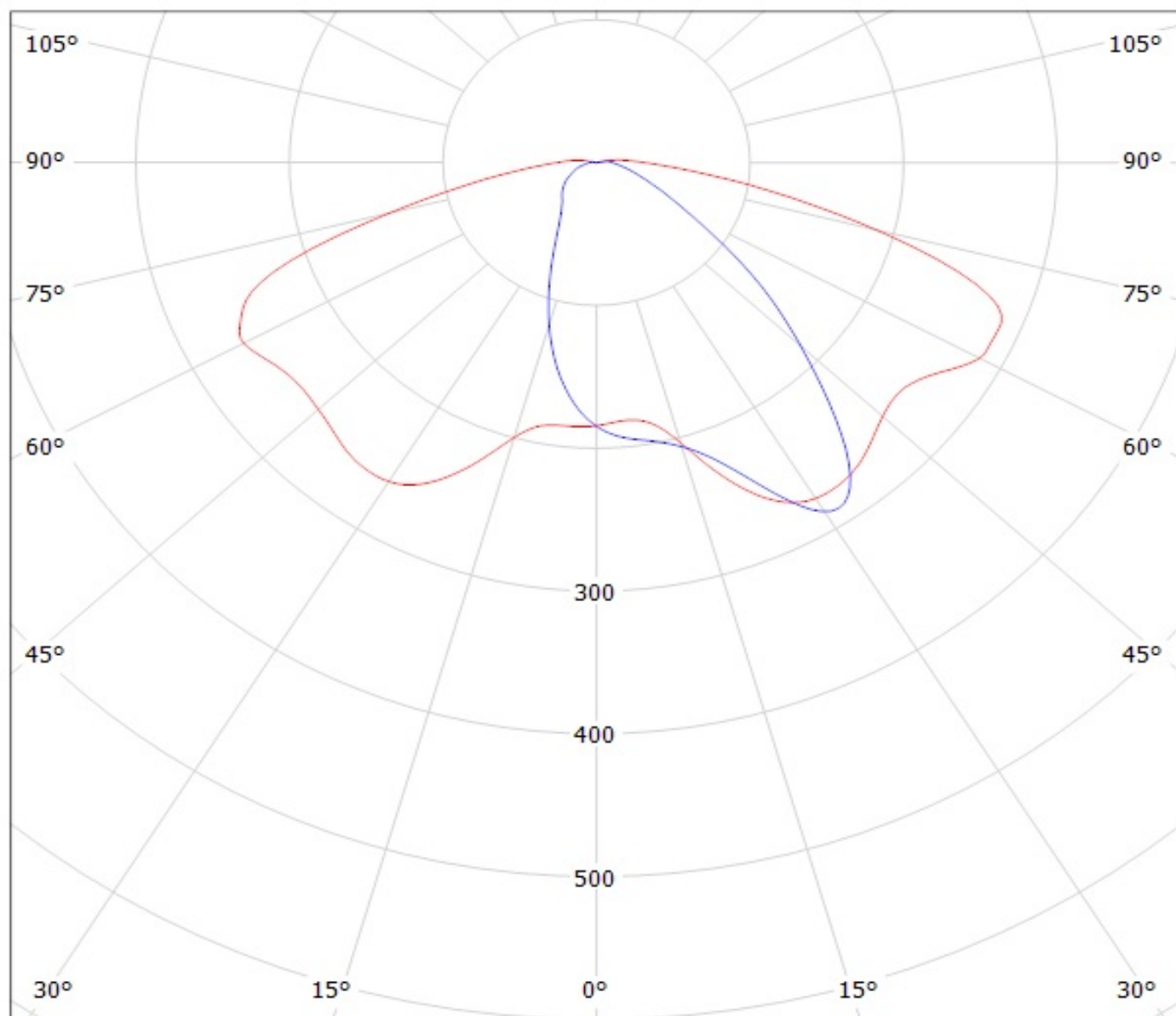

cd/klm

— C0 - C180 — C90 - C270

Luminaire: Ledil C12360_STRADA-2X2-DNW_(LH351D)
Lamps: 1 x Samsung_LH351D_536.957lm@250mA_P=2.7695W_I=0.250A

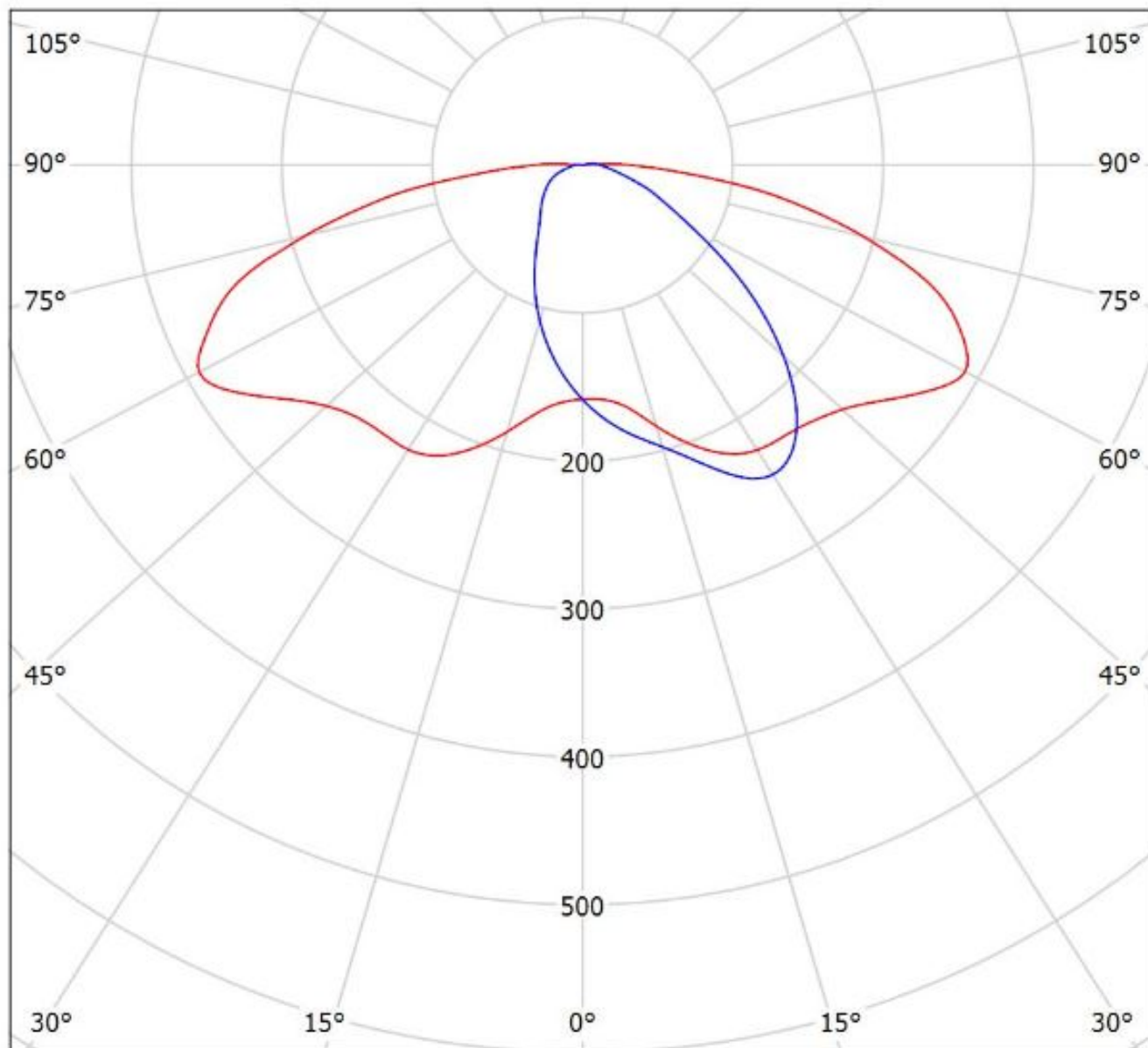

cd/klm

— C0 - C180 — C90 - C270

$\eta = 94\%$

LEDiL Oy C12360_STRADA-2x2-DNW_(MJT4040) Eff.94.0% / LDC (Polar)

Luminaire: LEDiL Oy C12360_STRADA-2x2-DNW_(MJT4040) Eff.94.0%

Lamps: 1 x SEOUL ACHRICH MJT4040 (SAW09H0A) 251.5lm@40mA P=2.37W I=40mA

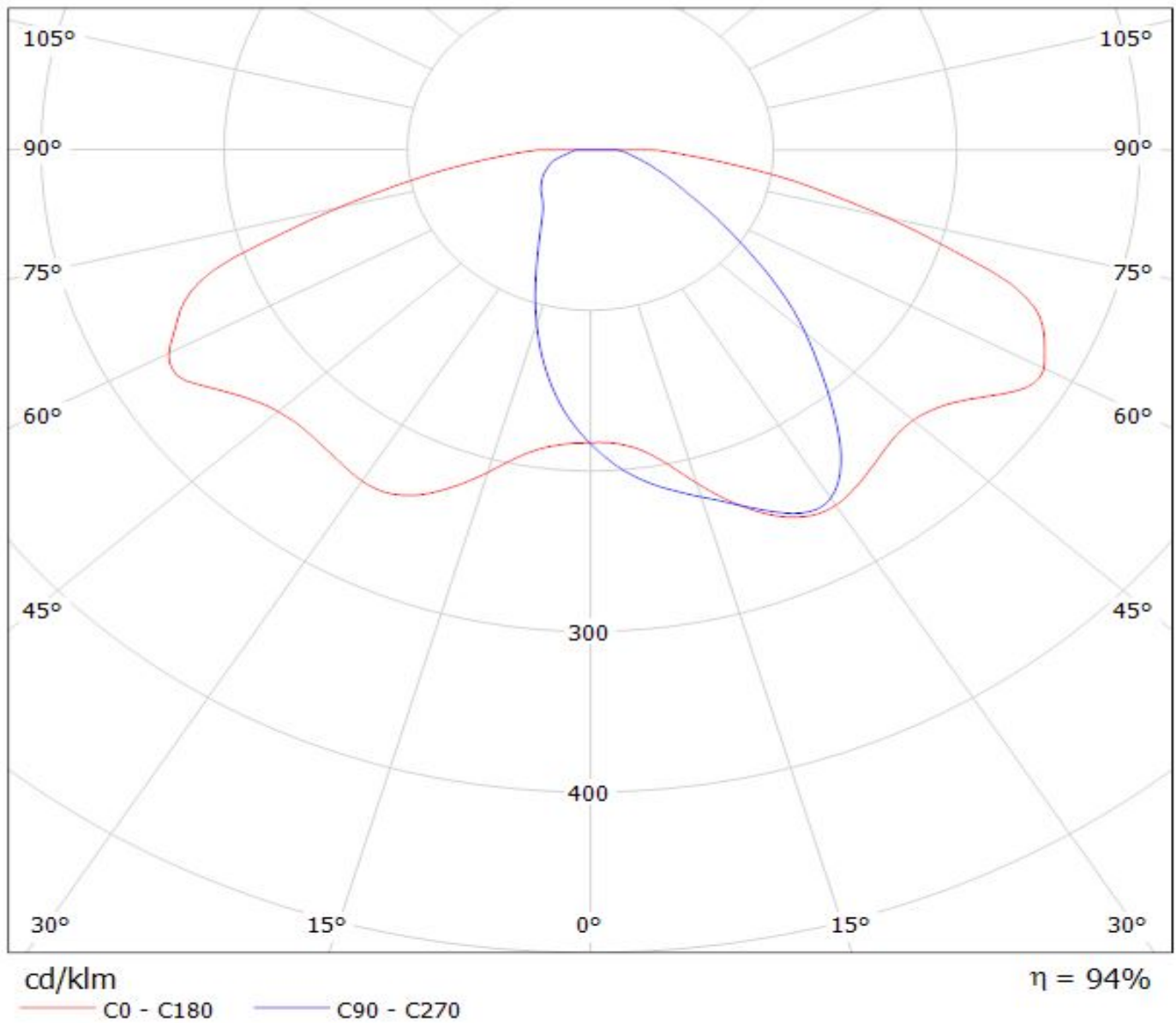

Luminaire: LEDil Oy C12360_STRADA-2X2-DNW_(Z5M1) Efficiency=94%
Lamps: 1 x Seoul Z5M1 (SZ5-M1-WN-C8) 379lm @ 250mA CCT=4600K P=2.9W I=250mA

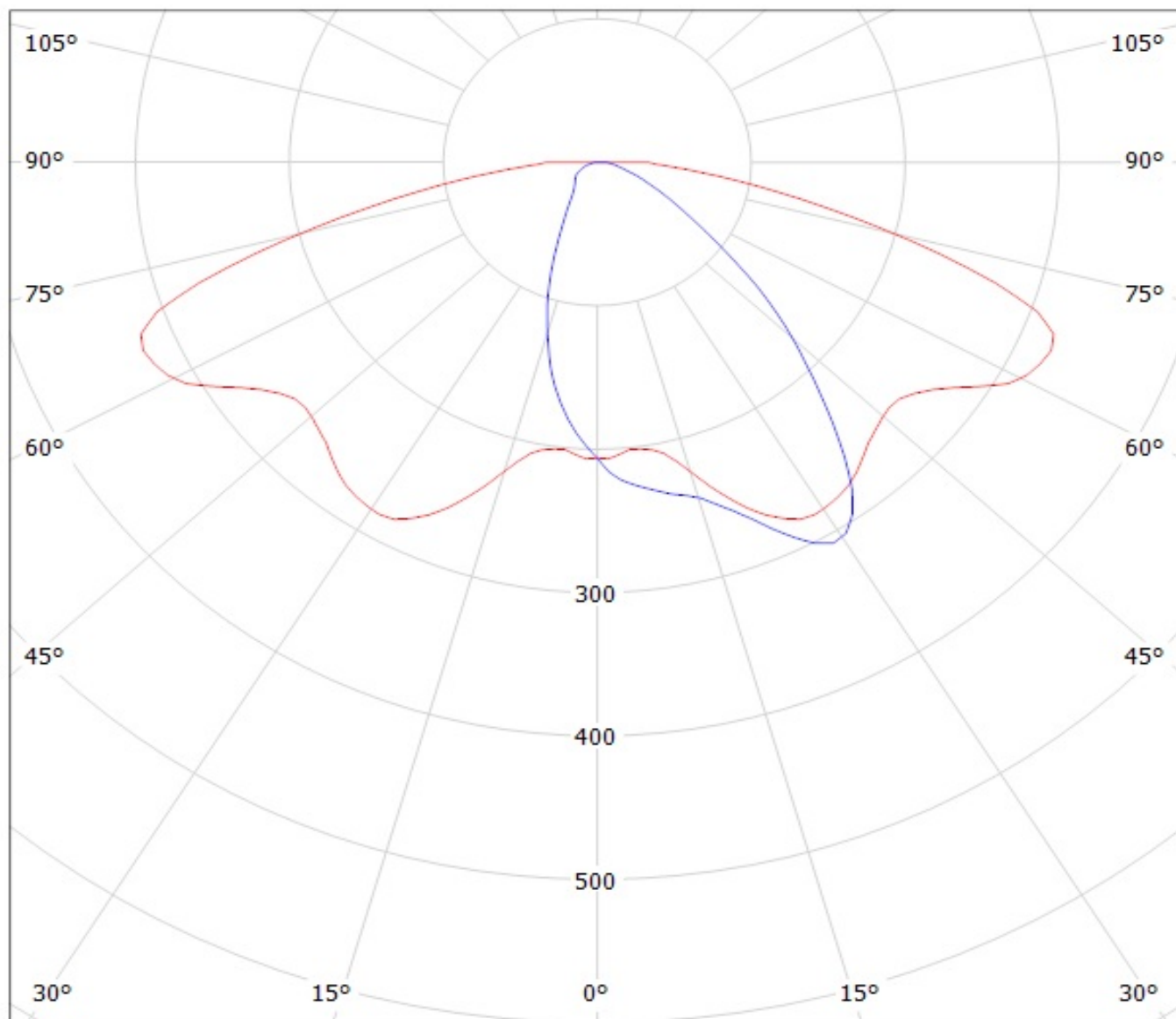

cd/klm

— C0 - C180 — C90 - C270

Ledil C12360_STRADA-2X2-DNW_(TL1L3) / LDC (Polar)

Luminaire: Ledil C12360_STRADA-2X2-DNW_(TL1L3)

Lamps: 1 x Toshiba_TL1L3_2x2_(TL1L3-NW1.L)_387.773lm@250mA_CCT=5000K_P=2.829W_I=0.25A

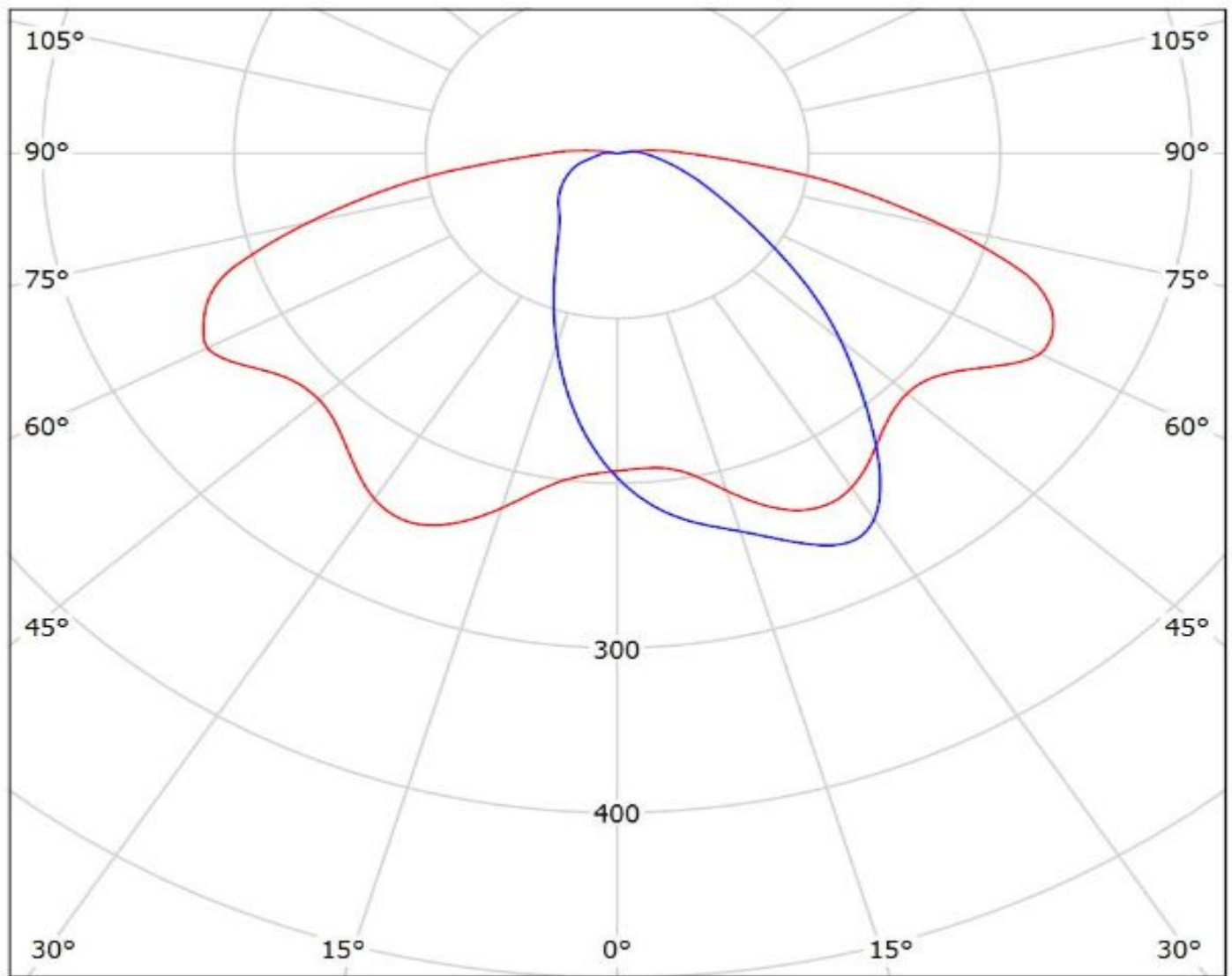

cd/klm

— C0 - C180 — C90 - C270

$\eta = 94\%$

Ledil C12360_STRADA-2X2-DNW_(TL1L4) / LDC (Polar)

Luminaire: Ledil C12360_STRADA-2X2-DNW_(TL1L4)

Lamps: 1 x Toshiba_TL1L4_2x2_(TL1L4-DW0)_472.639lm@250mA_CCT=6500K_P=2.9W_I=0.25A

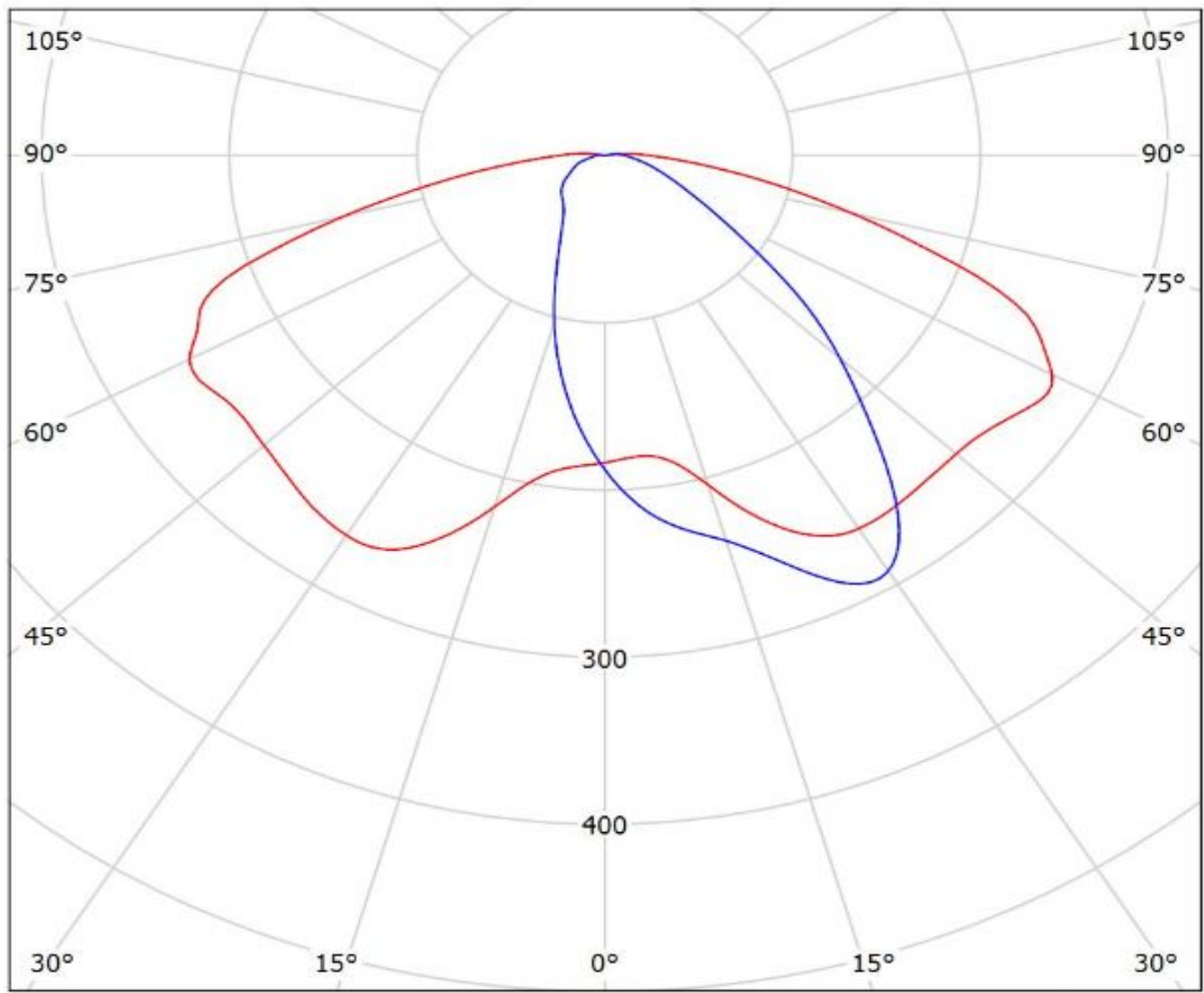

cd/klm

— C0 - C180

— C90 - C270

$\eta = 94\%$

Luminaire: LEDiL Oy C12360_STRADA-2X2-DNW_(Tridonic_Module_RLE_G1)
Lamps: 1 x Tridonic_Module_RLE_G1_4576.03lm@700mA_P=32.0681W_I=0.700A

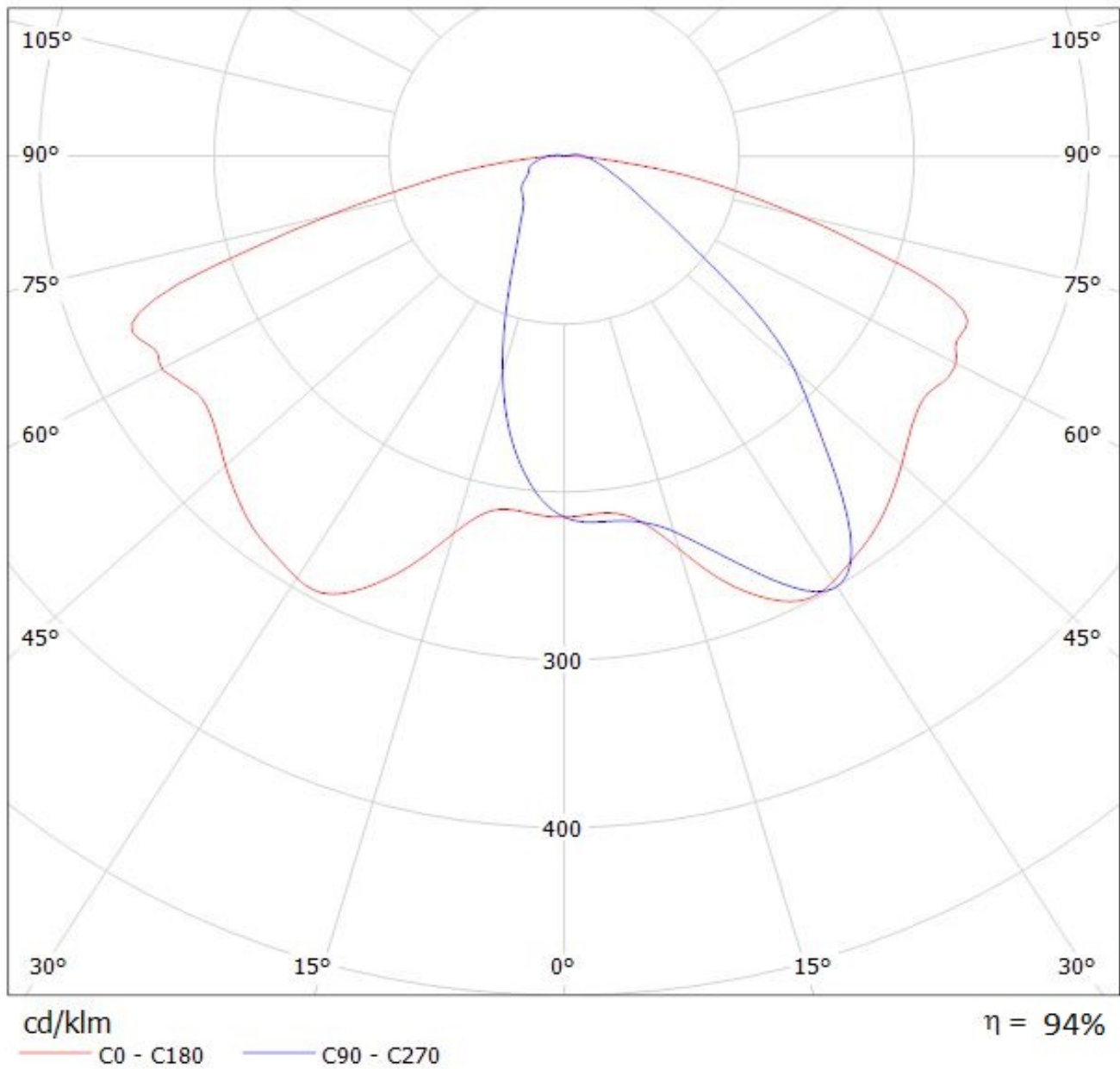

Luminaire: LEDiL Oy C12360_STRADA-2X2-DNW_(Tridonic_Module_RLE_G1)
Lamps: 1 x Tridonic_Module_RLE_G1_4576.03lm@700mA_P=32.0681W_I=0.700A

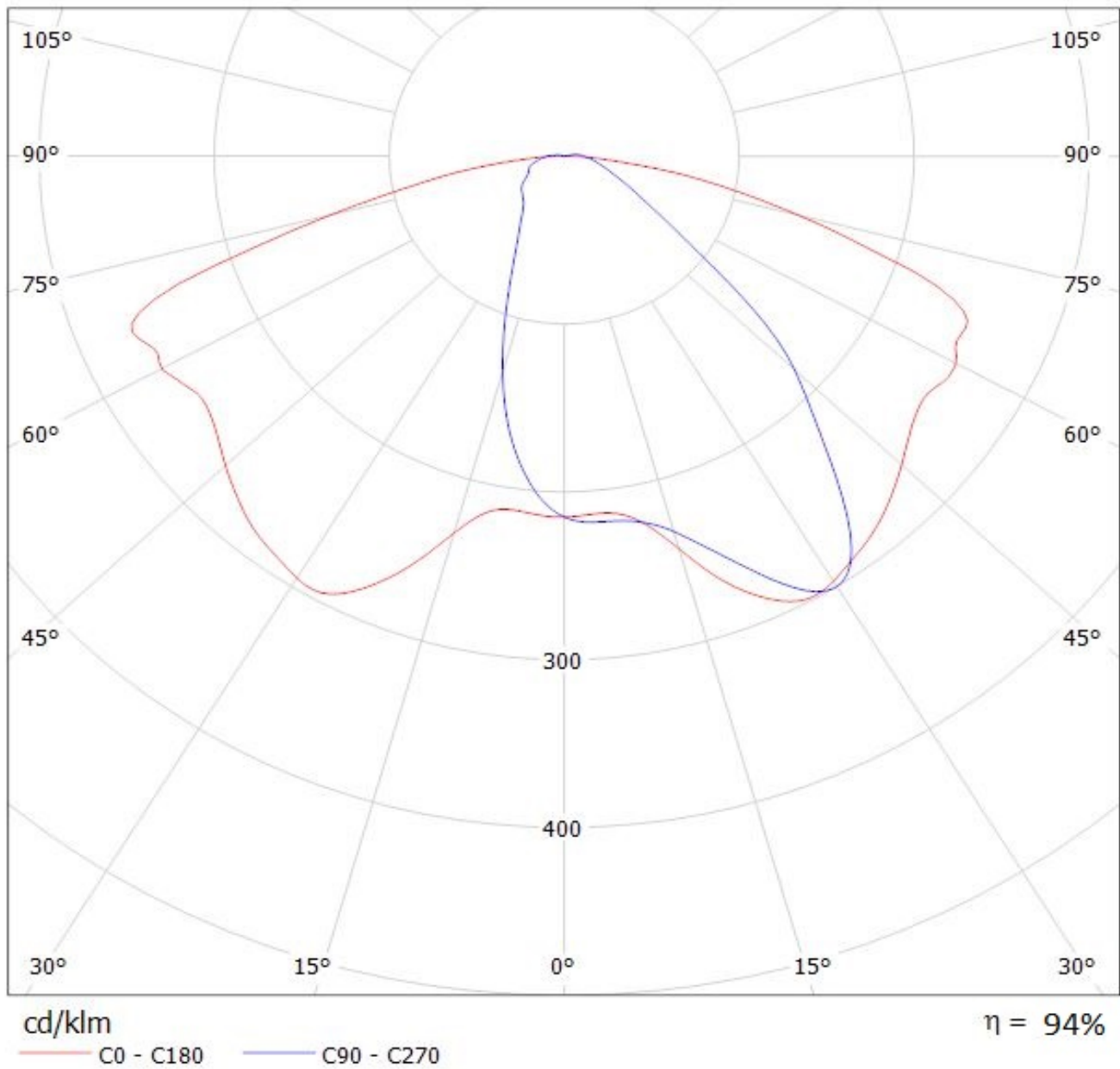

Luminaire: LEDiL Oy C12360_STRADA-2X2-DNW_(Tridonic_Module_RLE_G1)
Lamps: 1 x Tridonic_Module_RLE_G1_2288lm@700mA_P=16W_I=0.700A

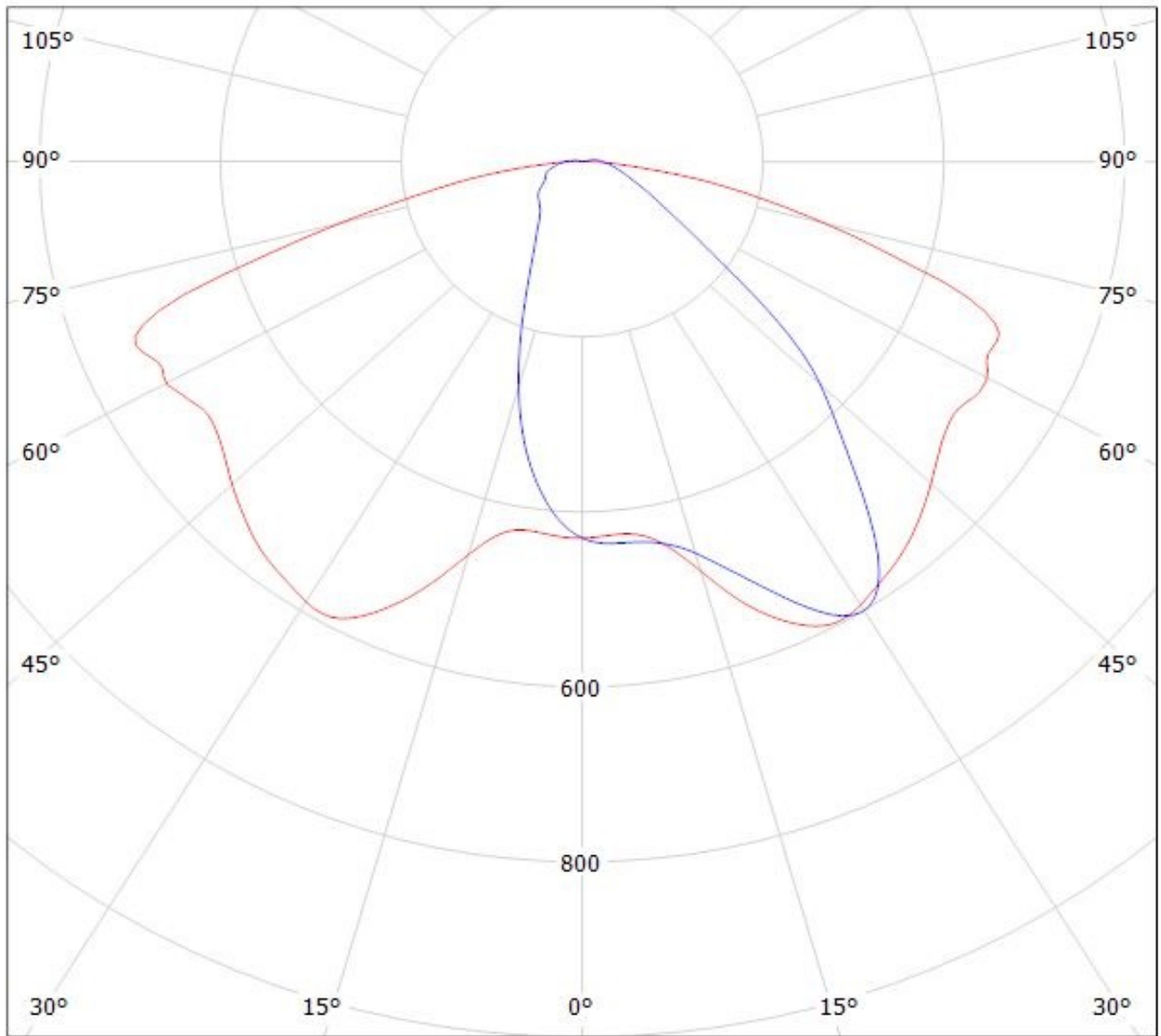

cd/klm

— C0 - C180 — C90 - C270

$\eta = 94\%$

Luminaire: LEDiL Oy C12360_STRADA-2X2-DNW_(Tridonic_Module_RLE_G1)
Lamps: 1 x Tridonic_Module_RLE_G1_2288lm@700mA_P=16W_I=0.700A

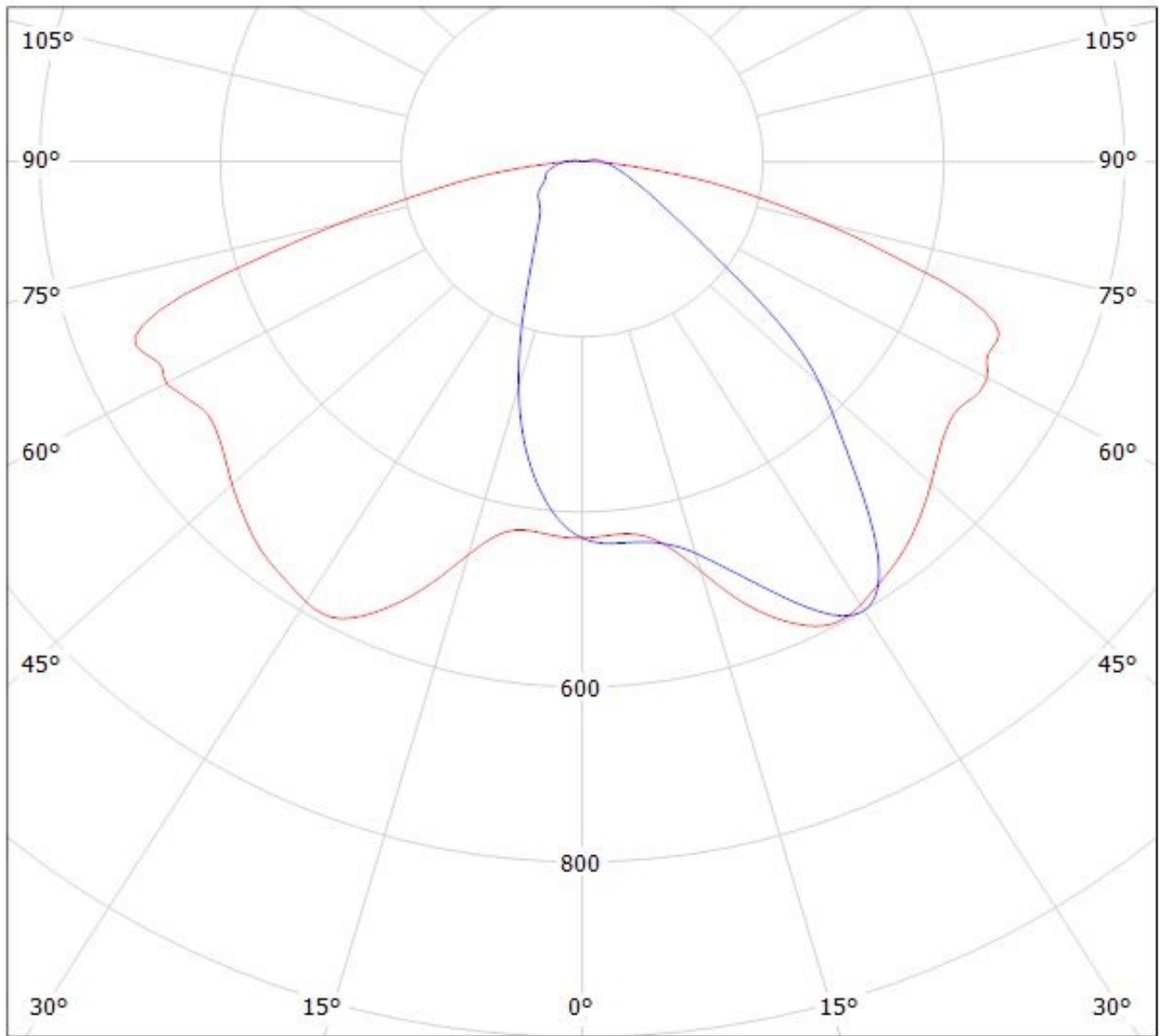

cd/klm

— C0 - C180 — C90 - C270

$\eta = 94\%$

NOTE: The typical divergence will be changed by different color, chip size and chip position tolerance. The typical total divergence is the full angle measured where the luminous intensity is half of the peak value.