

ENERGIZER 123
(EL123AP)

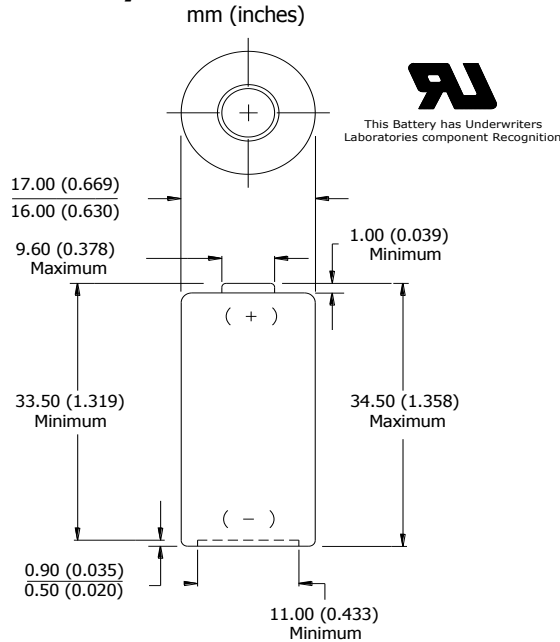

Industry Standard Dimensions



This battery contains a Positive Temperature Coefficient (PTC) safety device to limit current during short circuit conditions.

Specifications

- Classification:** "Lithium"
- Chemical System:** Lithium / Manganese Dioxide (Li/MnO₂)
- Designation:** ANSI-5018LC, IEC-CR17345
- Nominal Voltage:** 3.0 Volts
- Storage Temp:** -40°C to 60°C (-40°F to 140°F)
- Operating Temp:** -40°C to 60°C (-40°F to 140°F)
- Typical Capacity:** 1500 mAh (to 2.0 volts)
(Rated at 100 ohms at 21°C)
- Typical Weight:** 16.5 grams (0.58 oz.)
- Typical Volume:** 7.0 cubic centimeters (0.4 cubic inch)
- Max Discharge:** 1500 mA continuous (3500 mA pulse)
- Max Rev Current:** 2 uA
- Typical Li Content:** 0.55 grams (0.019 oz.)
- UL Listed:** MH12454

Typical Discharge Characteristics

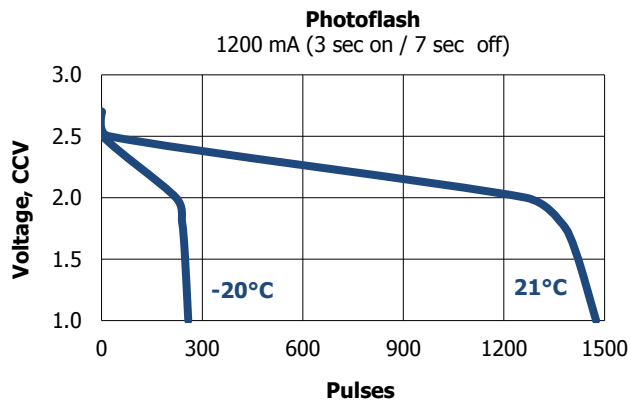
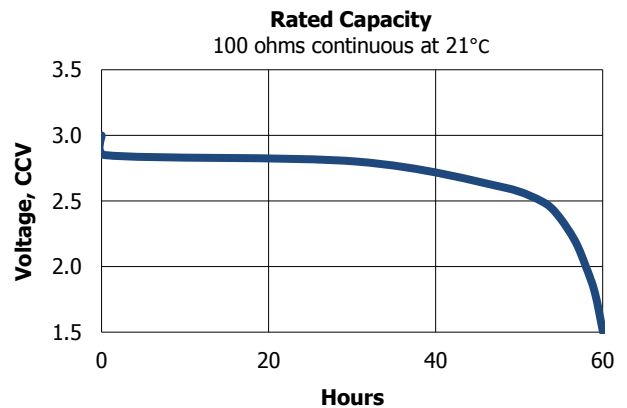

Simulated Application Tests

Typical Use Performance

Type (time)	Drain (mA)	Load (ohms)	Cutoff Voltage		
			2.0V (21°C) (hours)	1.8V (21°C) (pulses)	1.55V (21°C) (pulses)
Capacity (continuous)	---	100	58	---	---
Photoflash (3 / 27 sec)	900	---	---	---	2000
Photoflash (3 / 7 sec)	1200	---	---	1370	---
Photoflash (3 / 7 sec)	1800	---	---	860	---

Important Notice

This datasheet contains typical information specific to products manufactured at the time of its publication.
©Energizer Holdings, Inc. - Contents herein do not constitute a warranty.