

### STEVAL-ILL022V1 solar-LED streetlight controller with 25 W LED lamp driver and 80 W battery charger based on the STM32F101Rx

#### Introduction

The solar-LED streetlight controller consists of one 80 W battery charger and one 25 W LED driver. During the daytime, when there is sufficient sunlight, the charger converts the electricity from the solar panel and charges the battery. At nighttime, the battery powers on the LED lamp as streetlight.

If it is rainy or cloudy for several continuous days, the battery will gradually run out of power. The controller then resorts to the AC mains supply to power on the LED until the battery has had time to fully charge again.

#### Main features of the solar-LED streetlight controller

- Maximization of electricity conversion efficiency from solar panel by way of maximum power point tracker (MPPT)
- Automatic day/night/weather detection
- Automatic battery/mains switch over
- Constant current control for LED lamp
- Battery charge control
- Optional LED lighting duration mode
- Easy system monitoring via debug LED indicators
- Full protection function for OTP, OCP and UVP

**Figure 1. Snapshot of the solar-LED streetlight controller**

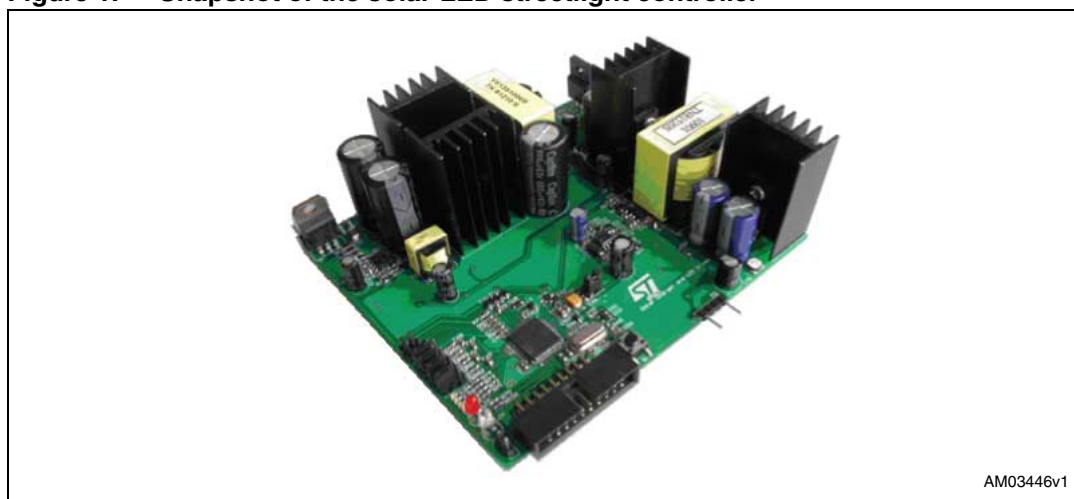

# Contents

<b>1</b>	<b>Safety instructions</b> .....	<b>4</b>
1.1	Intended use .....	4
1.2	Installation .....	4
1.3	Electrical connection .....	4
1.4	Board operation .....	4
<b>2</b>	<b>General description</b> .....	<b>5</b>
<b>3</b>	<b>Hardware description</b> .....	<b>6</b>
3.1	Board description .....	6
3.2	Controller characteristics .....	7
<b>4</b>	<b>Operating instructions</b> .....	<b>8</b>
4.1	Hardware installation .....	8
4.2	Recommended peripheral parameters .....	8
4.2.1	Solar panel .....	8
4.2.2	Battery .....	8
4.2.3	LED .....	8
4.2.4	Mains switch .....	9
4.3	Troubleshooting .....	9
<b>5</b>	<b>DIP selection and LED indicator</b> .....	<b>10</b>
5.1	DIP selection switch .....	10
5.2	LED indicator .....	10
<b>6</b>	<b>Schematic and bill of materials</b> .....	<b>12</b>
<b>7</b>	<b>Revision history</b> .....	<b>17</b>

## List of tables

Table 1.	Description of functions . . . . .	6
Table 2.	Recommended electrical parameters for solar panel . . . . .	8
Table 3.	Recommended electrical parameters for battery . . . . .	8
Table 4.	Recommended electrical parameters for LED . . . . .	8
Table 5.	Symptoms and corrective action. . . . .	9
Table 6.	DIP switch for LED lamp light-on time selection . . . . .	10
Table 7.	LED indicator and error message . . . . .	10
Table 8.	BOM . . . . .	13
Table 9.	Pin strip header. . . . .	16
Table 10.	Document revision history . . . . .	17

---

# 1 Safety instructions

---

**Warning:** The demonstration board must be used in a suitable laboratory by qualified personnel only, familiar with the installation, use and maintenance of electrical systems.

---

## 1.1 Intended use

The demonstration board is a component designed for demonstration purposes *only*, and **shall not** be used for domestic or industrial installations. The technical data and information concerning the power supply and working conditions must be taken from the documentation provided with the delivery, and must be strictly observed.

## 1.2 Installation

The installation instructions of the demonstration board must be taken from the present document and strictly observed. The components must be protected against excessive strain. In particular, no components are to be bent, or isolating distances altered, during the transportation, handling or use. The demonstration board contains electro-statically sensitive components that are prone to damage through improper use. Electrical components must not be mechanically damaged or destroyed (to avoid potential risks and health injury).

## 1.3 Electrical connection

Applicable national accident prevention rules must be followed when working on the mains power supply. The electrical installation must be completed in accordance with the appropriate requirements (e.g. cross-sectional areas of conductors, fusing and PE connections).

## 1.4 Board operation

A system architecture that supplies power to the demonstration board must be equipped with additional control and protective devices in accordance with the applicable safety requirements (e.g. compliance with technical equipment and accident prevention rules).

## 2 General description

The solar-LED streetlight controller is the key element of the system, also comprising the solar panel, battery and LED streetlight (lamp). *Figure 2* shows the structure of the system.

**Figure 2. System block diagram**

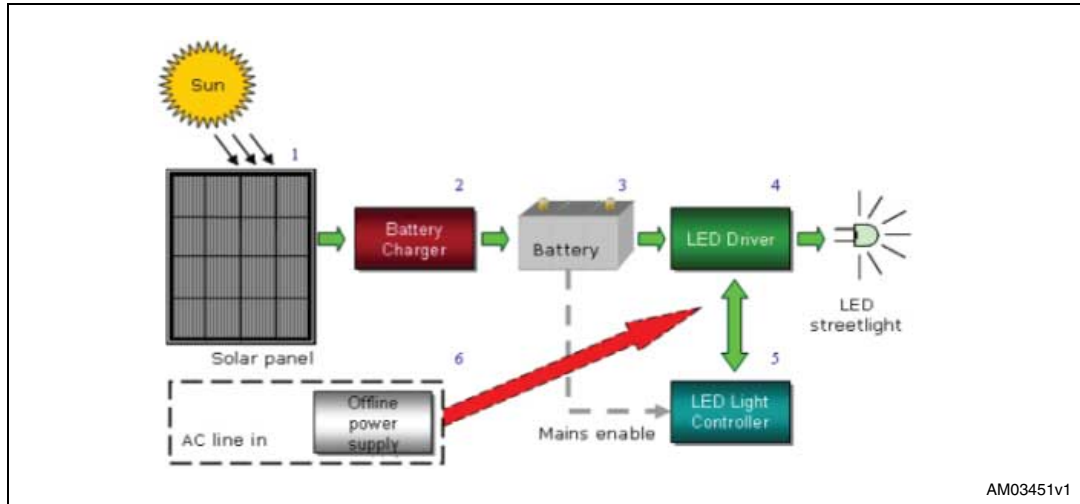

Each block's function is described below.

- The sunlight delivers pockets of photons (solar energy) to the solar panel (also called photovoltaic or PV module). The photons (energy) are absorbed by the PV module and electrons are released.
- The electrons flow along the metal contact of the PV module and create electricity. The battery charger then converts the electrical energy and charges the battery.
- The battery stores the electricity supplied by the battery charger. The controller monitors the status of the battery.
- The LED lamp (LED streetlight) is activated by the LED driver. The LED light controller monitors the system and controls the light-on and light-off in daytime and nighttime.
- When the battery goes low, the controller sends an enable signal to the mains switch and the AC offline power supply is enabled. The AC offline power supply (not covered in this document) acts as a backup source to power the LED streetlight.





The solar-LED streetlight controller plays the key role in the system for electricity (solar energy) storage control and LED lamp light-on/-off control.

### 3 Hardware description

#### 3.1 Board description

Table 1 describes the various functions of the controller’s demonstration board. Figure 3 provides the top view of the board.

**Table 1. Description of functions**

Category	Index	Designator	Description	
System connectors	1	P1	Solar panel connector	
	2	P4	Battery temperature sensor connector (connected to NTC)	
	3	P5	LED lamp temperature sensor connector (connected to NTC)	
	7	P6	Mains enable output	
	10	P3	LED lamp connector	
	11	P2	Battery connector	
HMI	4	SW1~SW4	DIP switch <sup>(1)</sup> : mode selection	
	5	LED1~LED4	Debug indicators <sup>(2)</sup>	
	6	LED5, LED6	LED 5 (red)	ON: battery charged
				OFF: battery not charged
			LED 6 (white)	ON: battery full
				OFF: battery not full
	9	PB1	Reset	
ICP interface	8	CN1	JTAG	

1. Refer to Table 6 for dip selection mapping.  
 2. Refer to Table 7 for debug message mapping.

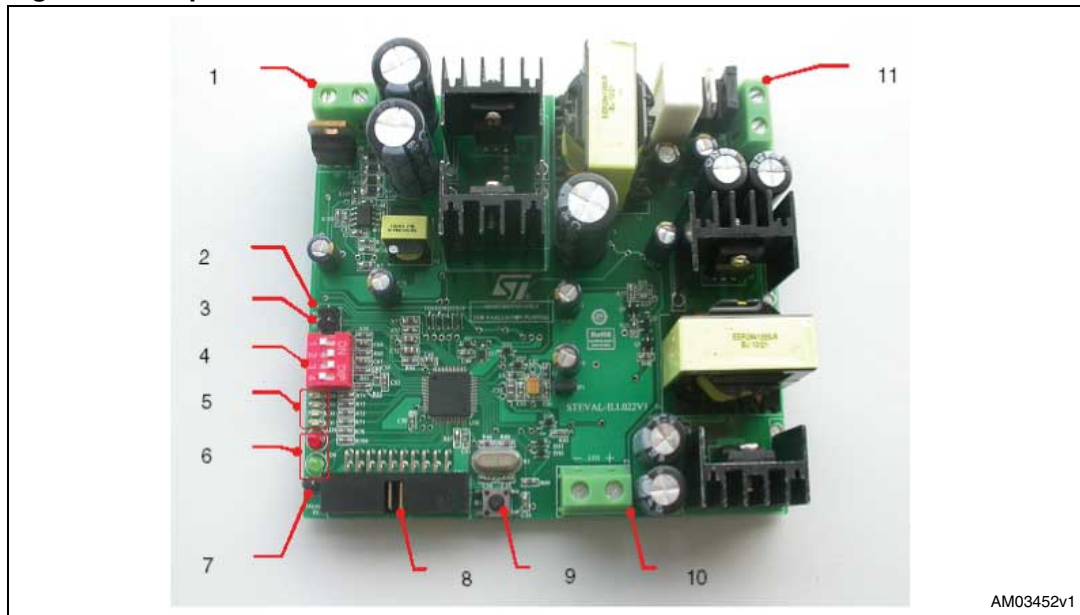
**Figure 3. Top view of demonstration board**

## 3.2 Controller characteristics

The controller has the following characteristics.

- Battery operation voltage:
  - 13.8 V max./11 V min. for 12 V system
- Charger:
  - input voltage range  $\leq 50$  VDC
  - output power  $\leq 80$  W
- LED lamp driver:
  - output current 2.45 A
  - output power  $\leq 25$  W
- Dimensions:
  - 113 mm x 98 mm x 50 mm

## 4 Operating instructions

### 4.1 Hardware installation

The following steps are to install the hardware.

1. Connect an NTC resistor (battery temperature sensor) to P4 (refer to [Section 3.1](#)).
2. Connect an NTC resistor (LED lamp temperature sensor) to P5 (refer to [Section 3.1](#)).
3. Connect the mains switch controller enable input to P6 (refer to [Section 3.1](#)).
4. Set SW1~SW4 according to DIP selection mapping table ([Table 6](#)).
5. Connect P3 (refer to [Section 3.1](#)) to LED lamp.
6. Connect P2 (refer to [Section 3.1](#)) to battery.
7. Connect P1 (refer to [Section 3.1](#)) to solar panel.

### 4.2 Recommended peripheral parameters

#### 4.2.1 Solar panel

**Table 2. Recommended electrical parameters for solar panel**

Parameters	Symbol	Typ	Unit	Condition
Maximum power	$P_{max}$	80	W	Irradiance: 1000 W/m <sup>2</sup> Module temperature: 25°C
Maximum power voltage	$V_{pm}$	17.8	V	
Maximum power current	$I_{pm}$	4.52	A	
Open circuit voltage	$V_{oc}$	21.82	V	
Short circuit current	$I_{sc}$	5.01	A	
Module efficiency	$\eta_m$	13.42	%	

#### 4.2.2 Battery

**Table 3. Recommended electrical parameters for battery**

Parameters	Typ	Unit
Nominal capacity	50	Ah
Nominal voltage	12	V

#### 4.2.3 LED

**Table 4. Recommended electrical parameters for LED**

Parameters	Typ	Unit
Nominal power	25	W
Nominal current	2.45	A



#### 4.2.4 Mains switch

When the battery is low, a high logic level output is generated by the MCU, which then enables the mains power.

### 4.3 Troubleshooting

Table 5. Symptoms and corrective action

Symptom	Corrective action
None of the LED(s) is powered on. The LED(s) include LED lamp, debug LED and battery status LED	<ul style="list-style-type: none"> <li>– Set-up the system as per the hardware installation procedure described in <a href="#">Section 4.1</a>.</li> <li>– Check the mains enable signal on P6. A high logic level indicates that the battery voltage is too low to power the LED light. This status will persist until the battery is fully charged.</li> <li>– Reset the system by pressing the reset button (PB1).</li> <li>– Check the battery type and polarity. Only 12 V battery can be applied to this system. If the battery has previously been connected reversely, replace the fuse (F1) with a new one.</li> <li>– Check that the LED lamp is available.</li> </ul>
Battery status LED fails to light during daytime	<ul style="list-style-type: none"> <li>– Set-up the system as per the hardware installation procedure described in <a href="#">Section 4.1</a>.</li> <li>– Reset the system by pressing the reset button (PB1).</li> <li>– Check that it is not too dark to enable the solar panel's output.</li> <li>– Check that the solar panel is available.</li> </ul>
Dim LED lamp	<ul style="list-style-type: none"> <li>– Try to cool down the LED lamp.</li> <li>– Check that the LED lamp's lifecycle is still valid.</li> </ul>

## 5 DIP selection and LED indicator

### 5.1 DIP selection switch

The DIP switches DIP1, DIP2, DIP3 and DIP4 are used to define the LED lamp's *on* time after the "switch on" signal has been received from the MCU. [Table 6](#) describes the jumper positions of each switch. The positions 'L' and 'H' are shown in [Table 1](#).

**Table 6. DIP switch for LED lamp light-on time selection**

Status	DIP 1	DIP 2	DIP 3	DIP 4	Mode description
1	L	L	L	L	Switch on LED for 5 minutes, then turn-off
2	H	L	L	L	Switch on LED for 2 hours during nighttime
3	L	H	L	L	Switch on LED for 4 hours during nighttime
4	H	H	L	L	Switch on LED for 6 hours during nighttime
5	L	L	H	L	Switch on LED for 8 hours during nighttime
6	H	L	H	L	Switch on LED for 10 hours during nighttime
7	L	H	H	L	Switch on LED for 12 hours during nighttime
8	H	H	H	L	Always switch on LED
9	-	-	-	H	Always switch on LED at nighttime

### 5.2 LED indicator

The demonstration board has four LED indicators, LED1, LED2, LED3 and LED4, which are used to indicate any error messages during operation. [Table 7](#) describes each type of error message. The messages are there to assist technicians in their troubleshooting and maintenance tasks.

**Table 7. LED indicator and error message**













































LED 1	LED 2	LED 3	LED 4	Error message
				No error
				Battery charger overheat
				Battery overheat
				LED driver overheat
				LED overheat
				Incorrect solar panel polarity

Table 7. LED indicator and error message (continued)

LED 1	LED 2	LED 3	LED 4	Error message
				Battery over-voltage or under-voltage
				Battery overcurrent
				LED over-voltage
				Abnormal LED driving current
				Short-circuit in LED driver

# 6 Schematic and bill of materials

Figure 4. Board schematic

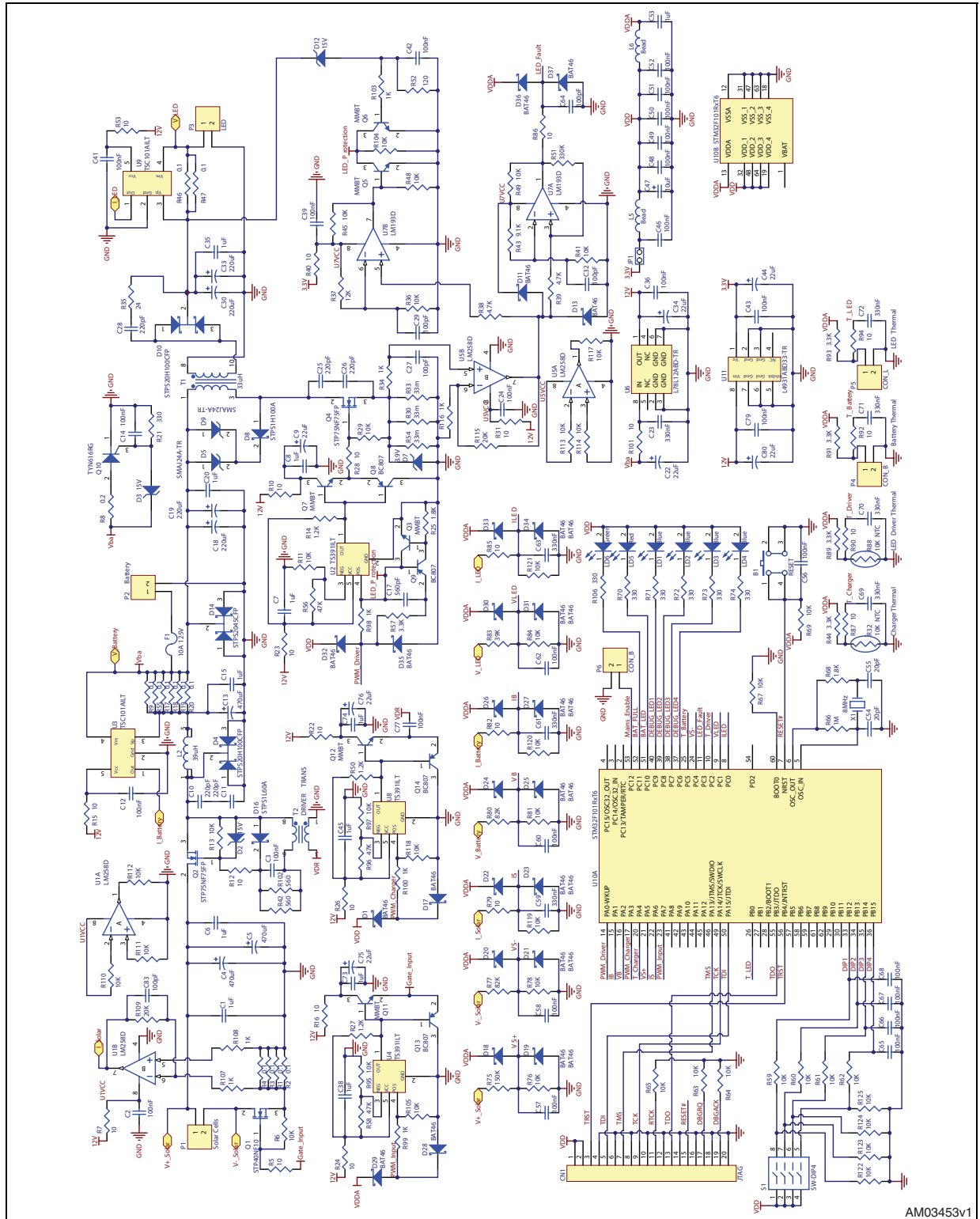

Table 8. BOM

Reference	Value / generic part number	Package /class
B1	One way 6x6 mm	(SMD), 4.3 mm(H), tactile switch
C1, C6	1 $\mu$ F	(1210), 100 V, ceramic capacitor
C2, C3, C12, C14, C24, C36, C39, C41, C42, C43, C46, C48, C49, C50, C51, C52, C56, C57, C58, C60, C62, C65, C66, C67, C68, C77, C79	100 nF	(0603), 50 V, ceramic capacitor
C4, C5, C13	470 $\mu$ F	63 V, Al-cap electrolytic capacitor
C7, C8, C35, C38, C45, C53, C73, C74	1 $\mu$ F	(0805), 25 V, ceramic capacitor
C9, C22, C34, C44, C75, C76, C80	22 $\mu$ F	50 V, Al-cap electrolytic capacitor
C10, C11, C25, C26	220 pF	(0805), 50 V, ceramic capacitor
C15, C20	1 $\mu$ F	(1206), 50 V, ceramic capacitor
C17	560 pF	(0603), 50 V, ceramic capacitor
C18, C19, C30, C33	220 $\mu$ F	50 V, Al-cap electrolytic capacitor
C23, C59, C61, C63, C69, C70, C71, C72	330 nF	(0805), 50 V, ceramic capacitor
C27, C29, C32, C64, C83	100 pF	(0603), 50 V, ceramic capacitor
C28	220 pF	(0603), 250 V, ceramic capacitor
C47	10 $\mu$ F	(3528-21), 16 V, tantalum
C54, C55	20 pF	(0603), 50 V, ceramic capacitor
CN1	20-way Box header	(Right angle mounting), JTAG connector
D1, D11, D13, D17, D18, D19, D20, D21, D22, D23, D24, D25, D26, D27, D28, D29, D30, D31, D32, D33, D34, D35, D36, D37	BAT46JFILM	(SOD323), small signal Schottky diode
D2, D3, D12	15 V	(SOD 80C), Zener diode
D4, D10	STPS20H100CFP	(TO-220FPAB), power Schottky rectifier
D5, D9	SMAJ24A-TR	(SMA or DO-214AC), 24 V 400 W Transil™ (TVS)
D7	3.9 V	(SOD 80C), Zener diode
D8	STPS1H100A	(SMA or DO-214AC), power Schottky rectifier
D14	STPS2045CFP	(TO-220FPAB), power Schottky rectifier
D16	STPS1L60A	(SMA or DO-214AC), power Schottky rectifier
F1	10 A	(2.54 x 7.2 mm, axial lead), 251 series fuse
JP1 (see <a href="#">Table 9</a> )	0.64x0.64 mm, 2 way	2.54 mm pitch, pin strip header

Table 8. BOM (continued)

Reference	Value / generic part number	Package /class
L2 (see <a href="#">Table 9</a> )	39 $\mu$ H	Inductor
L5, L6	600 $\Omega$ @ 100 MHz	(0603), Chip ferrite bead, 25%, 200mA max.
LD1, LD2, LD3, LD4	80 mcd, yellow	(0603), LED
LD5	45 mcd, red	(3.0, diffused, radio lead), LED
LD6	10 mcd, green	(3.0, undiffused, radio lead), LED
P1, P2, P3	Terminal block	2 Terminal, pitch 7.5mm
P4, P5, P6	Header, 2 pin	HDR1x2, pitch 2.54mm
Q1	STP40NF10	(TO-220), N-channel MOSFET
Q2, Q4	STP75NF75FP	(TO-220FP), N-channel MOSFET
Q3, Q5, Q6, Q7, Q11, Q12	MMBTA42	(SOT-23), NPN bipolar transistor
Q8, Q9, Q13, Q14	BC807	(SOT-23), PNP bipolar transistor
Q10	TYN616RG	(TO-220AB), Triac
R1, R2, R3, R4, R9, R17, R18, R19, R20, R46, R47, R55	0.1 $\Omega$	(1206), 1%, resistor
R5, R7, R10, R12, R15, R16, R22, R23, R24, R26, R28, R31, R40, R53, R101	10 $\Omega$	(0805), 1%, resistor
R6, R13, R29	10 k $\Omega$	(0805), 5%, resistor
R8	0.2 $\Omega$	(Axial lead), cement, 2W, resistor
R11, R45, R48, R49, R59, R60, R61, R62, R63, R64, R65, R67, R69, R95, R97, R104, R105, R110, R111, R112, R113, R114, R117, R118, R119, R120, R121, R122, R123, R124, R125	10 k $\Omega$	(0603), 5%, resistor
R14, R27, R50	1.2 k $\Omega$	(0805), 5%, resistor
R21, R70, R71, R72, R73, R74, R106	330 $\Omega$	(0603), 5%, resistor
R25	1.8 k $\Omega$	(0603), 5%, resistor
R30, R33, R54	33 m $\Omega$	(1210), 1%, resistor
R32, R88	NTC, 10 k $\Omega$	(0805), NTC resistor
R34, R107, R108, R116	1 k $\Omega$	(0603), 1%, resistor
R35	24 $\Omega$	(1206), 5%, resistor
R36, R41	10 k $\Omega$	(0603), 1%, resistor
R37	12 k $\Omega$	(0603), 1%, resistor
R38, R39	4.7 k $\Omega$	(0603), 5%, resistor
R102	560 $\Omega$	(1206), 5%, resistor

Table 8. BOM (continued)

Reference	Value / generic part number	Package /class
R43	9.1 k $\Omega$	(0603), 1%, resistor
R44, R89, R91, R93	3.3 k $\Omega$	(0603), 1%, resistor
R51	330 k $\Omega$	(0603), 5%, resistor
R52	120 $\Omega$	(0603), 5%, resistor
R56, R58, R96	47 k $\Omega$	(0603), 5%, resistor
R57	3.3 k $\Omega$	(0603), 5%, resistor
R66	1 M $\Omega$	(0603), 1%, resistor
R68	1.8 k $\Omega$	(0603), 1%, resistor
R75	150 k $\Omega$	(0805), 1%, resistor
R76, R78, R81, R84	10 k $\Omega$	(0805), 1%, resistor
R77, R80	82 k $\Omega$	(0805), 1%, resistor
R79, R82, R85, R86, R87, R90, R92, R94	10 $\Omega$	(0603), 5%, resistor
R83	39 k $\Omega$	(0805), 1%, resistor
R98, R99, R100, R103	1 k $\Omega$	(0603), 5%, resistor
R109, R115	20 k $\Omega$	(0603), 1%, resistor
S1	DIP switch	4 Position DIP Switch
T1 (see <a href="#">Table 9</a> )	33 $\mu$ H	EER25.5, transformer
T2 (see <a href="#">Table 9</a> )	1 mH	Driver transformer
U1, U5	LM258D	(SO8 narrow), dual operational amplifiers
U2, U4, U8	TS391ILT	(SO), single voltage comparator
U3, U9	TSC101AILT	(SO), current sense IC
U6	L78L12ABD-TR	(SO8 narrow), positive voltage regulator
U7	LM193D	(SO8), dual voltage comparator
U10	STM32F101RXT6	(LQFP64), 32-bit microprocessor
U11	L4931ABD33-TR	(SO8 narrow), linear regulator
X1	8 MHz	(3 x 8), crystal oscillator
Reference	Value / generic part number	Package /class

Note: *STM32F101R4, STM32F101R6, STM32F101R8, STM32F101RB, STM32F101RC, STM32F101RD and STM32F101RE are all equivalent for the purpose.*

Table 9. Pin strip header

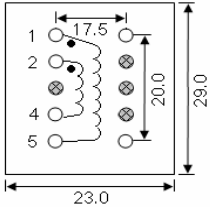
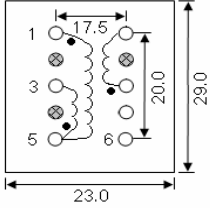
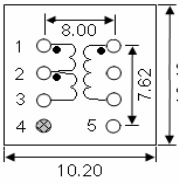
Figure	Description
Accessory for JP1	M20 series jumper socket
 <p>Remarks: Marking ⊗ shows no pin</p>	<p>L2</p> <ul style="list-style-type: none"> <li>- 1: 39 <math>\mu</math>H +/- 4% (W1//W2 and twisted)</li> <li>- 2: Winding 1: pin 1 to pin 5 (18 turns CCW)</li> <li>- 3: Winding 2: pin 2 to pin 4 (18 turns CCW)</li> <li>- 4: Wire gage: AWG31*20</li> <li>- 5: Core: EER28-Z-PC40</li> <li>- 6: Bobbin: BEER28-1110CPFR</li> </ul>
 <p>Remarks: Marking ⊗ shows no pin</p>	<p>T1</p> <ul style="list-style-type: none"> <li>- 1: 33 <math>\mu</math>H +/- 4% (W1+W3 at 50 kHz, 1 Vrms)</li> <li>- 2: Leakage &lt; 0.1 <math>\mu</math>H (W2 short-circuit)</li> <li>- 2: Winding 1: pin 1 to pin 5 (5 turns CCW)</li> <li>- 3: Winding 2: pin 8 to pin 10 (10 turns CCW)</li> <li>- 4: Winding 3: pin 5 to pin 3 (5 turns CCW)</li> <li>- 4: Wire gage: AWG31*20</li> <li>- 5: Core: EER28-Z-PC40</li> <li>- 6: Bobbin: BEER28-1110CPFR</li> </ul>
 <p>Remarks: Marking ⊗ shows no pin</p>	<p>T2</p> <ul style="list-style-type: none"> <li>- 1: 1 mH (W1+W3 at 50 kHz, 1 Vrms)</li> <li>- 2: Leakage &lt; 10 <math>\mu</math>H (W2 short-circuit)</li> <li>- 3: No air-gap is required</li> <li>- 2: Winding 1: pin 1 to pin 2 (17 turns CCW)</li> <li>- 3: Winding 2: pin 8 to pin 6 (34 turns CCW)</li> <li>- 4: Winding 3: pin 2 to pin 3 (17 turns CCW)</li> <li>- 4: Wire gage: AWG31</li> <li>- 5: Core: EE10/11-Z-PC40</li> <li>- 6: Bobbin: BE10-118CPSFR</li> </ul>



## 7 Revision history

Table 10. Document revision history

Date	Revision	Changes
08-Jan-2010	1	Initial release
28-Sep-2010	2	<ul style="list-style-type: none"><li>– Changed: connectors</li><li>1: P1: solar panel connector</li><li>2: P2: battery connector</li><li>3: P3: LED lamp connector</li><li>4: SW1~SW4: mode selection DIP switch</li><li>– Battery use only 12VDC type</li><li>– <a href="#">Figure 1</a> changed due to the connectors outline changed</li><li>– Re-new the connectors' location in <a href="#">Figure 3</a> which is based on the description in <a href="#">Table 1</a></li><li>– <a href="#">Figure 4</a>, the schematic is updated</li><li>– <a href="#">Table 8</a>, the BOM is updated</li></ul>

**Please Read Carefully:**

Information in this document is provided solely in connection with ST products. STMicroelectronics NV and its subsidiaries ("ST") reserve the right to make changes, corrections, modifications or improvements, to this document, and the products and services described herein at any time, without notice.

All ST products are sold pursuant to ST's terms and conditions of sale.

Purchasers are solely responsible for the choice, selection and use of the ST products and services described herein, and ST assumes no liability whatsoever relating to the choice, selection or use of the ST products and services described herein.

No license, express or implied, by estoppel or otherwise, to any intellectual property rights is granted under this document. If any part of this document refers to any third party products or services it shall not be deemed a license grant by ST for the use of such third party products or services, or any intellectual property contained therein or considered as a warranty covering the use in any manner whatsoever of such third party products or services or any intellectual property contained therein.

**UNLESS OTHERWISE SET FORTH IN ST'S TERMS AND CONDITIONS OF SALE ST DISCLAIMS ANY EXPRESS OR IMPLIED WARRANTY WITH RESPECT TO THE USE AND/OR SALE OF ST PRODUCTS INCLUDING WITHOUT LIMITATION IMPLIED WARRANTIES OF MERCHANTABILITY, FITNESS FOR A PARTICULAR PURPOSE (AND THEIR EQUIVALENTS UNDER THE LAWS OF ANY JURISDICTION), OR INFRINGEMENT OF ANY PATENT, COPYRIGHT OR OTHER INTELLECTUAL PROPERTY RIGHT.**

**UNLESS EXPRESSLY APPROVED IN WRITING BY AN AUTHORIZED ST REPRESENTATIVE, ST PRODUCTS ARE NOT RECOMMENDED, AUTHORIZED OR WARRANTED FOR USE IN MILITARY, AIR CRAFT, SPACE, LIFE SAVING, OR LIFE SUSTAINING APPLICATIONS, NOR IN PRODUCTS OR SYSTEMS WHERE FAILURE OR MALFUNCTION MAY RESULT IN PERSONAL INJURY, DEATH, OR SEVERE PROPERTY OR ENVIRONMENTAL DAMAGE. ST PRODUCTS WHICH ARE NOT SPECIFIED AS "AUTOMOTIVE GRADE" MAY ONLY BE USED IN AUTOMOTIVE APPLICATIONS AT USER'S OWN RISK.**

Resale of ST products with provisions different from the statements and/or technical features set forth in this document shall immediately void any warranty granted by ST for the ST product or service described herein and shall not create or extend in any manner whatsoever, any liability of ST.

ST and the ST logo are trademarks or registered trademarks of ST in various countries.

Information in this document supersedes and replaces all information previously supplied.

The ST logo is a registered trademark of STMicroelectronics. All other names are the property of their respective owners.

© 2010 STMicroelectronics - All rights reserved

STMicroelectronics group of companies

Australia - Belgium - Brazil - Canada - China - Czech Republic - Finland - France - Germany - Hong Kong - India - Israel - Italy - Japan - Malaysia - Malta - Morocco - Philippines - Singapore - Spain - Sweden - Switzerland - United Kingdom - United States of America

[www.st.com](http://www.st.com)