



Spartan

MA600.A.ABC.007

Specification

Part No.	MA600.A.ABC.007
Product Name	Spartan MA600 Spartan Screw Mount 3in1 Combination Antenna - GPS/GLONASS: 1575~1602MHz - Cellular: GSM/CDMA/HSPA/UMTS 2.4GHz / 5GHz
Feature	High performance outdoor antenna Custom cables and connectors available RoHS Compliant

1. Introduction

The Spartan MA.600 antenna is a heavy-duty, fully IP67 waterproof external M2M antenna for use in telematics, transportation and remote monitoring applications.

The Spartan is unique in the market because it combines a 3in1 GPS/GLONASS, Cellular (2G and 3G) and Wi-Fi, heavy-duty antenna with high efficiency in a compact format. The antenna screws down permanently onto a roof or metal panel and can be pole or wall-mounted with a metal bracket.

For industries such as commercial vehicle telematics, remote monitoring, smart meter systems and construction equipment, the Spartan provides a robust, rugged antenna that is durable, even in extreme environments.

All while still maintaining 20dB isolation between antennas. It uses high-shielded PTFE dielectric ultra low-loss cables that maintain low attenuation at all frequency bands, with an average 0.3dB per meter (0.1dB per foot), compared to 0.7dB for RG58 and 1.2dB for RG174.

Because of this, the Spartan maximizes chances of passing PTCRB and network approvals first time. The Spartan also has excellent GPS/GLONASS reception without need to attach to an external ground-plane due to coupling to its unique own metal base.

Note: for ground-isolation antennas use the MA.605 version with Isolation Gaskets.

2. Specification

GPS-GLONASS

Centre Frequency	1575.42MHz / 1602MHz
Bandwidth	10MHz
Radiation Efficiency	50 (without cable)
Passive Gain @ Zenith	4.0 typ (with $\psi = 140\text{mm}$ ground)
VSWR	2
Impedance	50 Ω
DC Power Input Range	3 ~ 5V

DC input	3.3V		4.0V		5.5V	
	1575.42	1602	1575.42	1602	1575.42	1602
MHz						
VSWR	2	2	2	2	2	2
LNA Gain	29.2	29	31	31	32.3	32
Noise Figure	3.1	3.1	3.2	3.2	3.4	3.4
Power Consumption	7.5	7.5	9.4	9.4	15	15
Band Attenuation	1520MHz: -20dB		1520MHz: -20dB		1520MHz: -20dB	
	1642MHz: -20dB		1642MHz: -20dB		1642MHz: -20dB	

Cable	3M RG-174 standard, fully customizable
Connector	SMA(M) standard, fully customizable

2. Specification

Cellular

Frequency (GHz)	824 ~ 896	880 ~ 960	1710 ~ 1880	1850 ~ 1990	1710 ~ 2170
Peak Gain (dBi)	2.1	-0.2	2.9	3.0	5.1
Average (dBi)	-4.7	-7.5	-2.7	-3.1	-3.1
Efficiency	35%	20%	51%	49%	49%
Impedance	50Ω				
Polarization	Linear				
Radiation Pattern	Omni				
Cable	3M CFD200 standard, fully customizable				
Connector	SMA(M) standard, fully customizable				

WIFI

Frequency (GHz)	2.4 ~ 2.5	4.7 ~ 5.0	5.0 ~ 5.4	5.4 ~ 5.9
Peak Gain (dBi)	2.1	2.9	3.8	2.8
Average Gain (dBi)	-2.3	-3.6	-3.3	-3.8
Efficiency	60%	44%	46%	42%
VSWR	<=1.6:1			
Impedance	50Ω			
Polarization	Linear			
Radiation Pattern	Omni			
Cable	3M CFD200 standard, fully customizable			
Connector	RP-SMA(M) standard, standard, fully customizable			

Mechanical

Dimensions	Profile 39.5mm x Diameter 145.6mm
Casing	Wonderloy PC-540 PC/ABS Alloy
Base and thread	Nickel Plated Zinc
Thread diameter	30mm
Waterproof	IP67

Environmental

Temperature Range	-40°C to 85°C
Humidity	Non-condensing 65°C 95% RH

* All measurements are done in free space with standard cables.

3. GPS/GLONASS Antenna Characteristics

3.1 Block Diagram

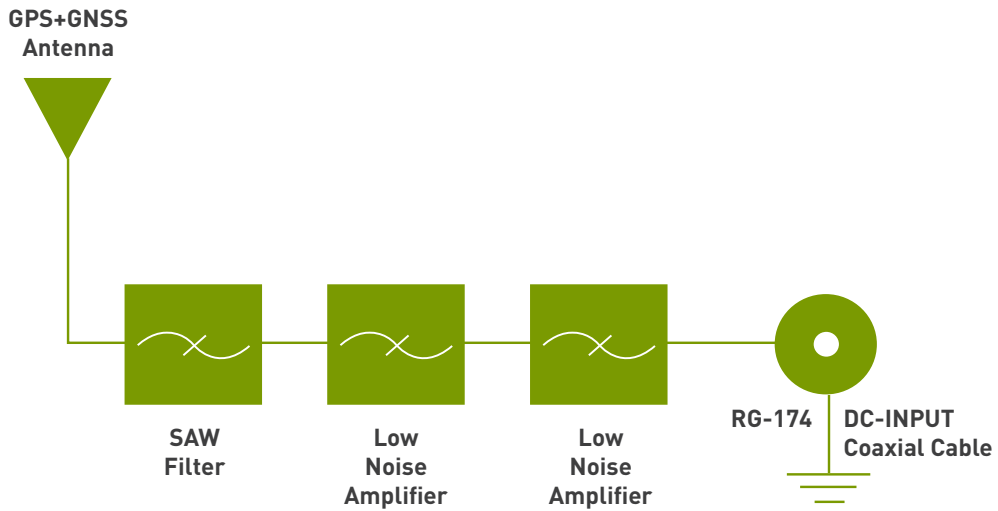

3.2 Return Loss

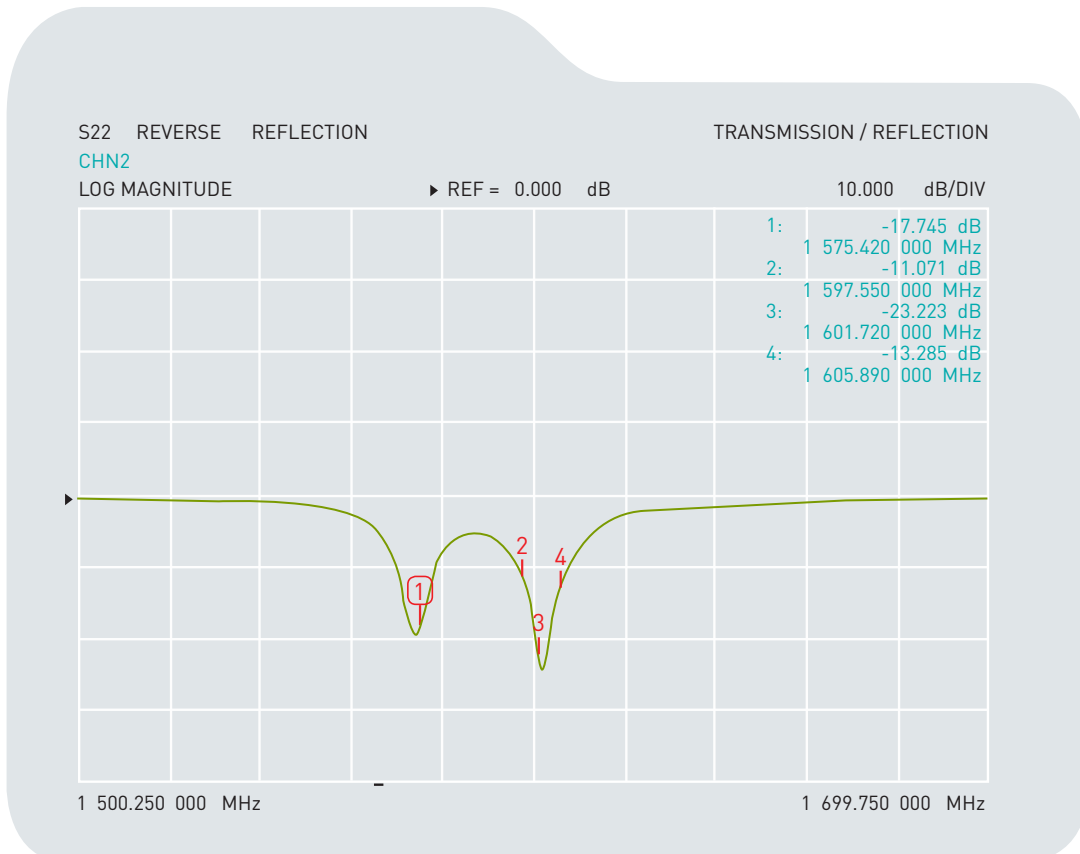

3.3 GPS/GLONASS Antenna Radiation Pattern

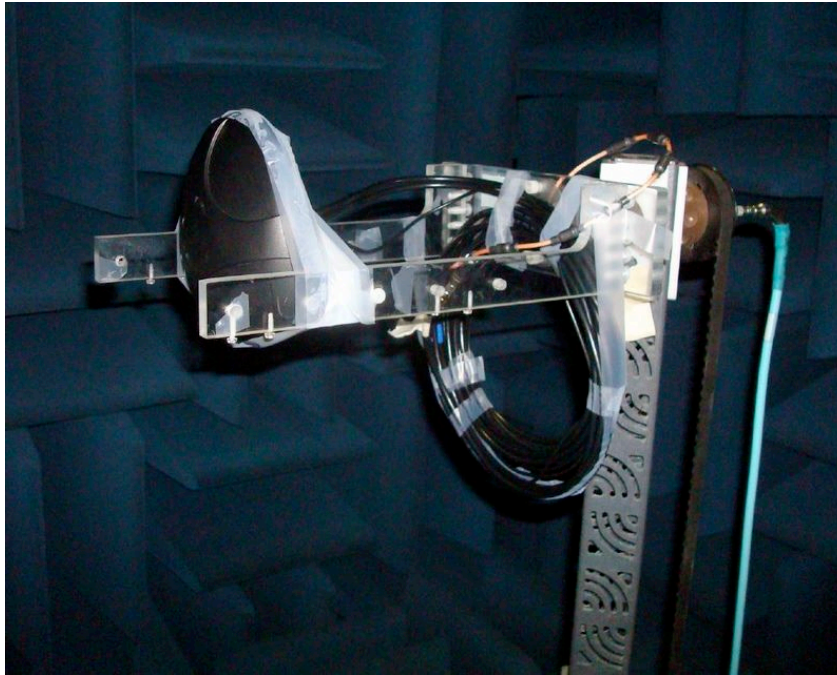

MA.600 tested in CTIA approved 3D chamber

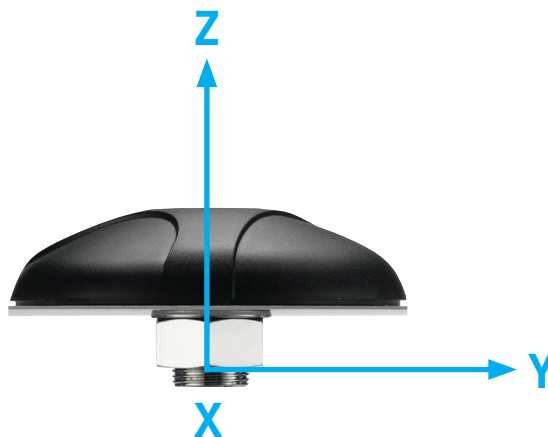

XYZ co-ordinate for reference

3.4 Radiation Pattern

XZ-plane Free Space @1575.42MHz

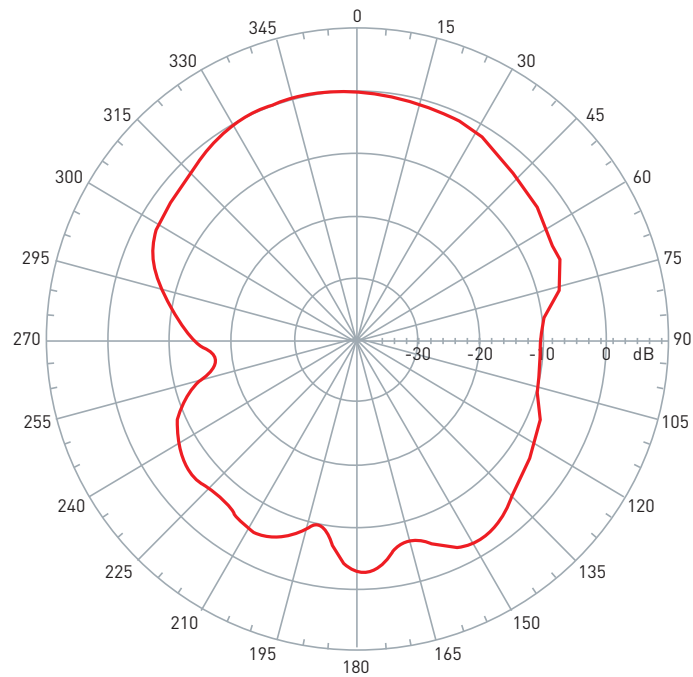

YZ-plane Free Space @1575.42MHz

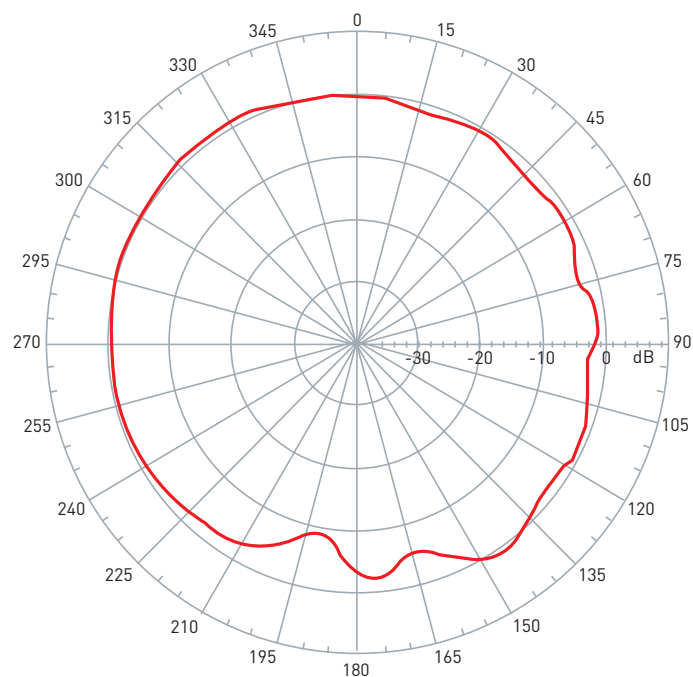

3.4 Radiation Pattern

XZ-plane Free Space @1602MHz

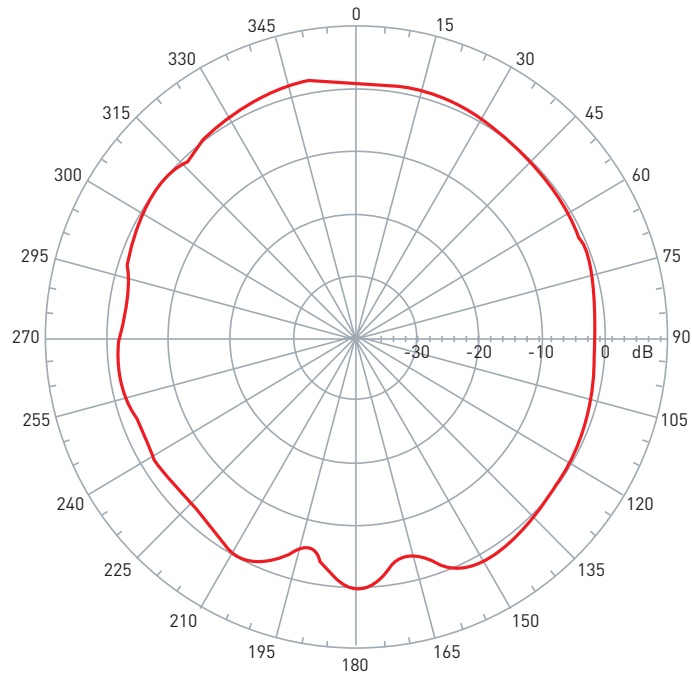

YZ-plane Free Space @1602MHz

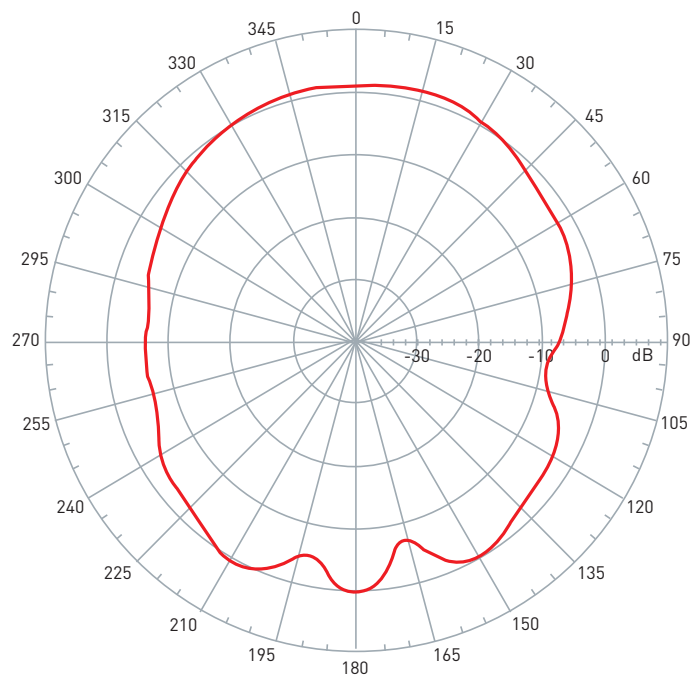

3.5 GPS/GLONASS LNA

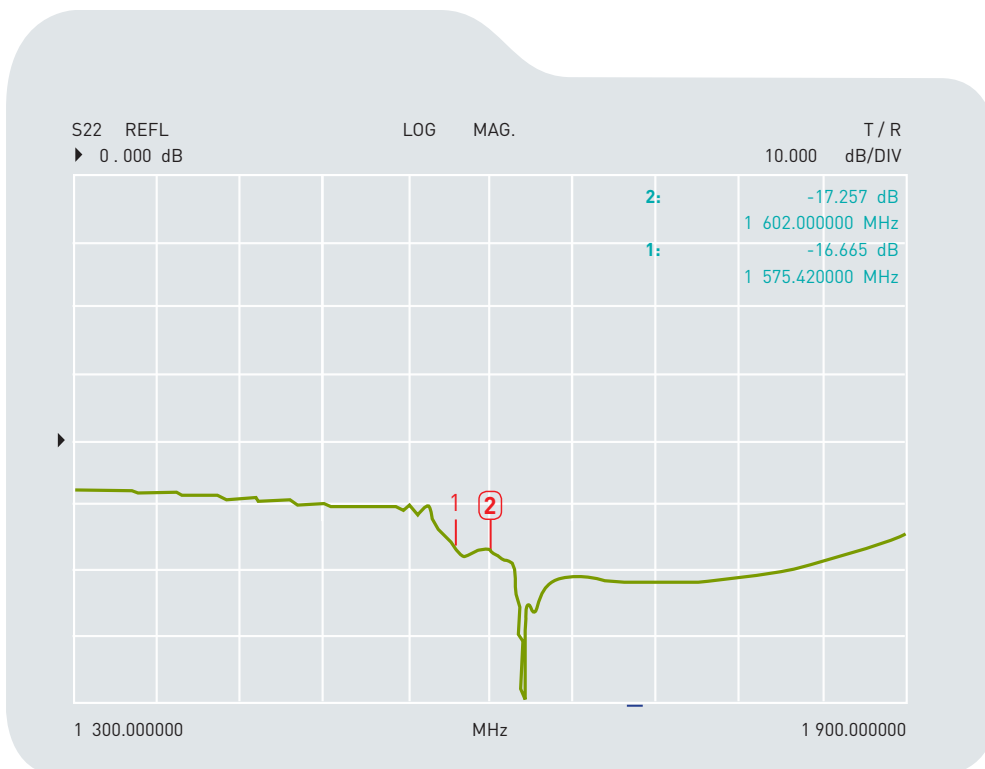
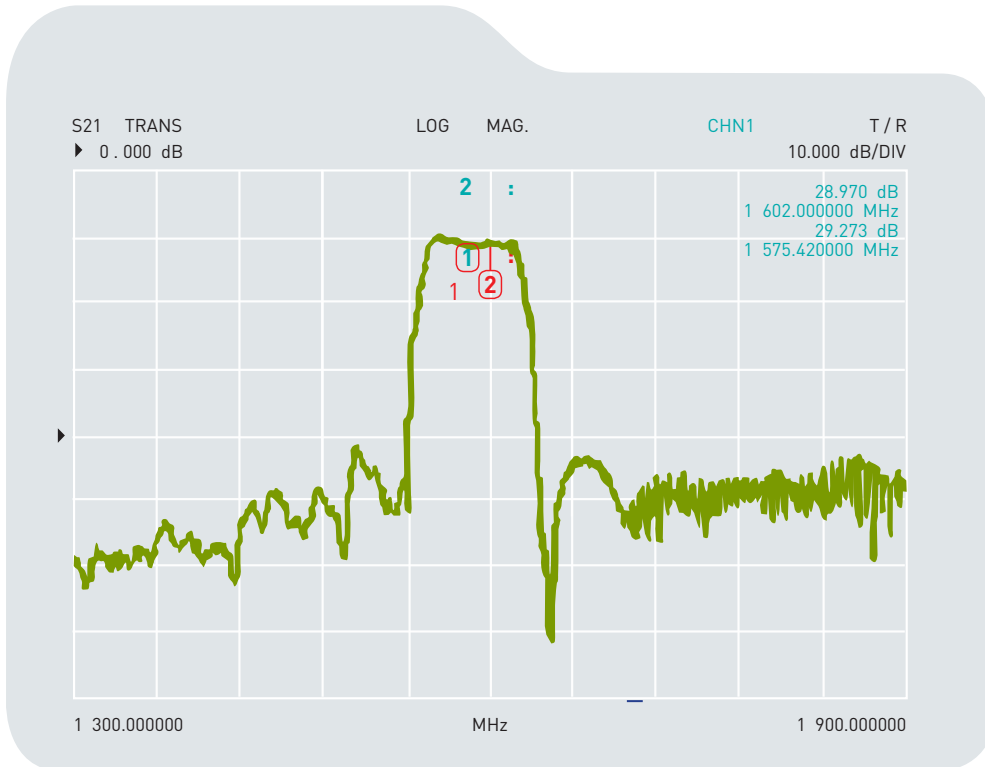

4. Cellular Antenna Characteristics

4.1 Return Loss

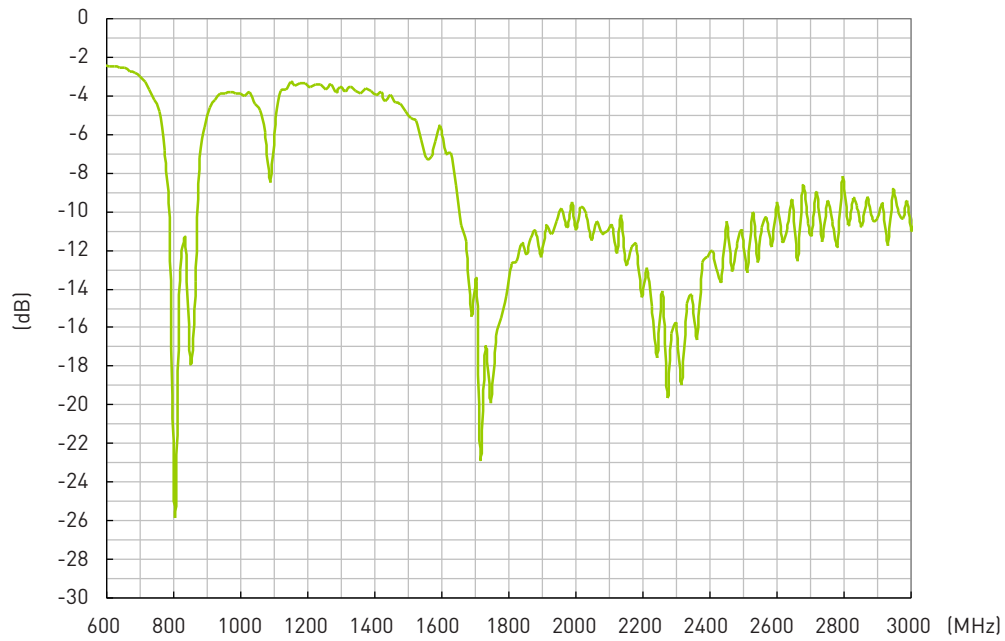

4.2 VSWR

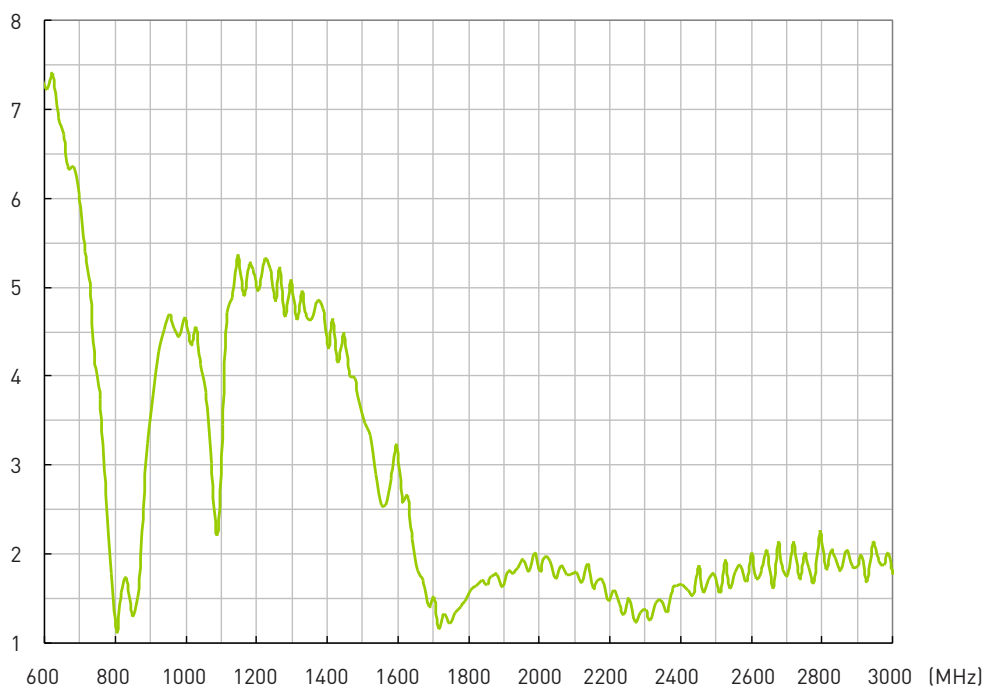

4. Cellular Antenna Characteristics

4.3 Cellular Antenna Efficiency

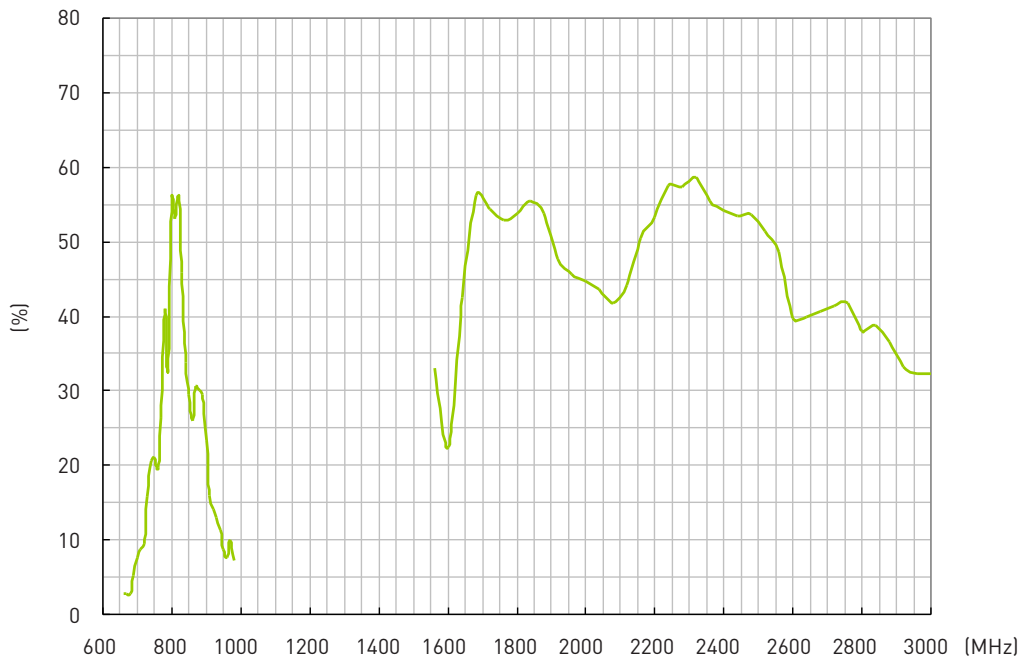

4.4 Cellular Antenna Peak Gain

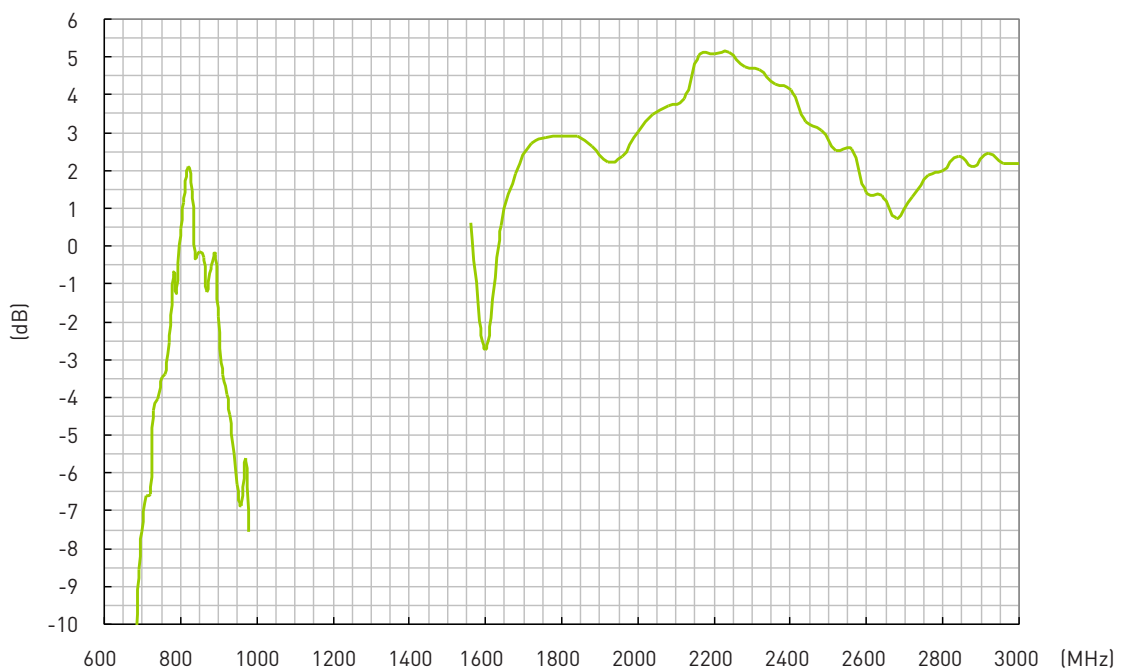

4.5 Cellular Antenna 3D Average Gain

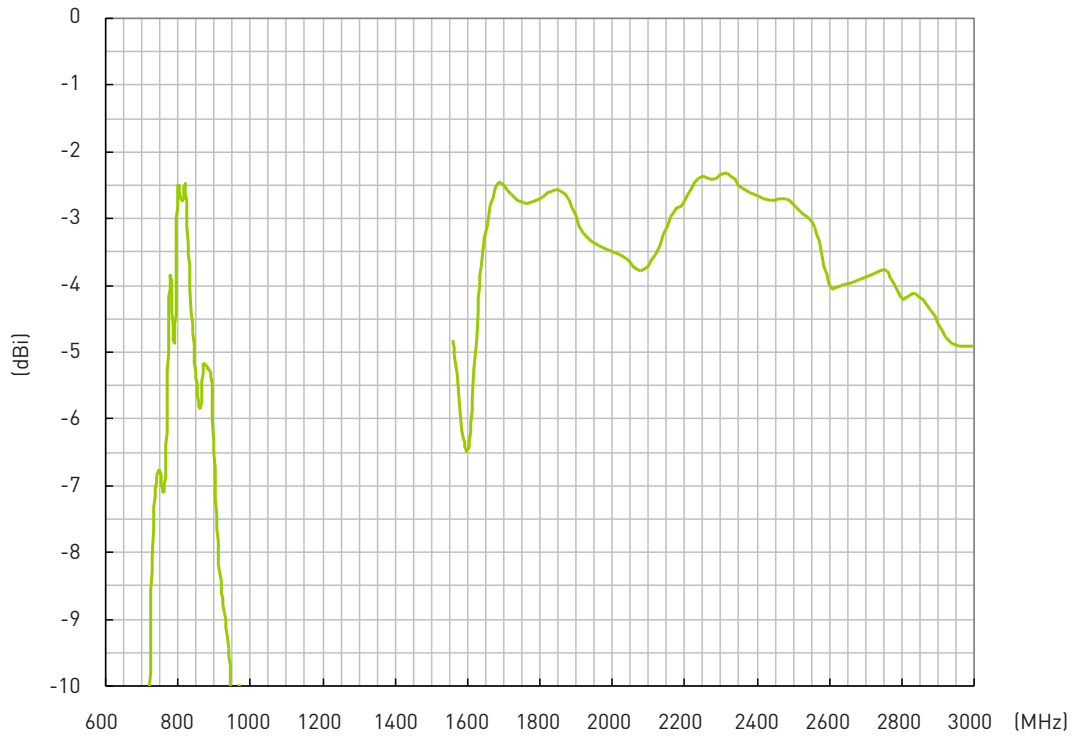

5. Cellular Antenna Radiation Pattern

5.1 XY-Plane

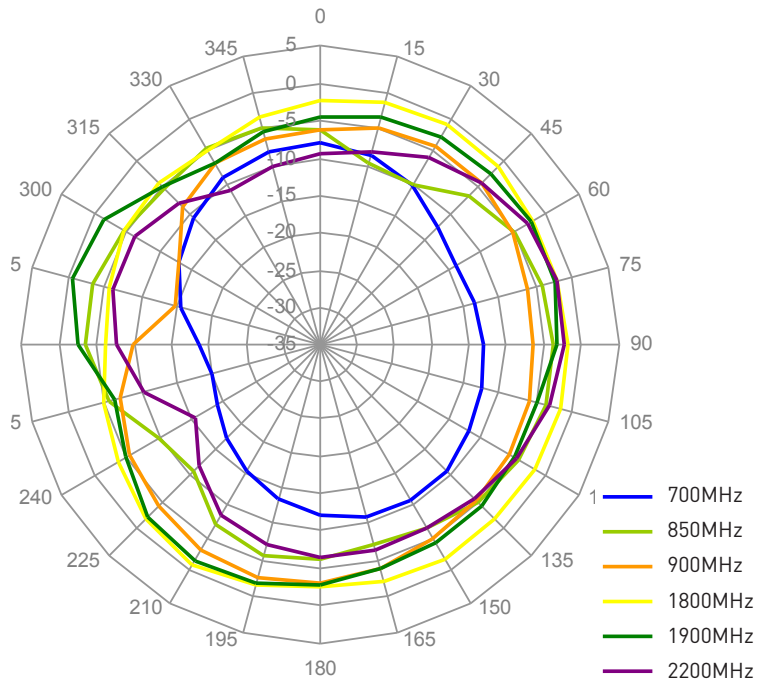

5.2 XZ-Plane

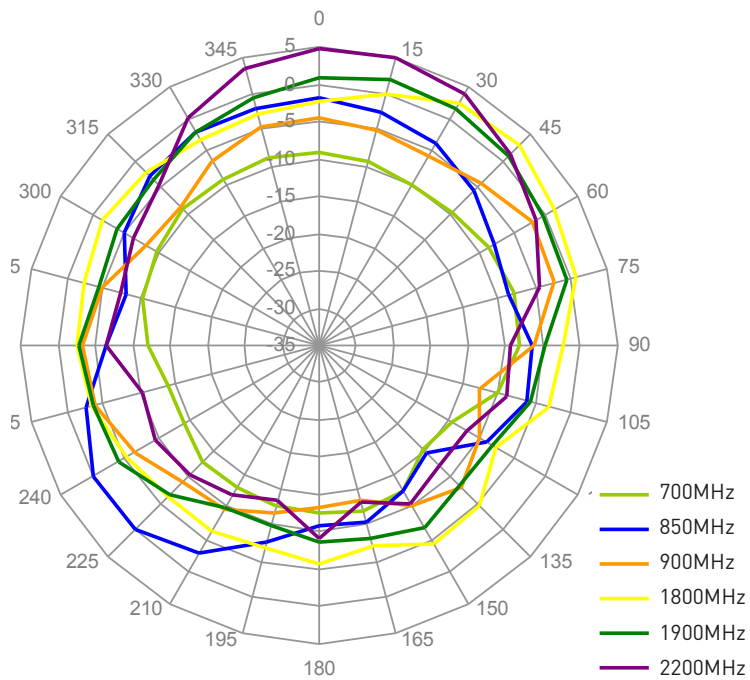

6. 2.4/5GHz Antenna Characteristics

6.1 S11 Return Loss

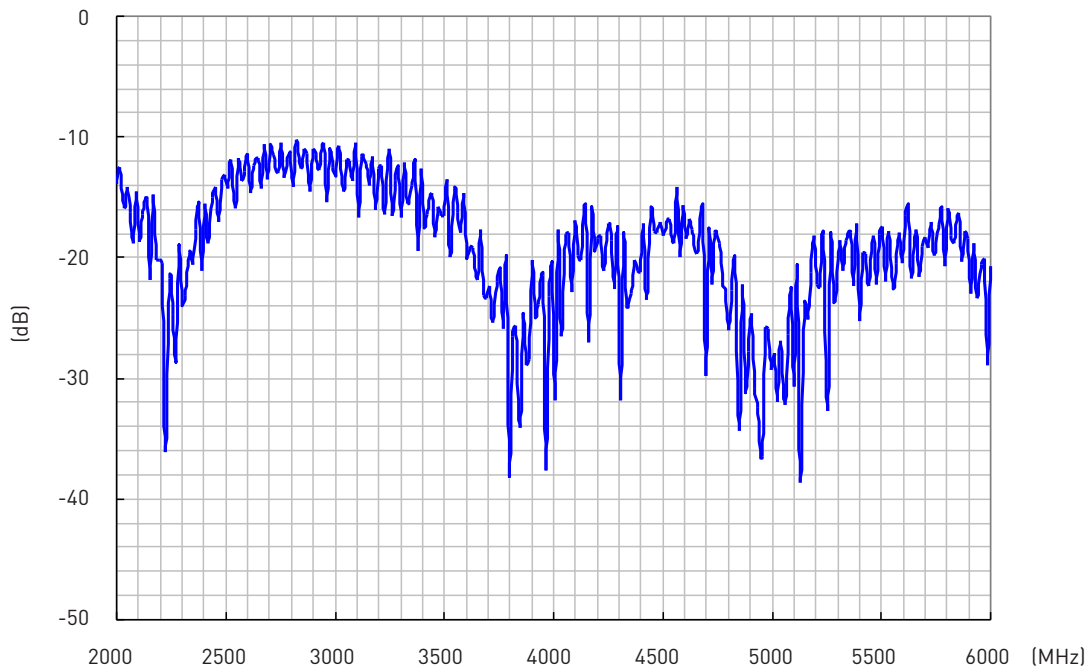

6.2 VSWR

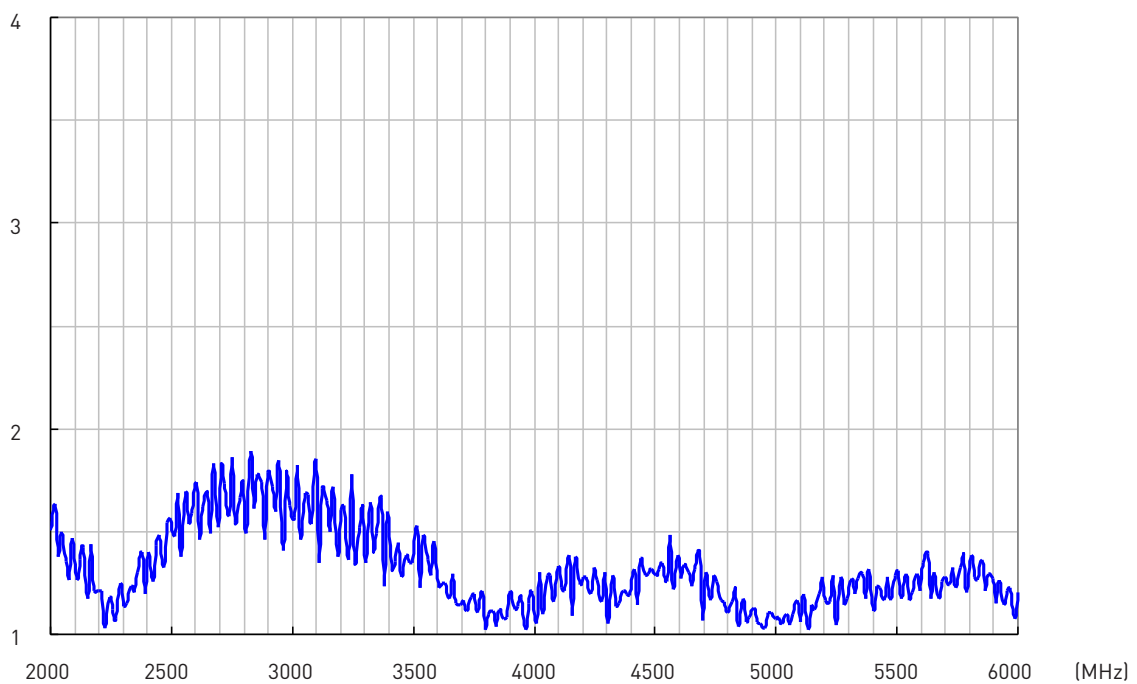

6.3 2.4/5GHz Antenna Efficiency

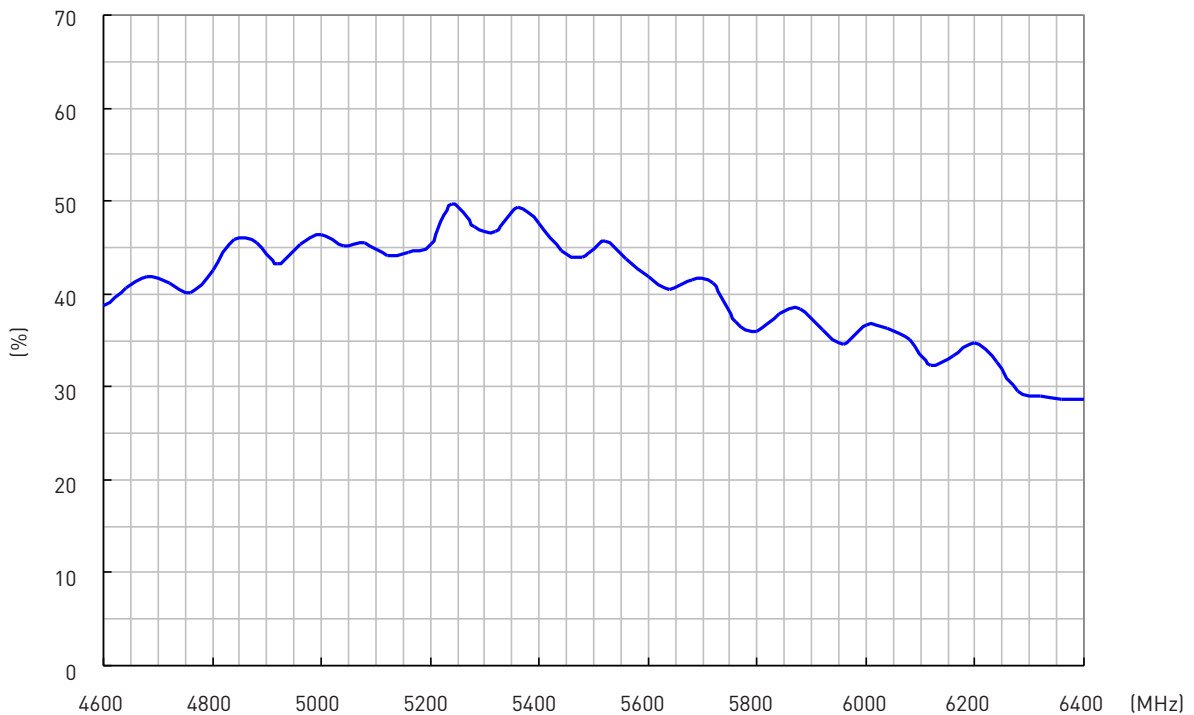
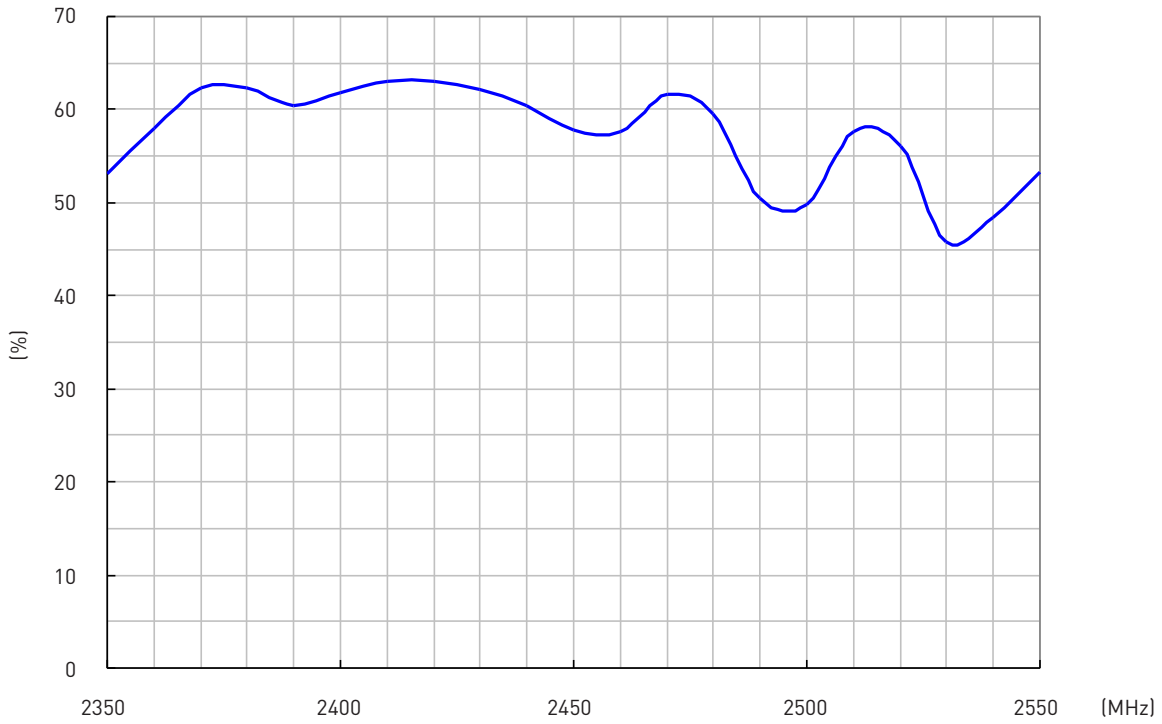

6.4 2.4/5GHz Antenna Peak Gain

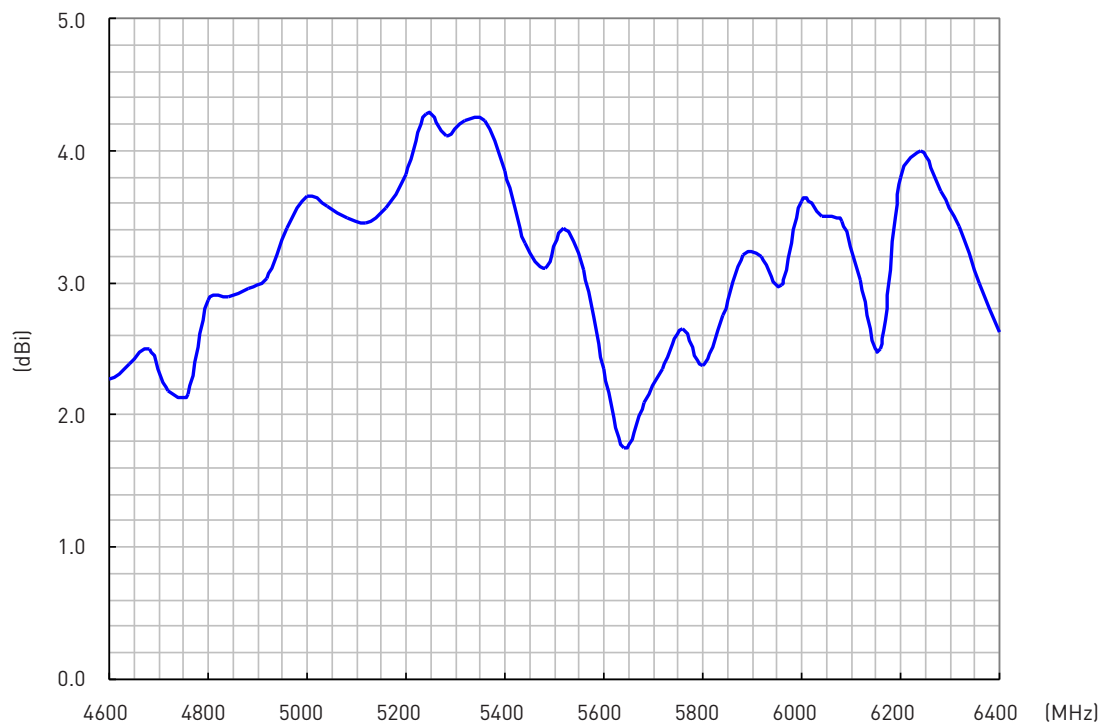
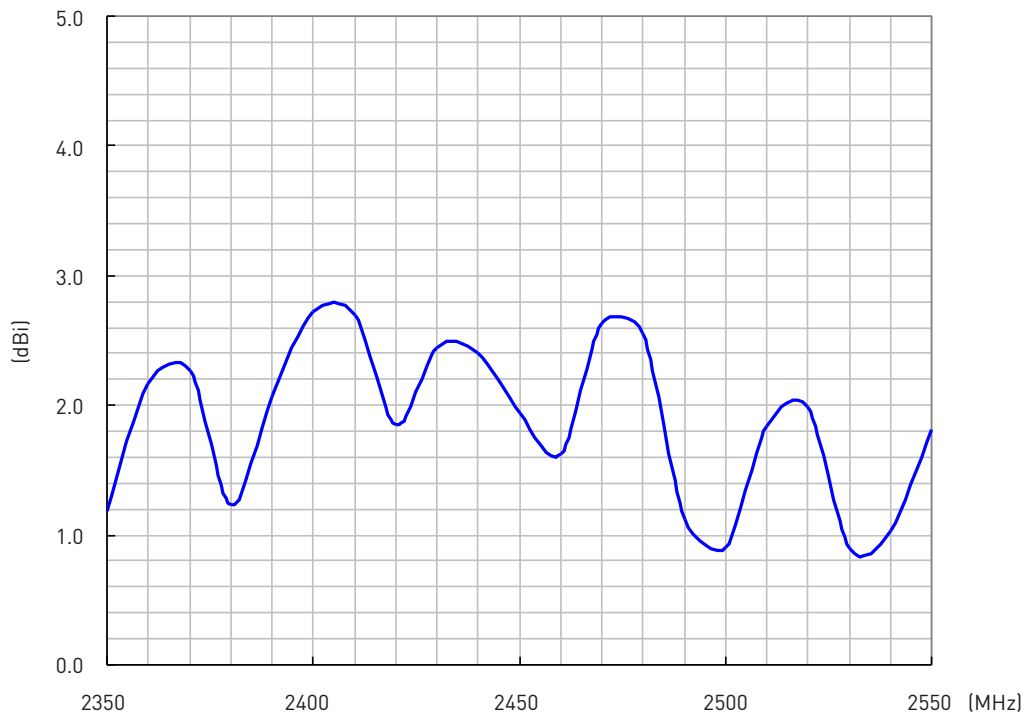

6.5 2.4/5GHz Antenna Peak Gain

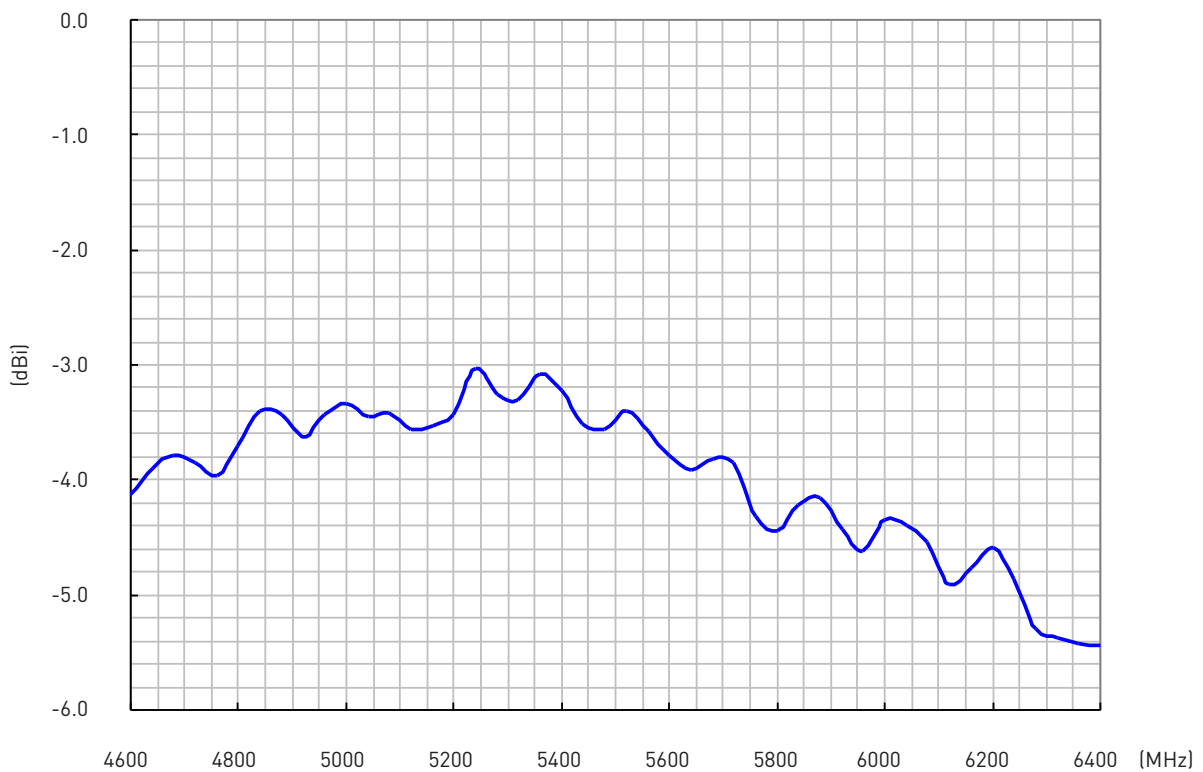
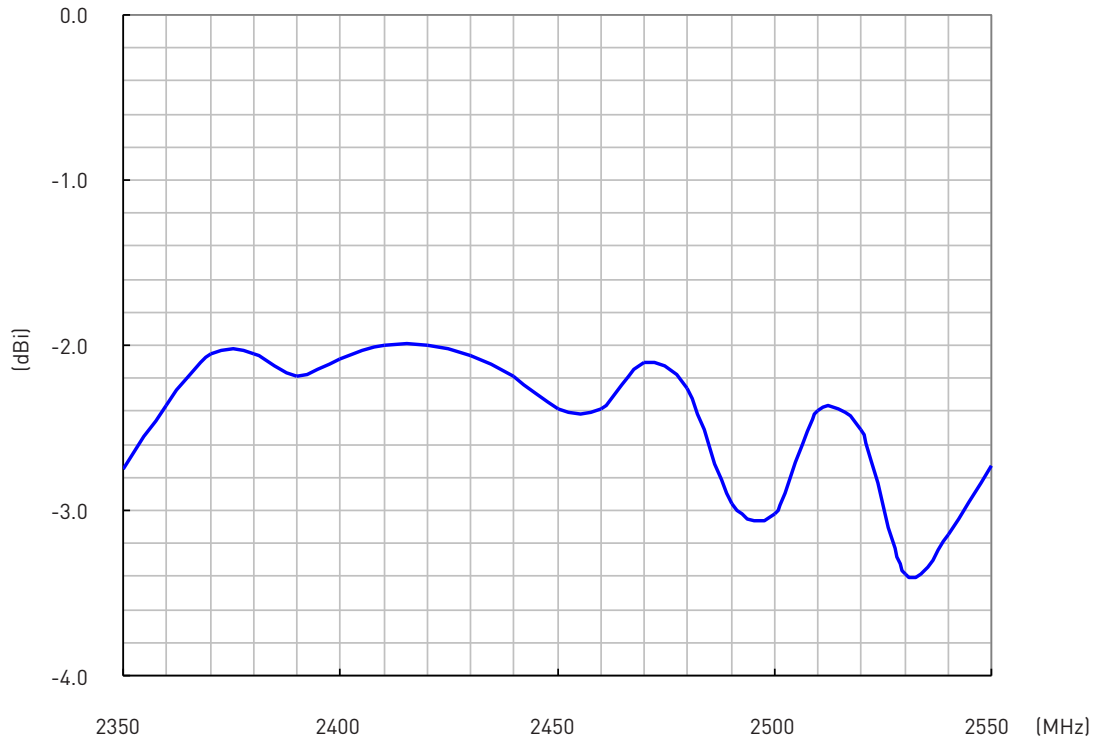

7. 2.4/5GHz Antenna Radiation Pattern

7.1 XY-Plane

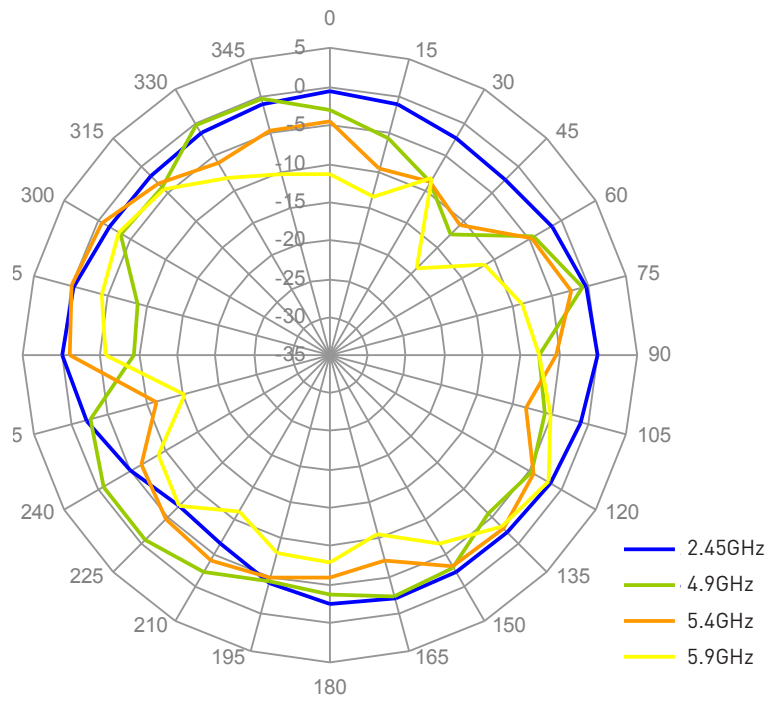

7.2 XZ-Plane

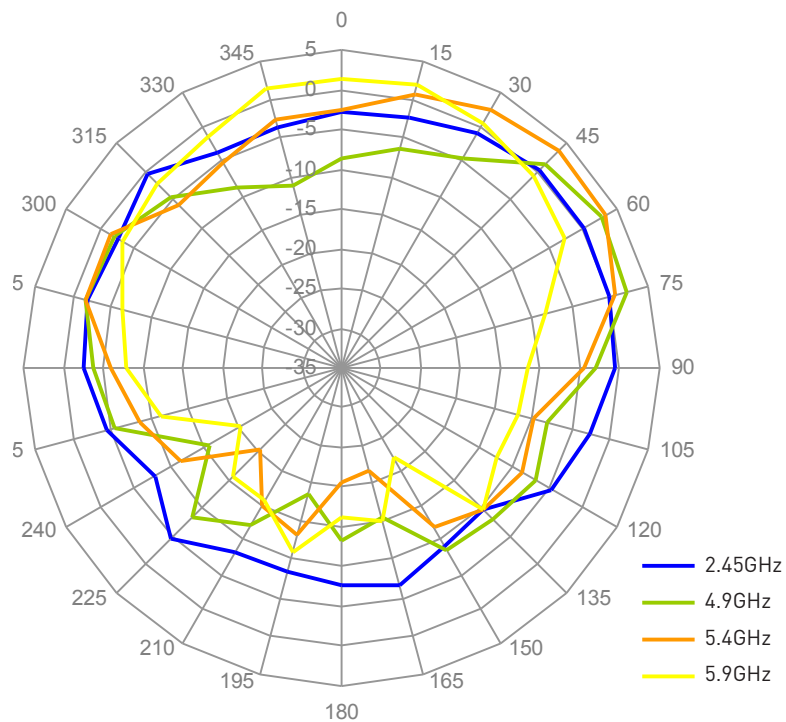

8. Mechanical Drawing

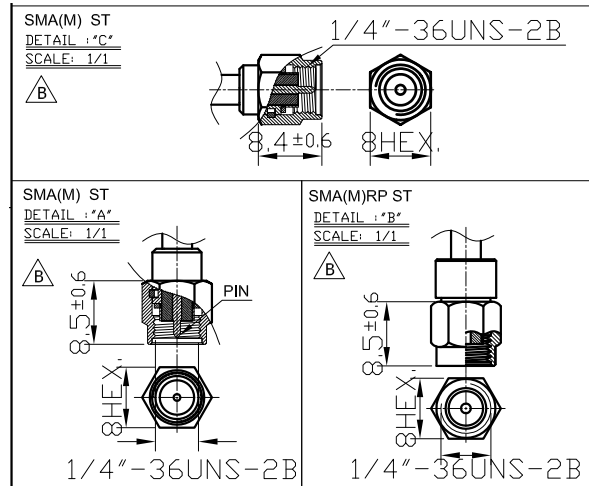
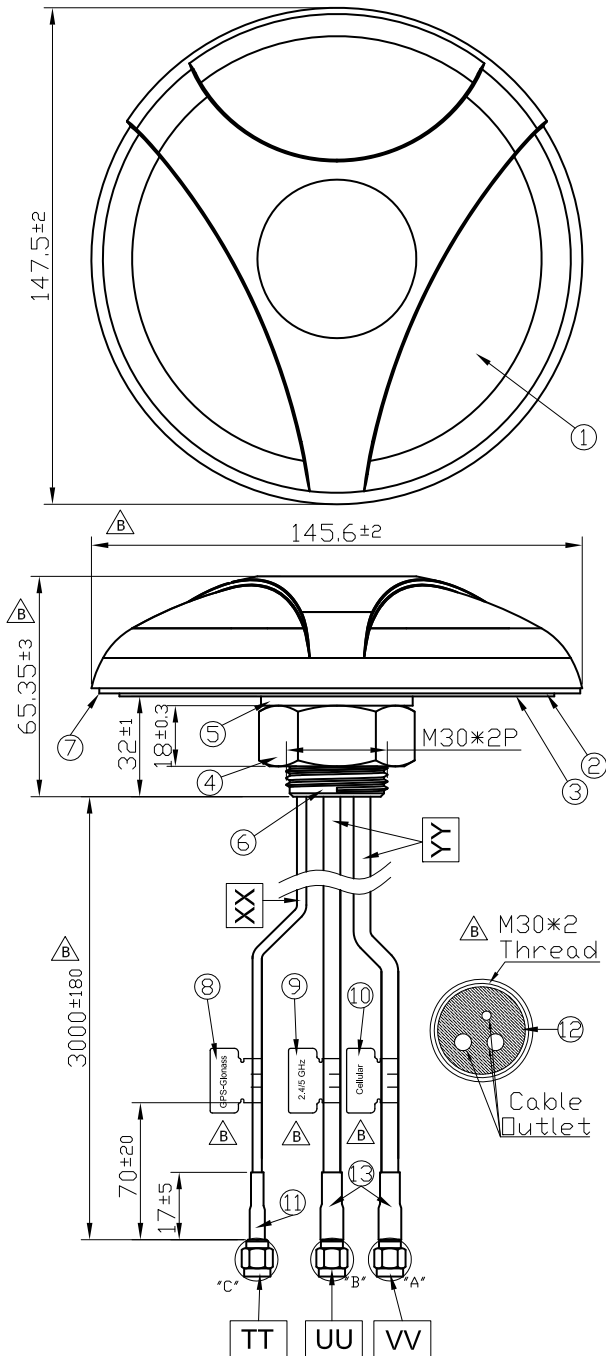

	Name	Material	Finish	QTY
1	Housing	PC 540	Black	1
2	Closed Cell Foam	CR 4305	Black	1
3	3M Double Adhesive	3M 9448 HK	White Liner	1
4	M30 Nut	Steel AISI 1215	Ni Plated	1
5	Washer	Steel AISI 1215	Ni Plated	1
6	M30x 2 Thread 32L	Zinc Alloy	Ni Plated	1
7	Waterproof Rubber	Silicon	Black	1
8	GPS-Glonass Label	Coated Paper	Orange	1
9	2.4GHz/5GHz Label	Coated Paper	Green	1
10	Cellular Label	Coated Paper	Blue	1
11	Heat Shrink Tube (RG-174)	PE	Black	1
12	Rubber Stopper	Silicon Rubber	Black	1
13	Heat Shrink Tube (CFD-200)	PE	Black	2

	Name	Spec	Finish	QTY
TT	Connector Type	SMA(M) ST	Gold	1
UU	Connector Type	SMA(M)RP ST	Gold	1
VV	Connector Type	SMA(M) ST	Gold	1
XX	Cable Type	RG174	Black	1
YY	Cable Type	CFD 200	Black	2

8. Mechanical Drawing

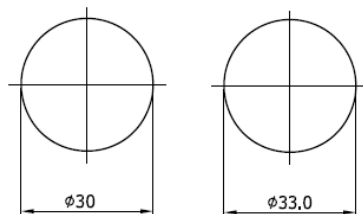
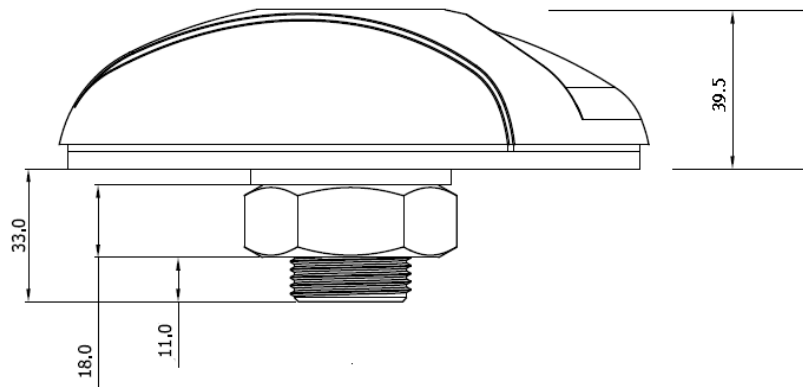
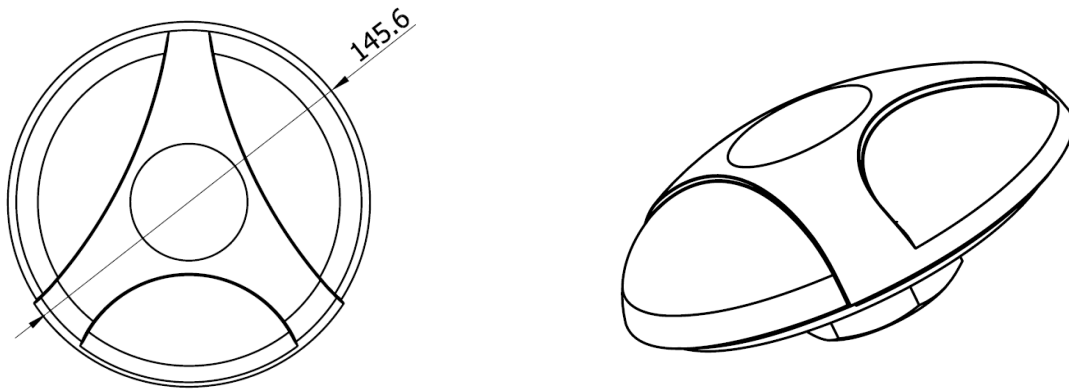

**Thread
Diameter**

**Recommended
Mounting Hole**

Unit: mm

9. Installation

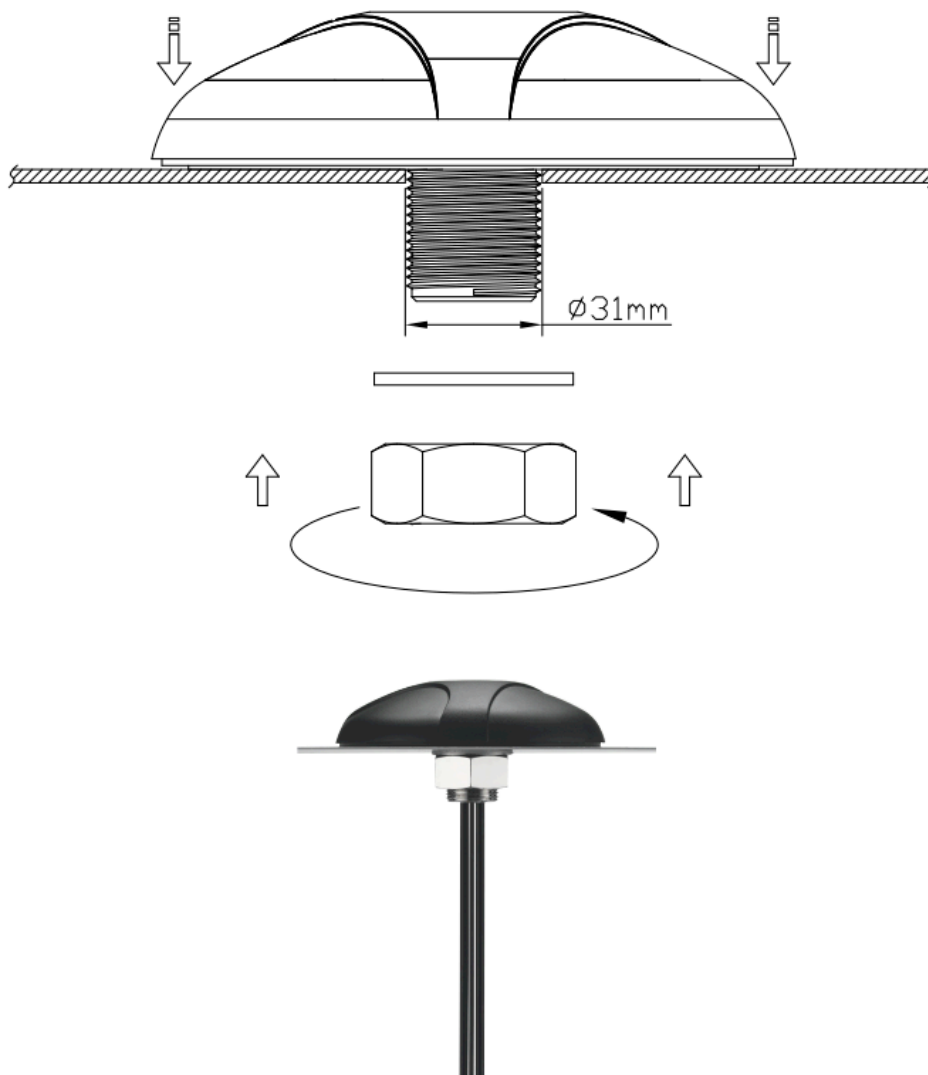

10. Packaging

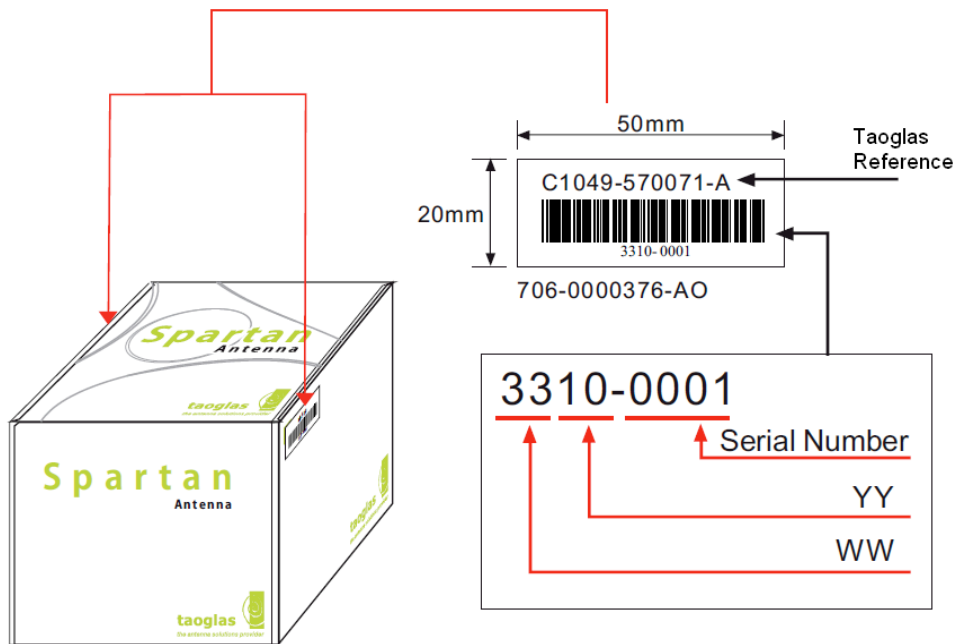
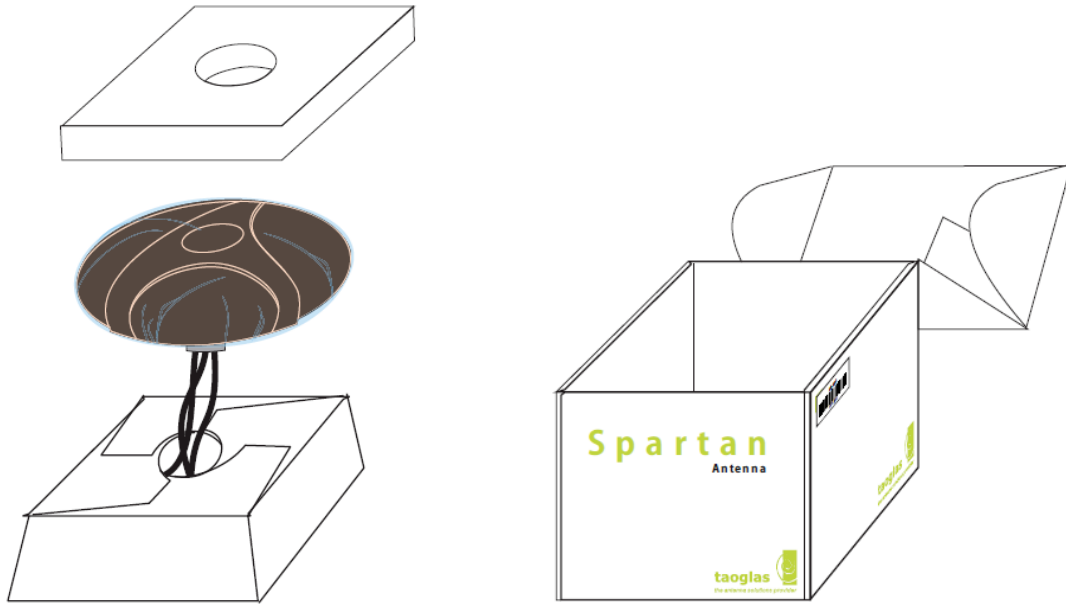

8 boxes per carton

10. Packaging

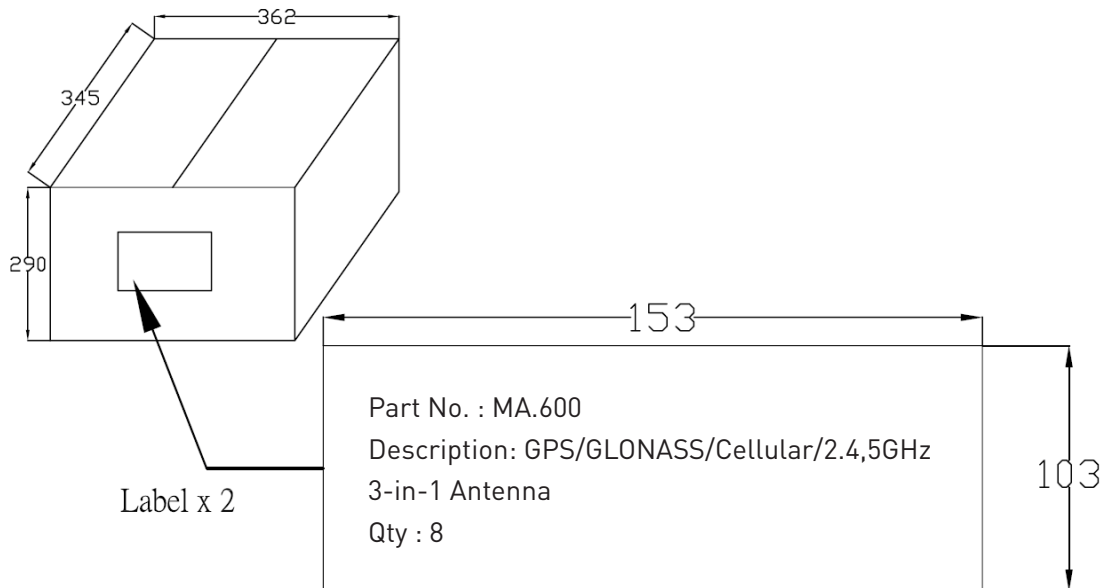

Taoglas makes no warranties based on the accuracy or completeness of the contents of this document and reserves the right to make changes to specifications and

product descriptions at any time without notice. Taoglas reserves all rights to this document and the information contained herein.

Reproduction, use or disclosure to third parties without express permission is strictly prohibited.
Copyright © Taoglas Ltd.