

NLX3G17

Triple Non-Inverting Schmitt-Trigger Buffer

The NLX3G17 MiniGate™ is an advanced high-speed CMOS triple non-inverting Schmitt-trigger buffer in ultra-small footprint.

The NLX3G17 input and output structures provide protection when voltages up to 7.0 V are applied, regardless of the supply voltage.

The NLX3G17 can be used to enhance noise immunity or to square up slowly changing waveforms.

Features

- Designed for 1.65 V to 5.5 V V_{CC} Operation
- Low Power Dissipation: $I_{CC} = 1 \mu A$ (Max) at $T_A = 25^\circ C$
- 24 mA Balanced Output Source and Sink Capability @ $V_{CC} = 3.0 V$
- Balanced Propagation Delays
- Overvoltage Tolerant (OVT) Input and Output Pins
- Ultra-Small Packages
- These are Pb-Free Devices

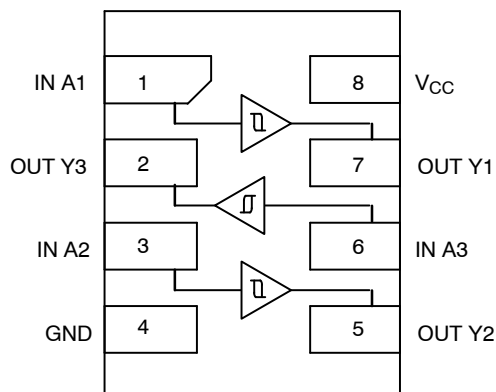

Figure 1. Pinout (Top View)

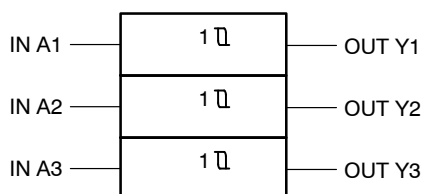

Figure 2. Logic Symbol

FUNCTION TABLE	
A	Y
L	L
H	H

PIN ASSIGNMENT

1	IN A1
2	OUT Y3
3	IN A2
4	GND
5	OUT Y2
6	IN A3
7	OUT Y1
8	V_{CC}



ON Semiconductor®

<http://onsemi.com>

MARKING DIAGRAMS



ULLGA8
1.45 x 1.0
CASE 613AA

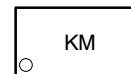

ULLGA8
1.6 x 1.0
CASE 613AB

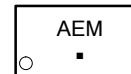

ULLGA8
1.95 x 1.0
CASE 613AC

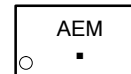

UDFN8
1.45 x 1.0
CASE 517BZ

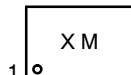

UDFN8
1.6 x 1.0
CASE 517BY

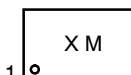

UDFN8
1.95 x 1.0
CASE 517CA

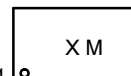

K or AE = Specific Device Code

M = Date Code

▪ = Pb-Free Package

ORDERING INFORMATION

See detailed ordering and shipping information in the package dimensions section on page 5 of this data sheet.

NLX3G17

MAXIMUM RATINGS

Symbol	Parameter	Value	Unit
V _{CC}	DC Supply Voltage	-0.5 to +7.0	V
V _{IN}	DC Input Voltage	-0.5 to +7.0	V
V _{OUT}	DC Output Voltage	-0.5 to +7.0	V
I _{IK}	DC Input Diode Current V _{IN} < GND	-50	mA
I _{OK}	DC Output Diode Current V _{OUT} < GND	-50	mA
I _O	DC Output Source/Sink Current	±50	mA
I _{CC}	DC Supply Current Per Supply Pin	±100	mA
I _{GND}	DC Ground Current per Ground Pin	±100	mA
T _{STG}	Storage Temperature Range	-65 to +150	°C
T _L	Lead Temperature, 1 mm from Case for 10 Seconds	260	°C
T _J	Junction Temperature Under Bias	150	°C
MSL	Moisture Sensitivity	Level 1	
F _R	Flammability Rating Oxygen Index: 28 to 34	UL 94 V-0 @ 0.125 in	
I _{LATCHUP}	Latchup Performance Above V _{CC} and Below GND at 125 °C (Note 5)	±500	mA

Stresses exceeding Maximum Ratings may damage the device. Maximum Ratings are stress ratings only. Functional operation above the Recommended Operating Conditions is not implied. Extended exposure to stresses above the Recommended Operating Conditions may affect device reliability.

1. Measured with minimum pad spacing on an FR4 board, using 10 mm-by-1 inch, 2 ounce copper trace no air flow.
2. Tested to EIA/JESD22-A114-A.
3. Tested to EIA/UESD22-A115-A.
4. Tested to JESD22-C101-A.
5. Tested to EIA / JESD78.

RECOMMENDED OPERATING CONDITIONS

Symbol	Parameter	Min	Max	Unit
V _{CC}	Positive DC Supply Voltage	1.65	5.5	V
V _{IN}	Digital Input Voltage	0	5.5	V
V _{OUT}	Output Voltage	0	5.5	V
T _A	Operating Free-Air Temperature	-55	+125	°C
Δt/ΔV	Input Transition Rise or Fall Rate V _{CC} = 2.5 V ± 0.2 V V _{CC} = 3.3 V ± 0.3 V V _{CC} = 5.0 V ± 0.5 V	0	No Limit	ns/V
		0	No Limit	
		0	No Limit	

NLX3G17

DC ELECTRICAL CHARACTERISTICS

Symbol	Parameter	Conditions	V _{CC} (V)	T _A = 25 °C			T _A = +85°C		T _A = -55°C to +125°C		Unit
				Min	Typ	Max	Min	Max	Min	Max	
V _{T+}	Positive Threshold Voltage		1.65	0.6	1.0	1.4	0.6	1.4	0.6	1.4	V
			2.3	1.0	1.5	1.8	1.0	1.8	1.0	1.8	
			2.7	1.2	1.7	2.0	1.2	2.0	1.2	2.0	
			3.0	1.3	1.9	2.2	1.3	2.2	1.3	2.2	
			4.5	1.9	2.7	3.1	1.9	3.1	1.9	3.1	
			5.5	2.2	3.3	3.6	2.2	3.6	2.2	3.6	
V _{T-}	Negative Threshold Voltage		1.65	0.2	0.5	0.8	0.2	0.8	0.2	0.8	V
			2.3	0.4	0.75	1.15	0.4	1.15	0.4	1.15	
			2.7	0.5	0.87	1.4	0.5	1.4	0.5	1.4	
			3.0	0.6	1.0	1.5	0.6	1.5	0.6	1.5	
			4.5	1.0	1.5	2.0	1.0	2.0	1.0	2.0	
			5.5	1.2	1.9	2.3	1.2	2.3	1.2	2.3	
V _H	Low-Level Input Voltage		1.65	0.1	0.48	0.9	0.1	0.9	0.1	0.9	V
			2.3	0.25	0.75	1.1	0.25	1.1	0.25	1.1	
			2.7	0.3	0.83	1.15	0.3	1.15	0.3	1.15	
			3.0	0.4	0.93	1.2	0.4	1.2	0.4	1.2	
			4.5	0.6	1.2	1.5	0.6	1.5	0.6	1.5	
			5.5	0.7	1.4	1.7	0.7	1.7	0.7	1.7	
V _{OH}	High-Level Output Voltage	V _{IN} ≥ V _{T+MAX} I _{OH} = -100 μA	1.65 – 5.5	V _{CC} – 0.1	V _{CC}		V _{CC} – 0.1		V _{CC} – 0.1		V
		V _{IN} ≥ V _{T+MAX} I _{OH} = -4 mA	1.65	1.29	1.52		1.29		1.29		
		I _{OH} = -8 mA	2.3	1.9	2.1		1.9		1.8		
		I _{OH} = -12 mA	2.7	2.2	2.4		2.2		2.1		
		I _{OH} = -16 mA	3.0	2.4	2.7		2.4		2.3		
		I _{OH} = -24 mA	3.0	2.3	2.5		2.3		2.2		
V _{OL}	Low-Level Output Voltage	V _{IN} ≤ V _{T-MIN} I _{OL} = 100 μA	1.65 – 5.5		0	0.1		0.1		0.1	V
		V _{IN} ≤ V _{T-MIN} I _{OH} = 4 mA	1.65		0.08	0.24		0.24		0.24	
		I _{OH} = 8 mA	2.3		0.2	0.3		0.3		0.4	
		I _{OH} = 12 mA	2.7		0.22	0.4		0.4		0.5	
		I _{OH} = 16 mA	3.0		0.28	0.4		0.4		0.5	
		I _{OH} = 24 mA	3.0		0.38	0.55		0.55		0.55	
I _{IN}	Input Leakage Current	0 ≤ V _{IN} ≤ 5.5 V	0 to 5.5			±0.1		±1.0		±1.0	μA
I _{OFF}	Power-Off Output Leakage Current	V _{OUT} = 5.5 V	0			1.0		10		10	μA
I _{CC}	Quiescent Supply Current	0 ≤ V _{IN} ≤ V _{CC}	5.5			1.0		10		10	μA

NLX3G17

AC ELECTRICAL CHARACTERISTICS (Input $t_r = t_f = 3.0$ nS)

Symbol	Parameter	V_{CC} (V)	Test Condition	$T_A = 25^\circ\text{C}$			$T_A = +85^\circ\text{C}$		$T_A = -55^\circ\text{C to } +125^\circ\text{C}$		Unit
				Min	Typ	Max	Min	Max	Min	Max	
t_{PLH} , t_{PHL}	Propagation Delay Input A to Output	2.3 to 2.7	$R_L = 1\text{ M}\Omega$, $C_L = 15\text{ pF}$	1.8	4.3	7.4	1.8	8.1	1.8	9.1	ns
		3.0 to 3.6	$R_L = 1\text{ M}\Omega$, $C_L = 15\text{ pF}$	1.5	3.3	5.0	1.5	5.5	1.5	6.5	
			$R_L = 500\ \Omega$, $C_L = 50\text{ pF}$	1.8	4.0	5.0	1.8	6.6	1.8	7.6	
		4.5 to 5.5	$R_L = 1\text{ M}\Omega$, $C_L = 15\text{ pF}$	1.0	2.7	4.1	1.0	4.5	1.0	5.5	
			$R_L = 500\ \Omega$, $C_L = 50\text{ pF}$	1.2	3.2	4.9	1.2	5.4	1.2	6.4	
C_{IN}	Input Capacitance	5.5	$V_{IN} = 0\text{ V or } V_{CC}$		7.0						pF
C_{PD}	Power Dissipation Capacitance (Note 6)	3.3 5.5	10 MHz $V_{IN} = 0\text{ V or } V_{CC}$		9.0 11						pF

6. C_{PD} is defined as the value of the internal equivalent capacitance which is calculated from the dynamic operating current consumption without load. Average operating current can be obtained by the equation $I_{CC(OPR)} = C_{PD} \cdot V_{CC} \cdot f_{in} + I_{CC}$. C_{PD} is used to determine the no-load dynamic power consumption: $P_D = C_{PD} \cdot V_{CC}^2 \cdot f_{in} + I_{CC} \cdot V_{CC}$.

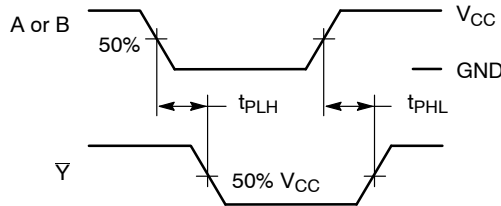
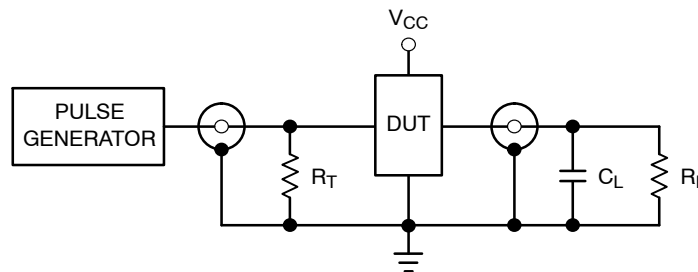

Figure 3. Switching Waveforms



$R_T = Z_{OUT}$ of pulse generator (typically 50 Ω)

Figure 4. Test Circuit

NLX3G17

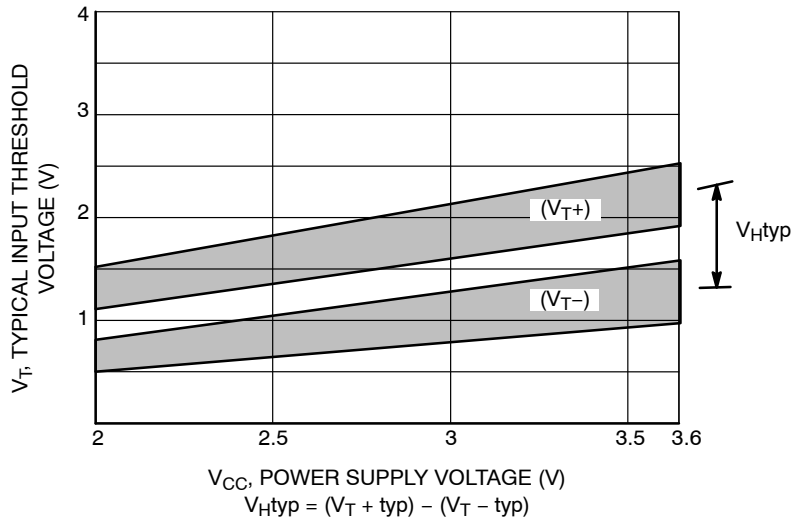
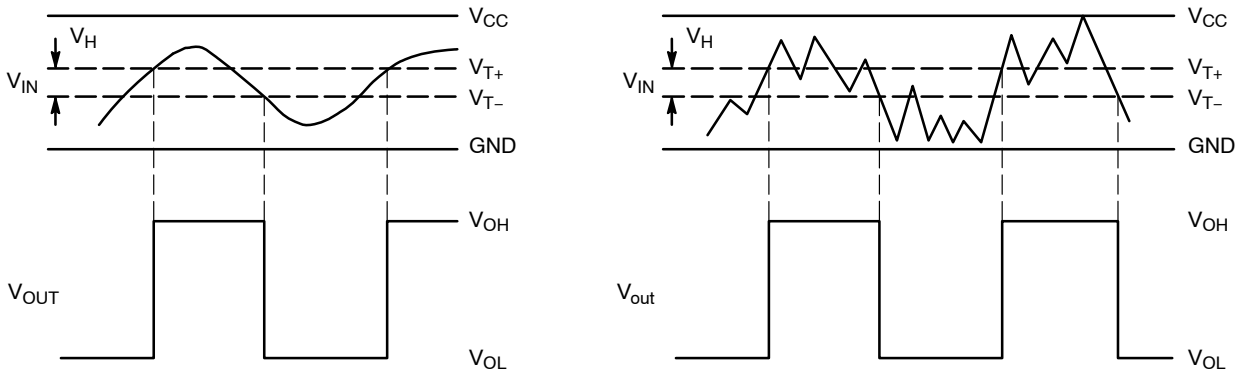

Figure 5. Typical Input Threshold, V_{T+} , V_{T-} versus Power Supply Voltage



(a) A Schmitt-Trigger Squares Up Inputs With Slow Rise and Fall Times

(b) A Schmitt-Trigger Offers Maximum Noise Immunity

Figure 6. Typical Schmitt-Trigger Applications

ORDERING INFORMATION

Device	Package	Shipping [†]
NLX3G17AMX1TCG	ULLGA8, 1.95 x 1.0, 0.5P (Pb-Free)	3000 / Tape & Reel
NLX3G17BMX1TCG	ULLGA8, 1.6 x 1.0, 0.4P (Pb-Free)	3000 / Tape & Reel
NLX3G17CMX1TCG	ULLGA8, 1.45 x 1.0, 0.35P (Pb-Free)	3000 / Tape & Reel
NLX3G17DMUTCG	UDFN8, 1.95 x 1.0, 0.5P (Pb-Free)	3000 / Tape & Reel
NLX3G17EMUTCG	UDFN8, 1.6 x 1.0, 0.4P (Pb-Free)	3000 / Tape & Reel
NLX3G17FMUTCG	UDFN8, 1.45 x 1.0, 0.35P (Pb-Free)	3000 / Tape & Reel

[†]For information on tape and reel specifications, including part orientation and tape sizes, please refer to our Tape and Reel Packaging Specifications Brochure, BRD8011/D.

NLX3G17

PACKAGE DIMENSIONS

UDFN8 1.6x1.0, 0.4P
CASE 517BY
ISSUE O

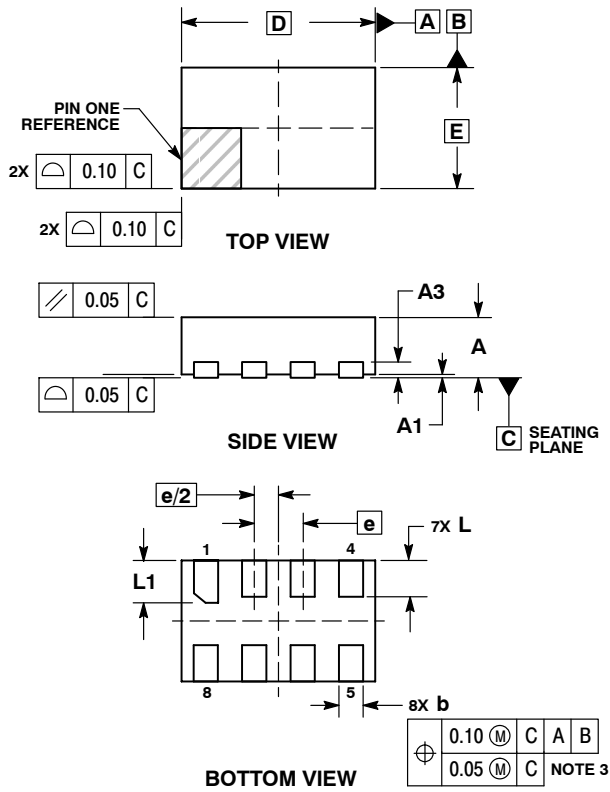

- NOTES:
1. DIMENSIONING AND TOLERANCING PER ASME Y14.5M, 1994.
 2. CONTROLLING DIMENSION: MILLIMETERS.
 3. DIMENSION b APPLIES TO PLATED TERMINAL AND IS MEASURED BETWEEN 0.15 AND 0.20 MM FROM TERMINAL TIP.
 4. PACKAGE DIMENSIONS EXCLUSIVE OF BURRS AND MOLD FLASH.

DIM	MILLIMETERS	
	MIN	MAX
A	0.45	0.55
A1	0.00	0.05
A3	0.13	REF
b	0.15	0.25
D	1.60	BSC
E	1.00	BSC
e	0.40	BSC
L	0.25	0.35
L1	0.30	0.40

RECOMMENDED SOLDERING FOOTPRINT*

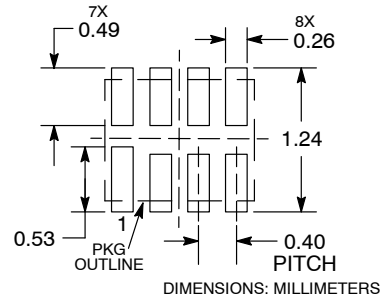

*For additional information on our Pb-Free strategy and soldering details, please download the ON Semiconductor Soldering and Mounting Techniques Reference Manual, SOLDERRM/D.

NLX3G17

PACKAGE DIMENSIONS

UDFN8 1.45x1.0, 0.35P
CASE 517BZ
ISSUE O

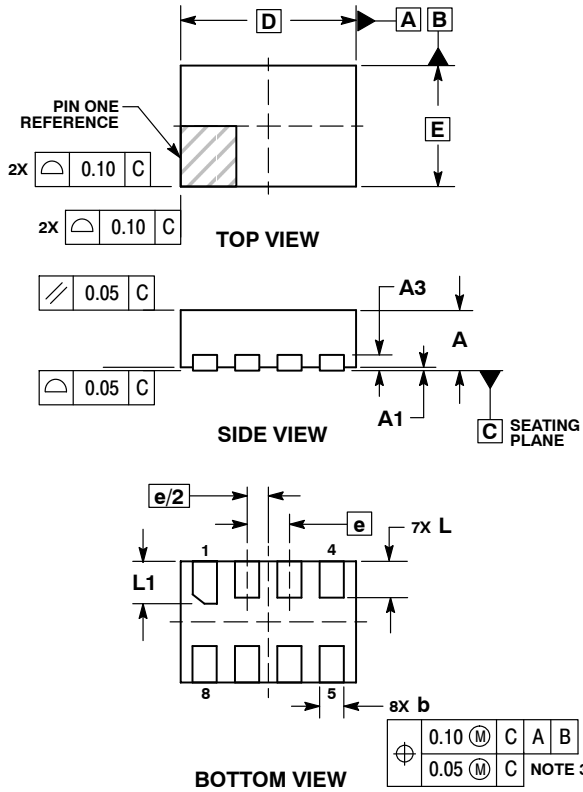

- NOTES:
1. DIMENSIONING AND TOLERANCING PER ASME Y14.5M, 1994.
 2. CONTROLLING DIMENSION: MILLIMETERS.
 3. DIMENSION b APPLIES TO PLATED TERMINAL AND IS MEASURED BETWEEN 0.15 AND 0.20 MM FROM TERMINAL TIP.
 4. PACKAGE DIMENSIONS EXCLUSIVE OF BURRS AND MOLD FLASH.

DIM	MILLIMETERS	
	MIN	MAX
A	0.45	0.55
A1	0.00	0.05
A3	0.13 REF	
b	0.15	0.25
D	1.45 BSC	
E	1.00 BSC	
e	0.35 BSC	
L	0.25	0.35
L1	0.30	0.40

RECOMMENDED SOLDERING FOOTPRINT*

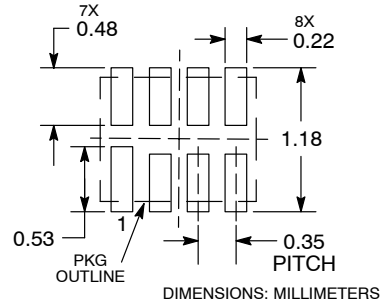

*For additional information on our Pb-Free strategy and soldering details, please download the ON Semiconductor Soldering and Mounting Techniques Reference Manual, SOLDERRM/D.

NLX3G17

PACKAGE DIMENSIONS

UDFN8 1.95x1.0, 0.5P
CASE 517CA
ISSUE O

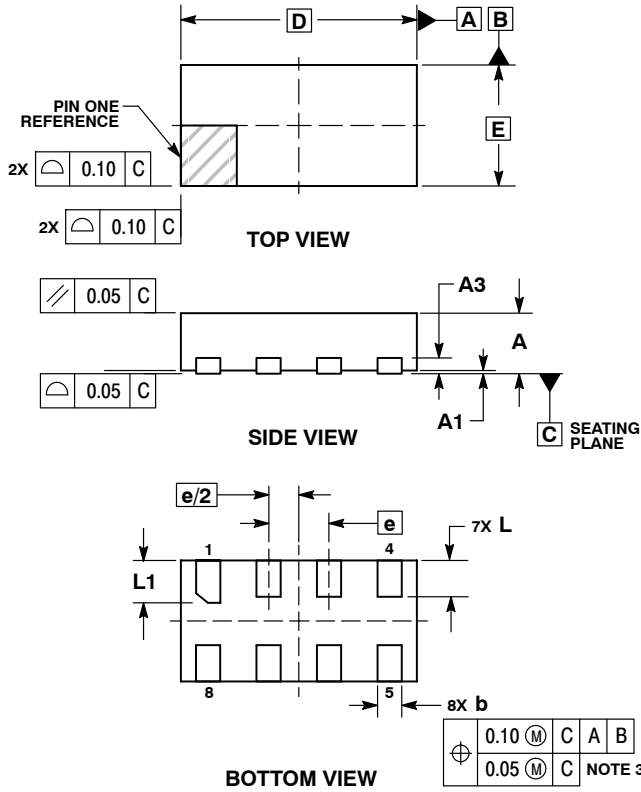

- NOTES:
1. DIMENSIONING AND TOLERANCING PER ASME Y14.5M, 1994.
 2. CONTROLLING DIMENSION: MILLIMETERS.
 3. DIMENSION b APPLIES TO PLATED TERMINAL AND IS MEASURED BETWEEN 0.15 AND 0.20 MM FROM TERMINAL TIP.
 4. PACKAGE DIMENSIONS EXCLUSIVE OF BURRS AND MOLD FLASH.

MILLIMETERS		
DIM	MIN	MAX
A	0.45	0.55
A1	0.00	0.05
A3	0.13 REF	
b	0.15	0.25
D	1.95 BSC	
E	1.00 BSC	
e	0.50 BSC	
L	0.25	0.35
L1	0.30	0.40

RECOMMENDED SOLDERING FOOTPRINT*

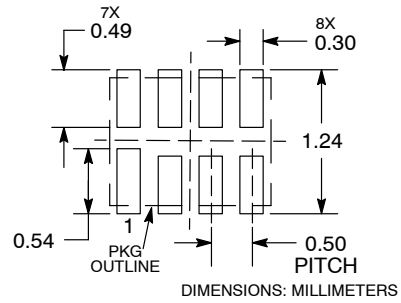

*For additional information on our Pb-Free strategy and soldering details, please download the ON Semiconductor Soldering and Mounting Techniques Reference Manual, SOLDERRM/D.

NLX3G17

PACKAGE DIMENSIONS

ULLGA8 1.45x1.0, 0.35P
CASE 613AA
ISSUE A

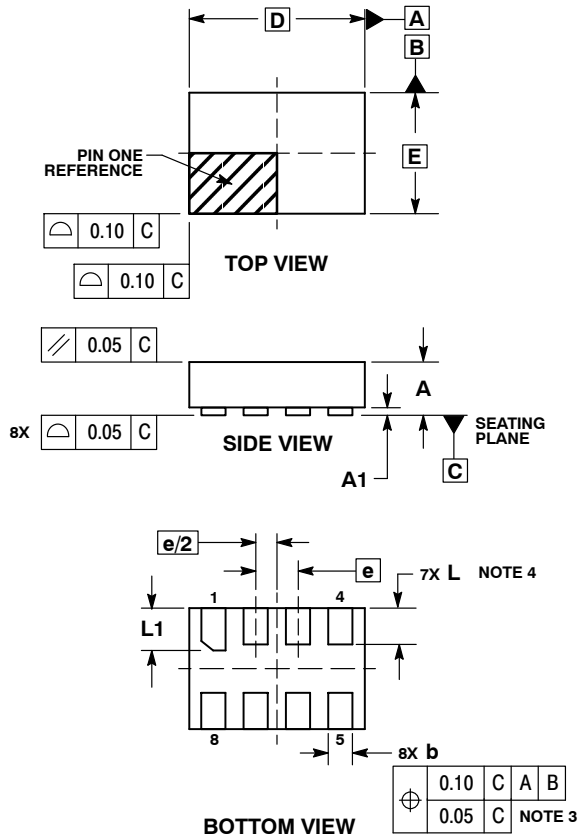

NOTES:

1. DIMENSIONING AND TOLERANCING PER ASME Y14.5M, 1994.
2. CONTROLLING DIMENSION: MILLIMETERS.
3. DIMENSION b APPLIES TO PLATED TERMINAL AND IS MEASURED BETWEEN 0.15 AND 0.30 mm FROM THE TERMINAL TIP.
4. A MAXIMUM OF 0.05 PULL BACK OF THE PLATED TERMINAL FROM THE EDGE OF THE PACKAGE IS ALLOWED.

DIM	MILLIMETERS	
	MIN	MAX
A	---	0.40
A1	0.00	0.05
b	0.15	0.25
D	1.45 BSC	
E	1.00 BSC	
e	0.35 BSC	
L	0.25	0.35
L1	0.30	0.40

**MOUNTING FOOTPRINT
SOLDERMASK DEFINED***

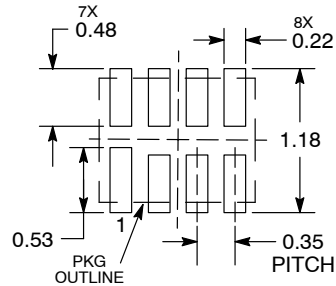

DIMENSIONS: MILLIMETERS

*For additional information on our Pb-Free strategy and soldering details, please download the ON Semiconductor Soldering and Mounting Techniques Reference Manual, SOLDERRM/D.

NLX3G17

PACKAGE DIMENSIONS

ULLGA8 1.6x1.0, 0.4P
CASE 613AB
ISSUE A

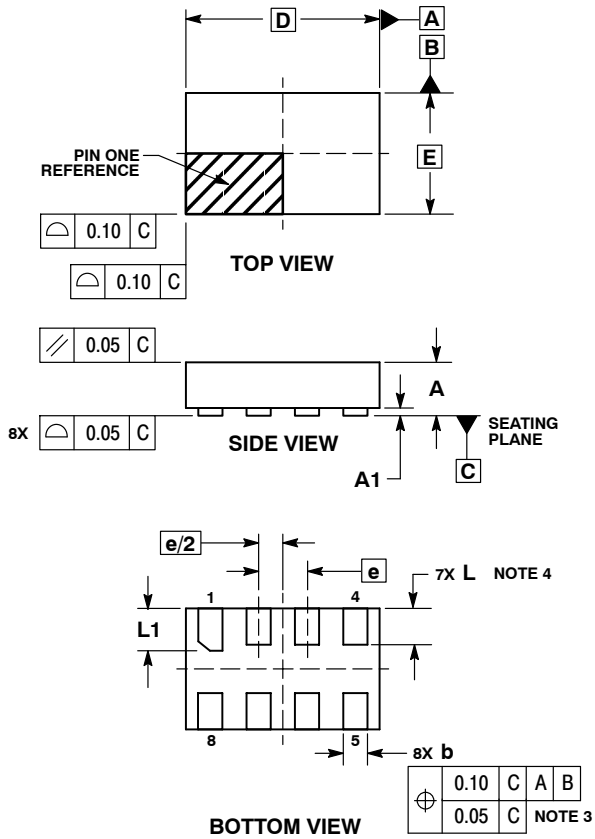

NOTES:

1. DIMENSIONING AND TOLERANCING PER ASME Y14.5M, 1994.
2. CONTROLLING DIMENSION: MILLIMETERS.
3. DIMENSION b APPLIES TO PLATED TERMINAL AND IS MEASURED BETWEEN 0.15 AND 0.30 mm FROM THE TERMINAL TIP.
4. A MAXIMUM OF 0.05 PULL BACK OF THE PLATED TERMINAL FROM THE EDGE OF THE PACKAGE IS ALLOWED.

MILLIMETERS		
DIM	MIN	MAX
A	---	0.40
A1	0.00	0.05
b	0.15	0.25
D	1.60 BSC	
E	1.00 BSC	
e	0.40 BSC	
L	0.25	0.35
L1	0.30	0.40

**MOUNTING FOOTPRINT
SOLDERMASK DEFINED***

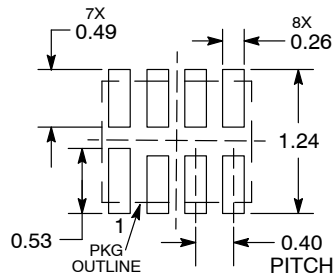

DIMENSIONS: MILLIMETERS

*For additional information on our Pb-Free strategy and soldering details, please download the ON Semiconductor Soldering and Mounting Techniques Reference Manual, SOLDERRM/D.

