

ITEM NO.	CRIMP SIZE	MATERIAL	PLATING	PACKAGING	'D'
42824-4001	18 AWG	.0160±.0005/(0.406/0.013) THICK BRASS ALLOY *C23000	PRE-TINNED .000202/ (0.0005) MIN. TIN	SUPPLIED ON REEL	.225 (5.72)
42824-4002	12 AWG			SUPPLIED LOOSE	
42824-4003	12 AWG			SUPPLIED ON REEL	.238 (6.05)
42824-4004	18 AWG			SUPPLIED LOOSE	
42824-4005	12 AWG				
42824-4006	12 AWG				

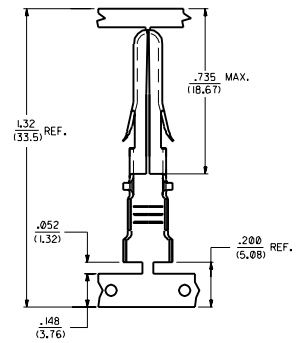

STRIP AND CARRIER LAYOUT
SCALE 4:1

- NOTES:
1. THIS TERMINAL FOR USE IN HOUSING NO'S. 40585-1-5, 40585-3000, 43032-3300, 43032-3400, AND 43032-3500.
 2. TERMINALS FOR USE WITH SOLID OR STRANDED WIRE.
 3. TERMINALS TO BE SUPPLIED IN CHAIN FORM.
 4. PRODUCT CONFORMS TO PS-40585.
 5. REELS OF THESE TERMINALS CANNOT HAVE MECHANICAL SPLICES.
 6. USING SEAM LINE AS VERTICAL CENTERLINE INDICATOR- MAXIMUM EXCURSION FROM HORIZONTAL CENTERLINE IS INDICATED FOR BOTH LOCK AND STOP TABS.

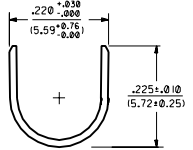
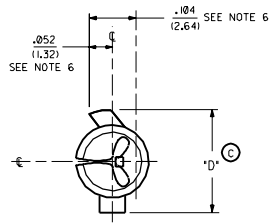
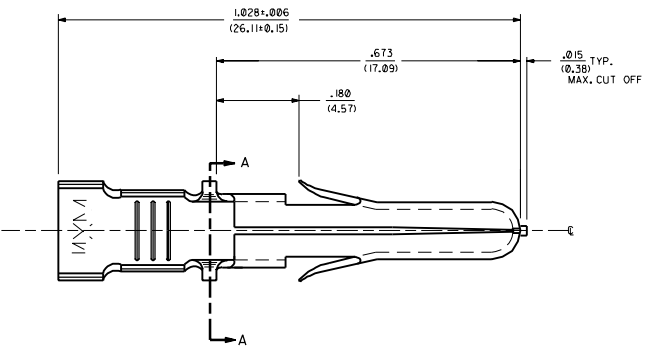

INSULATION CRIMP DETAIL

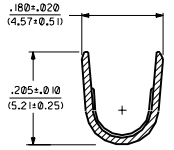

SECTION B-B

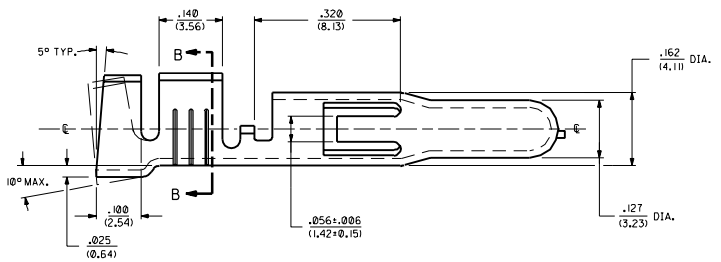

12 AWG TERMINAL SHOWN

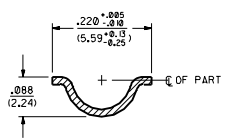

SECTION A-A

C	ADD P/MS - 04 TH - 06 ECH USE 2000-0116 NUMBER 00-02-22
B1	REV'D TAB & DIMS. ECH 06/14/91 MW 98-03-21
B	UPDATE PICTORIAL ECH 08/08/91 C.E.S. 99-05-0
A4	ADD .4003 ECH 07/08/91 C.E.S. 99-05-0
A3	ADD 249 DIM ECH 03/02/90 DMS
A2	UPDATE TO I.R. ECH 06/24/89 DMS
A1	UPDATE TO I.R. ECH 04/26/89 DMS
2	REMOVE X ECH 02/13/87
1	92/09/80 DMS

MOLEX INCORPORATED

REVISIONS

REV. LTR. REVISIONS

2 01

1 C

DATE: 03/03/98

FILE: PIN TERMINAL .125 (3,18) DIA.

1 OF 2

SEE CHART SD-42824-40

SCALE: 1:1

FOR ASSEMBLY CONSULT MANUFACTURER'S SPECIFICATIONS FOR MATERIALS AND FINISHES.

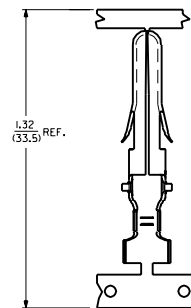
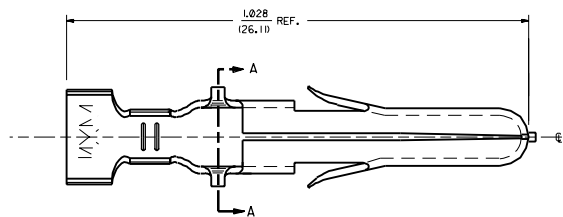

STRIP AND CARRIER LAYOUT
SCALE 4:1

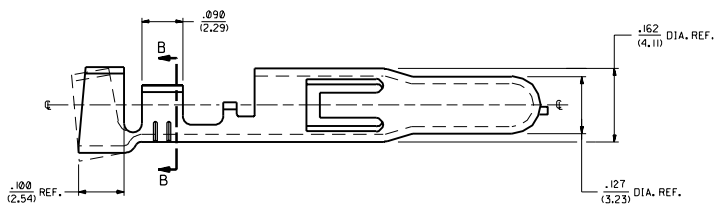

18 AWG TERMINAL SHOWN

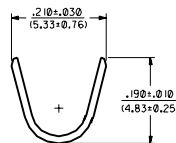

INSULATION CRIMP DETAIL

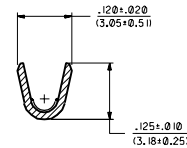

SECTION B-B

B1	SEE SHEET 1
B	SEE SHEET 1
A4	SEE SHEET 1
A3	SEE SHEET 1
A2	SEE SHEET 1
A1	SEE SHEET 1
A	SEE SHEET 1

DIMENSIONS SHOWN HEREIN IN: INCH <input type="checkbox"/> MILLIMETER <input checked="" type="checkbox"/>		REVISIONS:	
TITLE: PIN TERMINAL .125 (3.18) DIA.		REV. 1 DATE: 12/20/23	
MFG. CODE: SD-42824-40		PART NO.: SD-42824-40	
DRAWN BY: TRM		CHECKED BY: SBB	
SCALE: 8:1		DATE: 12/20/23	
MOLEX INCORPORATED		MOLEX INCORPORATED	
SEE CHART SD-42824-40		MOLEX INCORPORATED	