

## DETAILS

<b>Product Number</b>	CA13627_G2-LAURA-M-P
<b>Family</b>	Laura
<b>Type</b>	Assembly
<b>Color</b>	white
<b>Diameter</b>	21,6 x 21,6 mm
<b>Height</b>	13,1 mm
<b>Style</b>	square
<b>Optic Material</b>	PMMA
<b>Holder Material</b>	
<b>Fastening</b>	pin, tape
<b>Status</b>	production ready
<b>ROHS Compliant</b>	Yes
<b>Date Updated</b>	21/04/2016

## OPTICAL PROPERTIES

LED	Viewing	Light	Effi-	cd/lm	Connector
	Angle	Beam	ciency		
XP-E	30 deg	Medium	92 %	2.600	-
XP-E2	31 deg	Medium	85 %	2.500	-
XP-G	33 deg	Medium	83 %	2.300	-
XP-G2	33 deg	Medium	85 %	2.400	-
XT-E	31 deg	Medium	85 %	2.500	-
XB-H	33 deg	Medium	85 %	2.300	-
LUXEON TX	30 deg	Medium	86 %	2.500	-
LUXEON 3030 2D	25 deg	Medium	85 %	3.200	-
NCSxx19A	29 deg	Medium	86 %	2.700	-
NVSxx19A	30 deg	Medium	85 %	2.500	-
NVSxx19B/NVSxx19C	28 deg	Medium	84 %	2.800	-
Oslon Square EC	32 deg	Medium	85 %	2.400	-
Oslon Square PC	31 deg	Medium	84 %	2.400	-
SFH 4770S	sim: 27	Medium	sim: 88 %	-	-
Oslon Black Flat	sim: 21	Medium	sim: 94 %	sim: 5.400	-
Oslon Black	sim: 22	Medium	sim: 97 %	sim: 5.300	-
Z5M1/Z5M2	30 deg	Medium	84 %	2.430	-
Z8Y22P	sim: 29	Medium	sim: 96 %	sim: 3.420	-



Relative intensity of CA13627\_G2-LAURA-M-P\_(NVSxx19B)

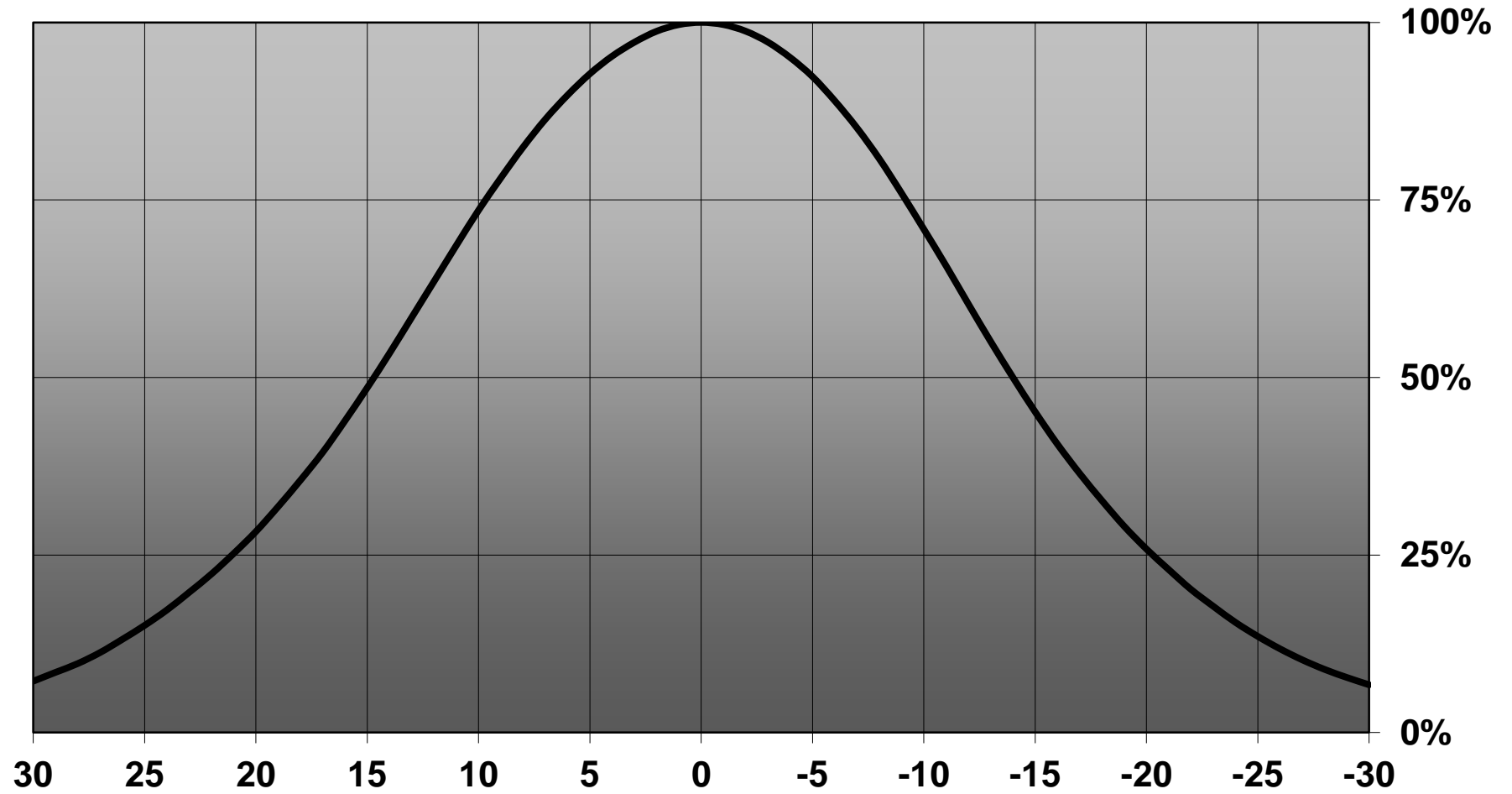

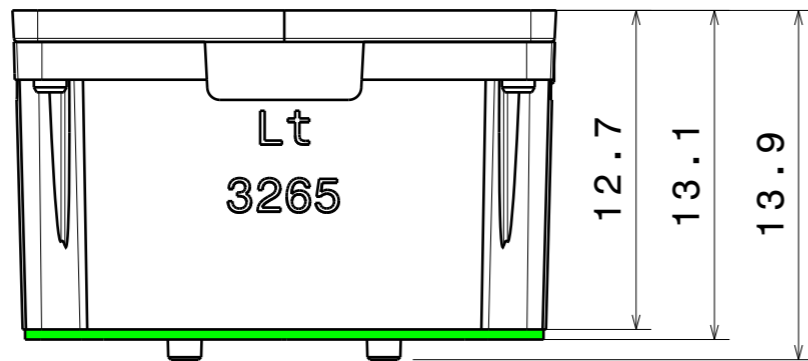
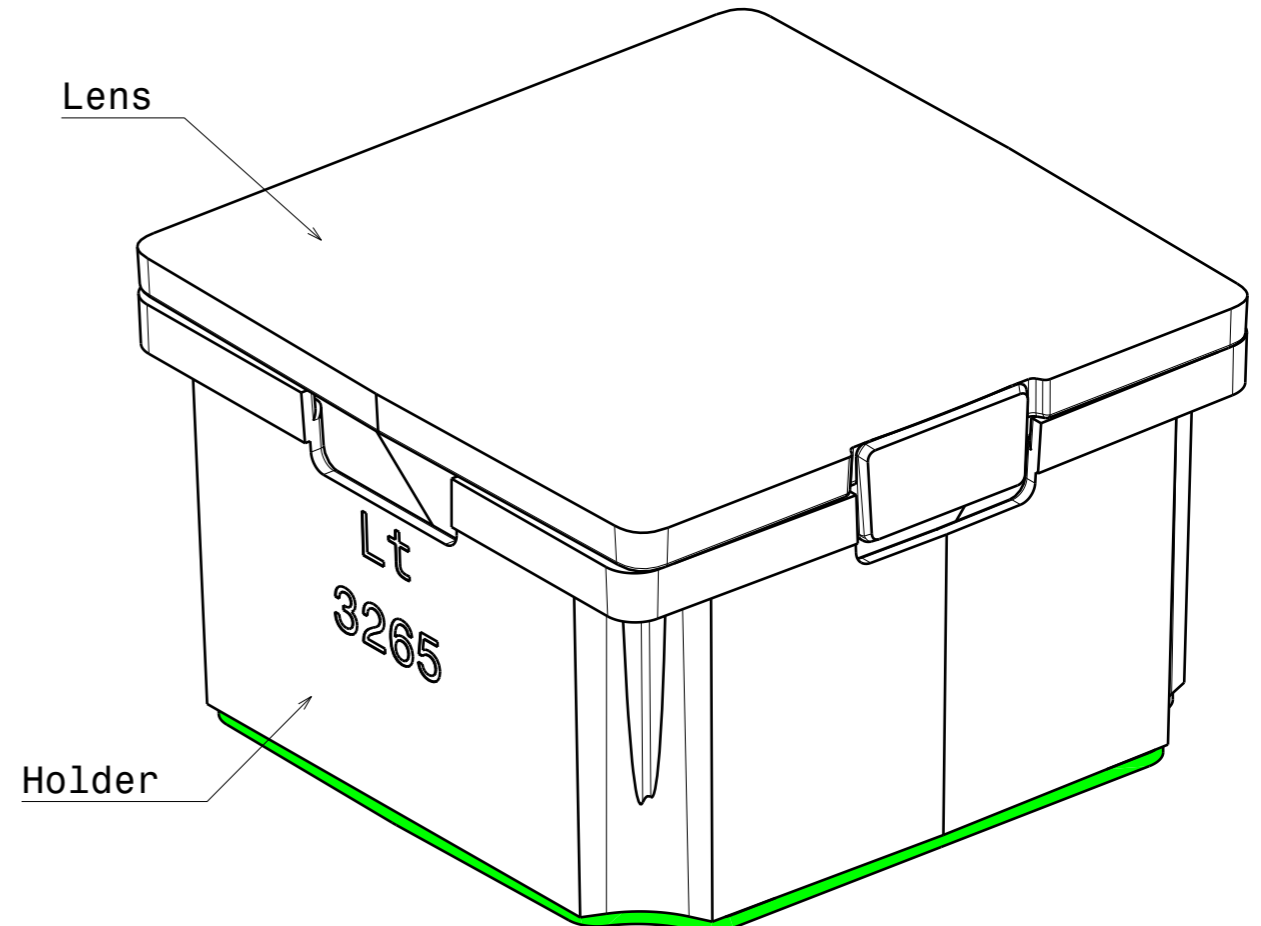
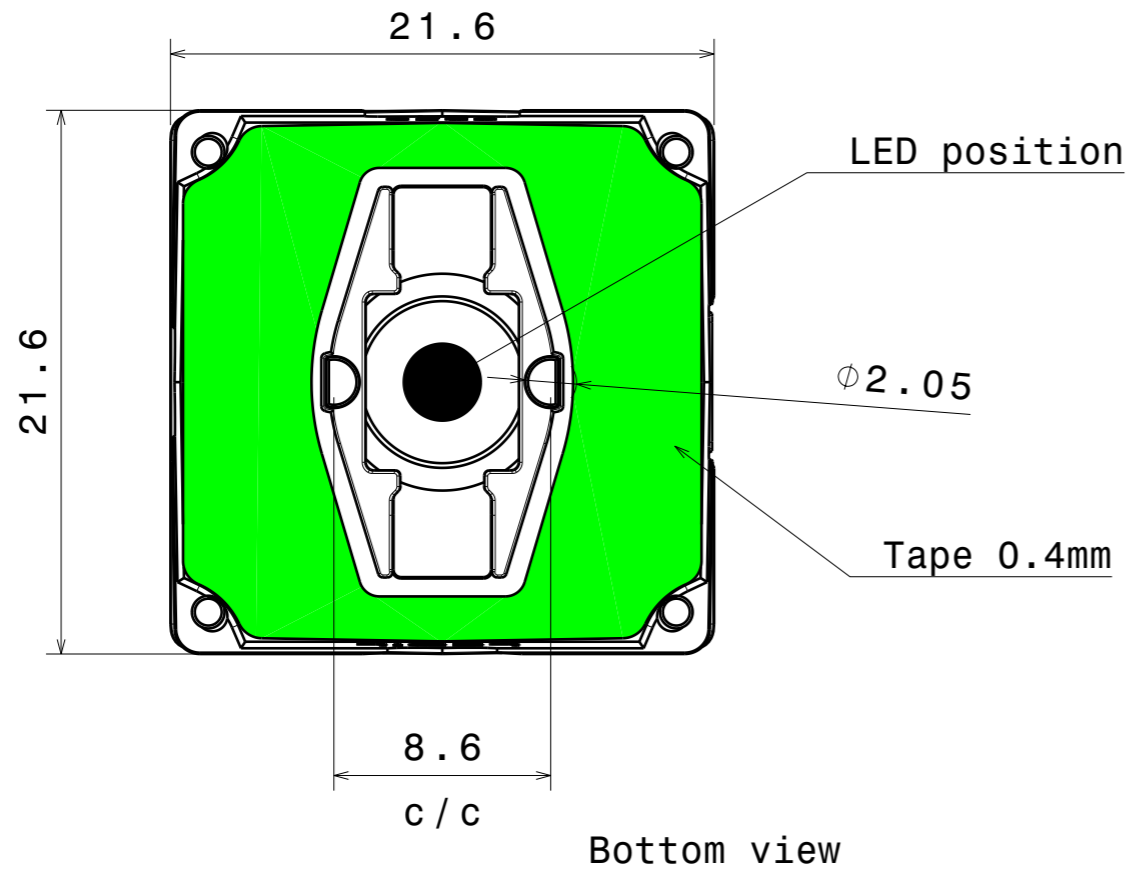

INDEX	PART NO	MATERIAL	COLOUR
1	-	PU foam	black
2	C13265	PC	white
3	C12550	PMMA	clear

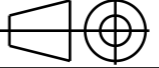
Tolerances if not otherwise shown According to DIN ISO 2768-1 Linear measures: class M According to DIN ISO 2768-2 Form and position: class L		 Ledil Oy Salorankatu 10 FIN 24240 SALO Finland	
THIRD ANGLE PROJECTION: 		DRAWING TITLE <b>CA13627_G2-LAURA-M-P</b>	
This drawing is the property of LEDiL Oy. It may not be reproduced, copied or communicated without a written agreement with LEDiL Oy.		SIZE <b>A3</b>	PART NUMBER <b>CA13627</b>
SCALE 10:3		WEIGHT -	SHEET 1/1

Luminaire: LEDil Oy CA13627\_G2-LAURA-M-P\_(XP-E2)

Lamps: 1 x Cree XP-E2 (XPEBWT-L1-7B4-Q4-0-01) 79.02lm @ 250mA P=0.8W I=250mA

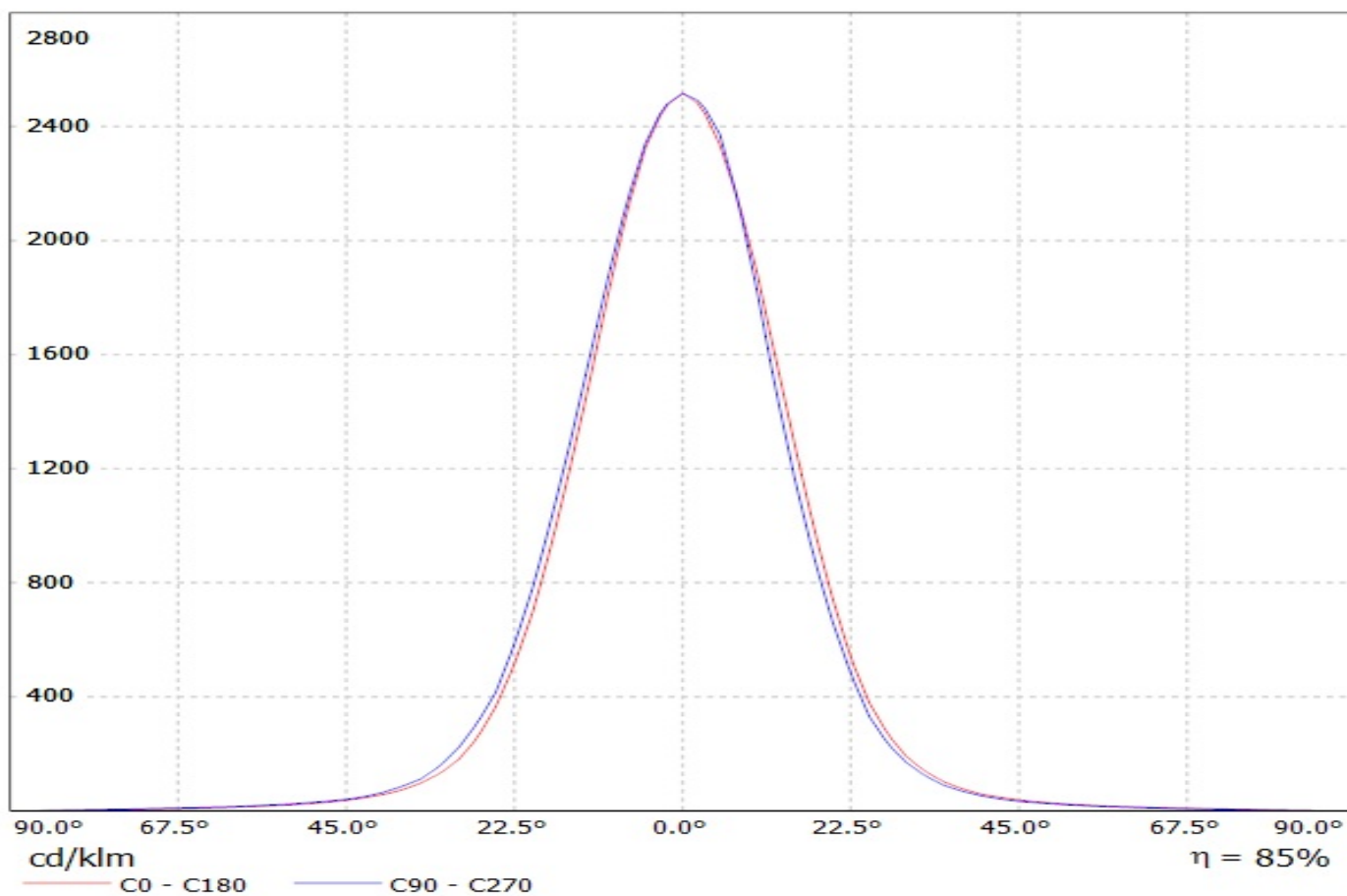

Luminaire: LEDil Oy CA13627\_G2-LAURA-M-P (XP-G)

Lamps: 1 x Cree XP-G (XPGWHT\_L1-CWPI-00BE7) 67lm @ 250mA CCT=3061K P=0.75W I=250mA

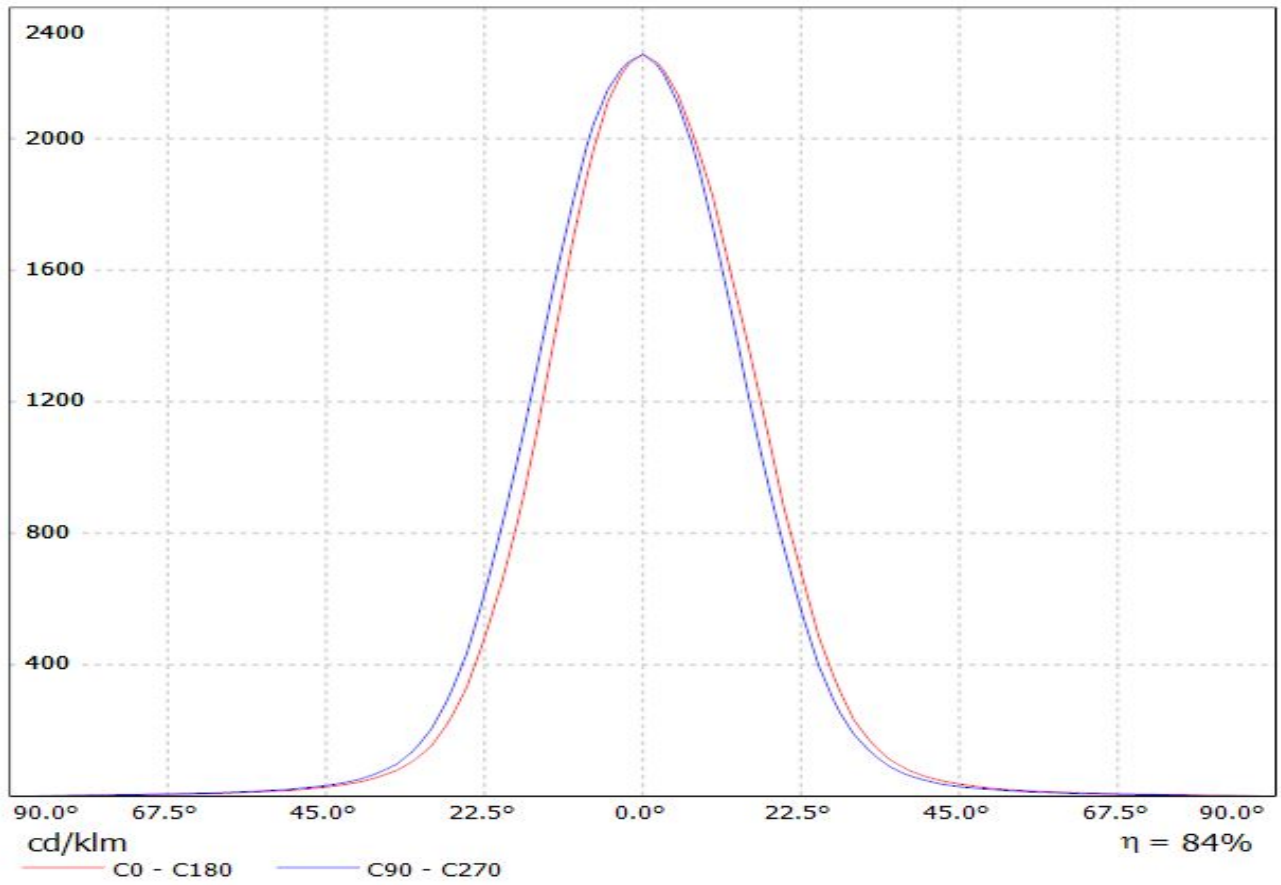

Luminaire: LEDil Oy CA13627\_G2-LAURA-M-P\_(XP-G2)

Lamps: 1 x Cree XP-G2 (XPGBWTL1-0000-00FE4) 100lm @ 250mA CCT=4934K P=0.74w I=250mA

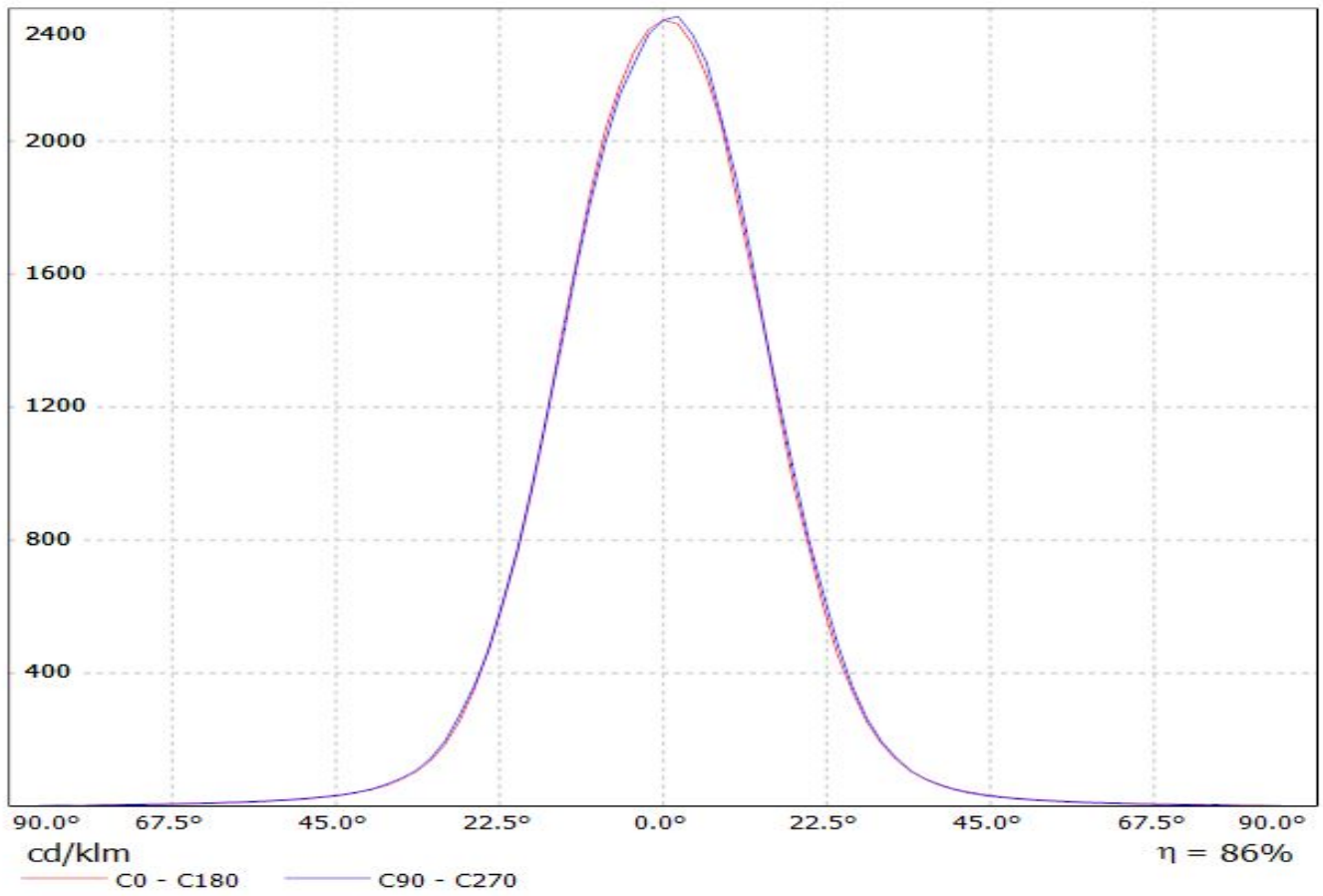

Luminaire: LEDil Oy CA13627\_G2-LAURA-M-P\_(XT-E)

Lamps: 1 x Cree XT-E (XTEAWT-00-0000-00000HBE8) 73.22lm @ 250mA CCT=2800K P=0.8W I=250mA

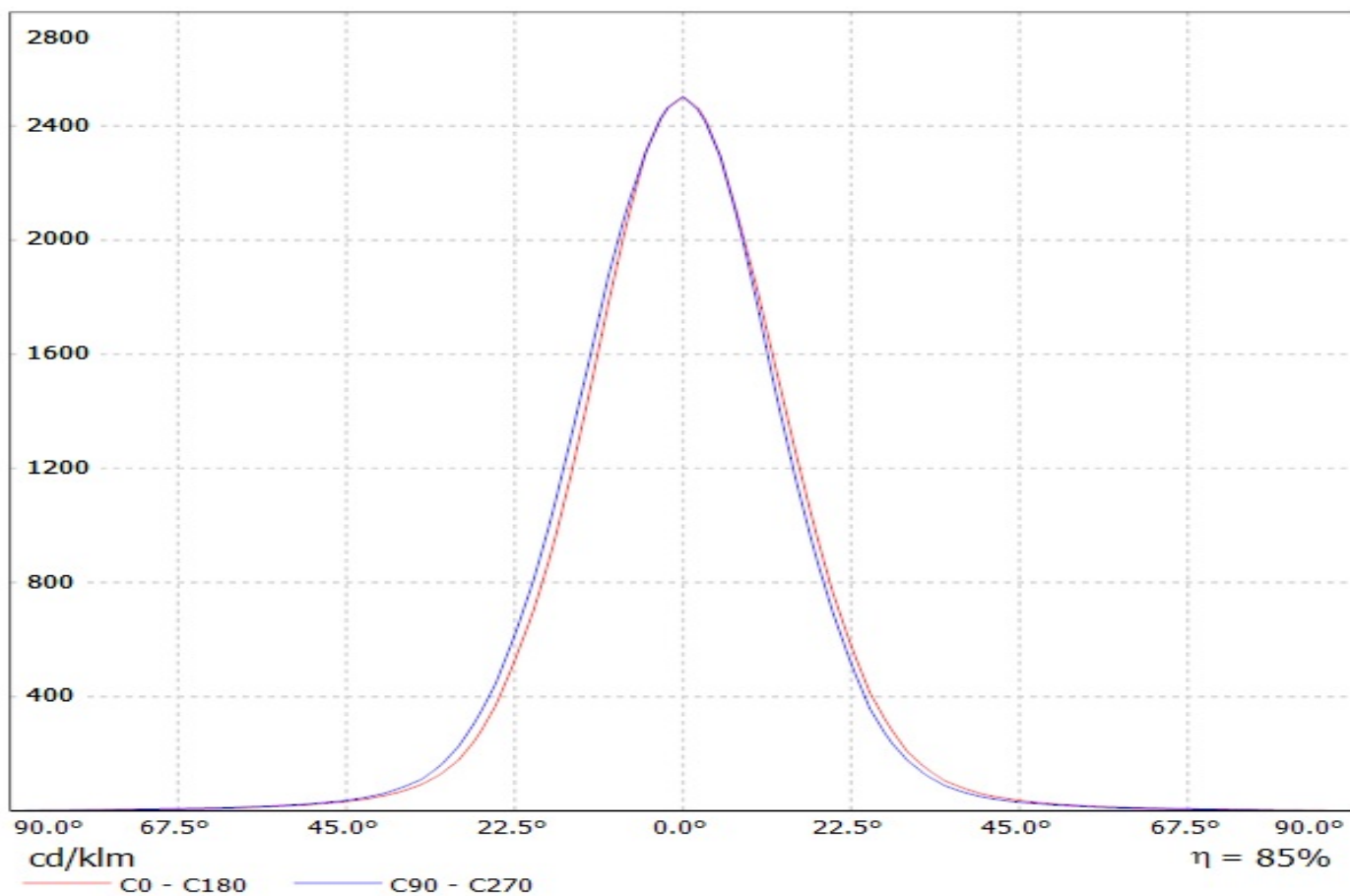

Luminaire: Ledil Oy CA13627\_G2-LAURA-M-P\_(XB-H)

Lamps: 1 x Cree XB-H (XBHAWT-0-3C0-T50-0B-0001) 106lm @ 250mA CCT= P=0.73W I=250mA

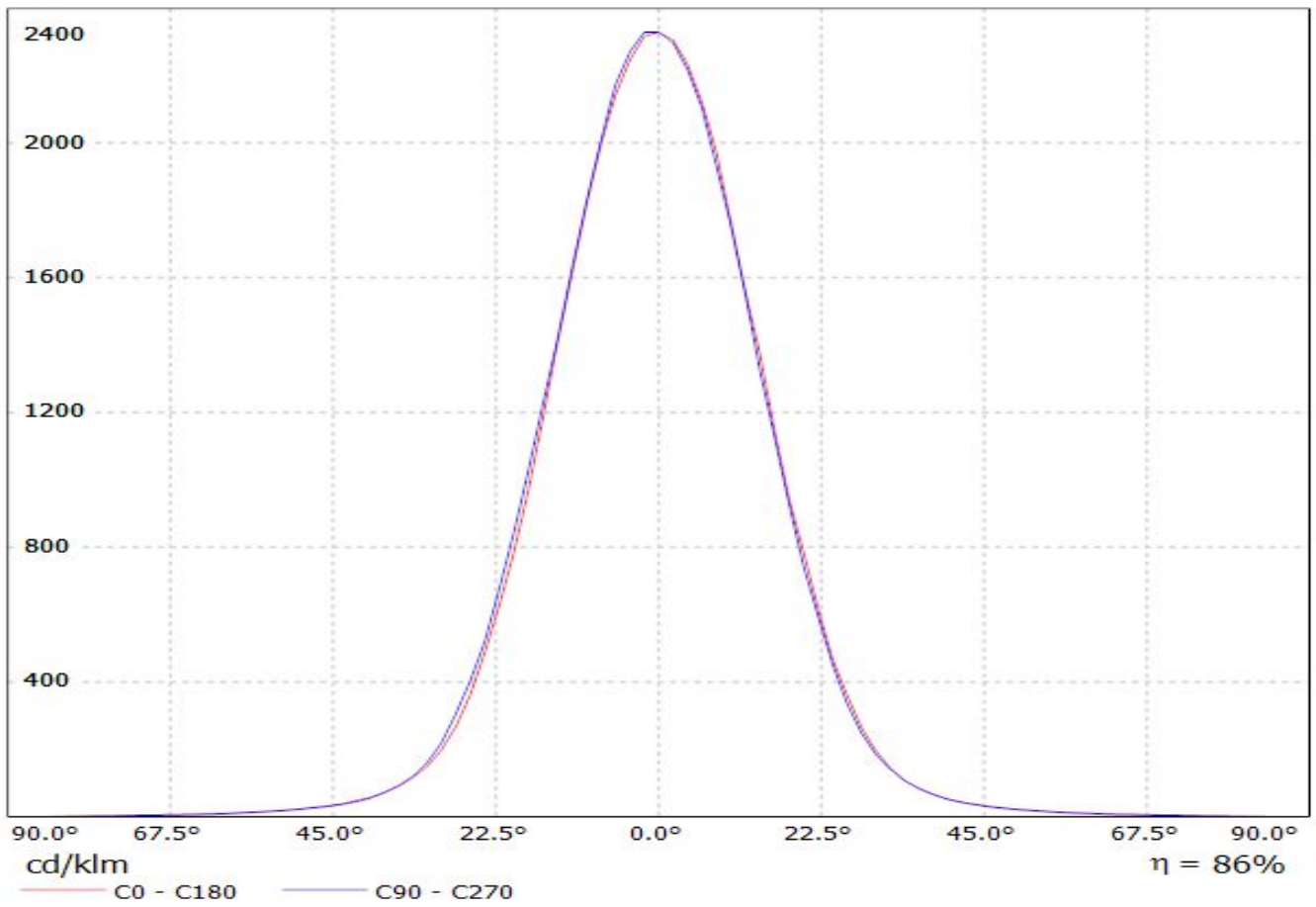



Luminaire: Ledil Oy CA13627\_G2-LAURA-M-P (Luxeon\_TX) Efficiency=86%  
Lamps: 1 x Luxeon TX (L1T2-3585) 108lm @ 250mA CCT=3521K P=0.73W I=250mA

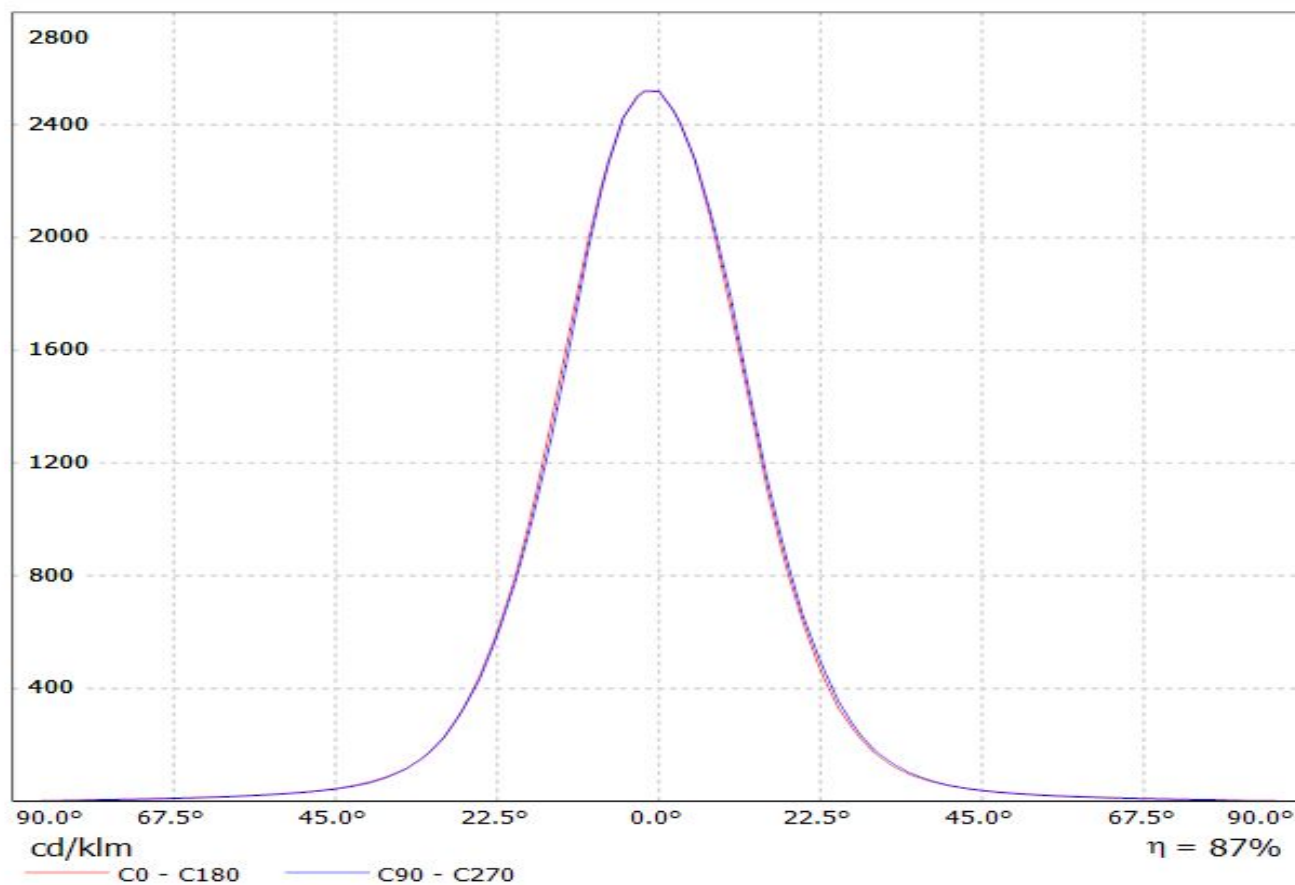

Luminaire: Ledil CA13627\_G2-LAURA-M-P (LUXEON\_3030\_2D)  
Lamps: 1 x LUXEON\_3030\_2D\_(L130-5080)\_73.2834lm@100mA\_CCT=5000K\_P=0.595784W\_I=0.1A

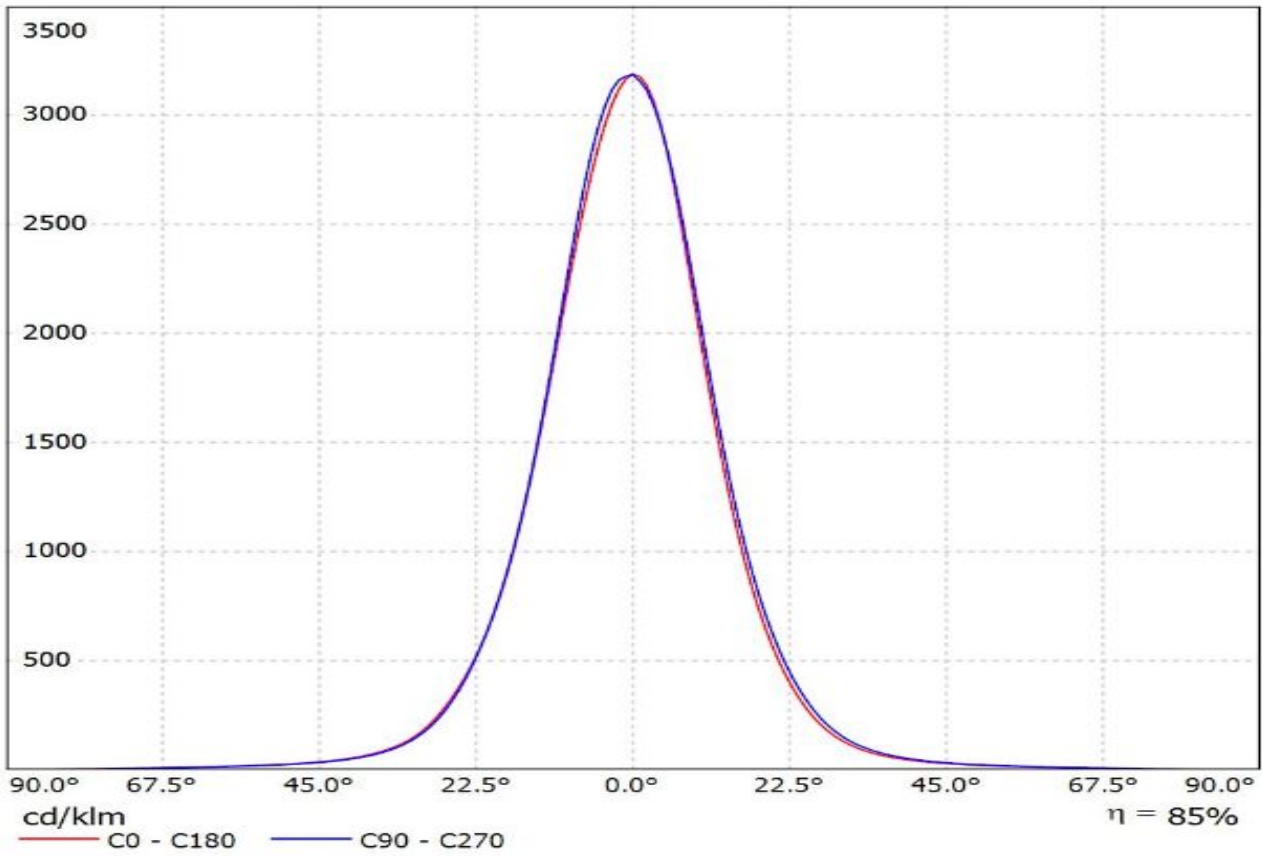

Luminaire: LEDiL CA13627\_G2-LAURA-M-P\_(NCS19)  
Lamps: 1 x Nichia NCSxx19A 65lm @ 250mA CCT= P=0.77W I=250mA

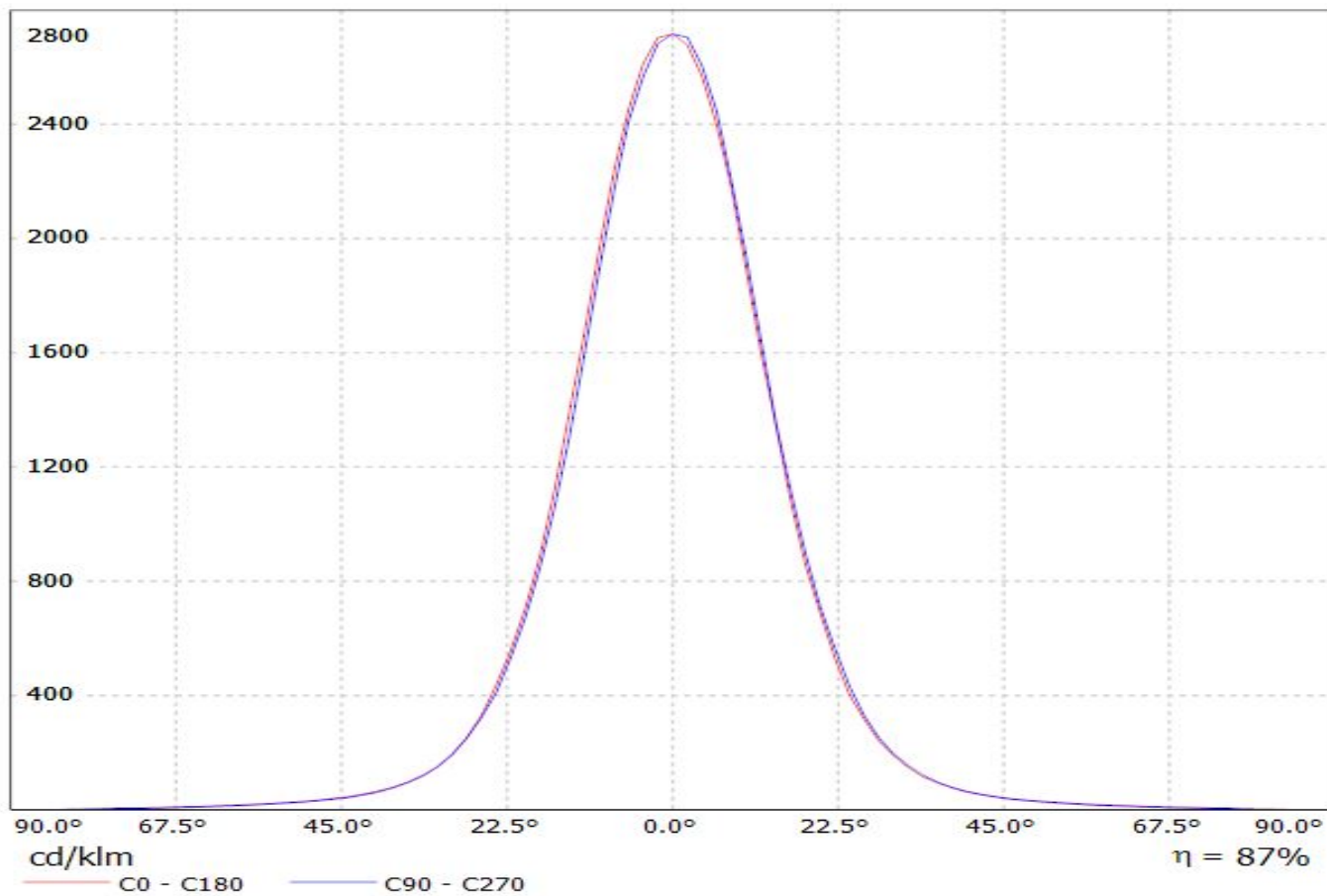

Luminaire: Ledil Oy CA13627\_G2-LAURA-M-P\_(NVS19)

Lamps: 1 x Nichia NVSxx19A 93lm @ 250mA CCT=5010K P=0.75W I=250mA

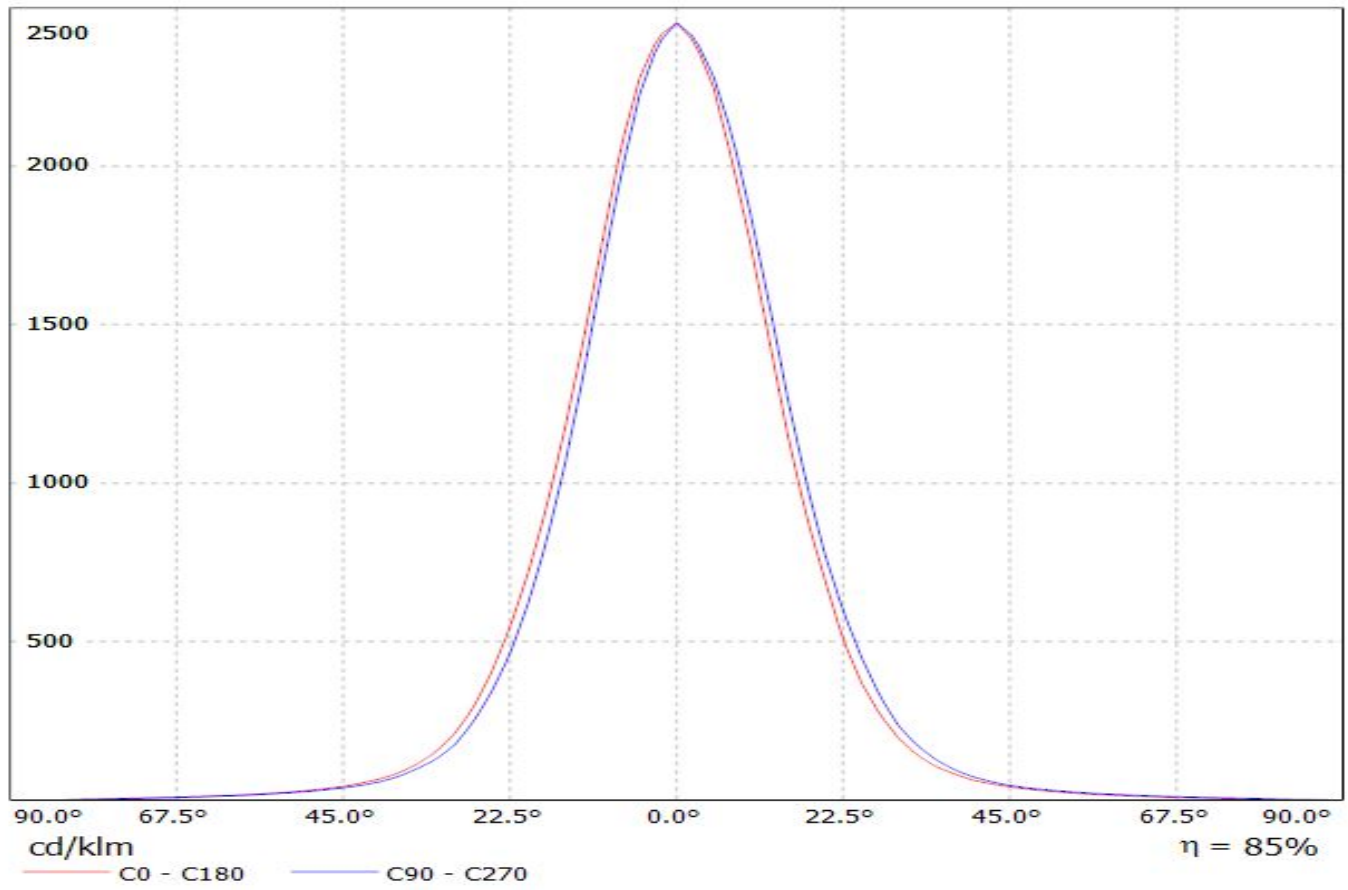

Luminaire: LEDil Oy CA13627\_G2-LAURA-M-P\_(Oslon\_Square\_EC)

Lamps: 1 x Osram Oslon Square EC (LCW CQAR-EC-MQMS-5R8T-35) 77.57lm @ 250mA CCT=3226K P=0.8W I=250mA

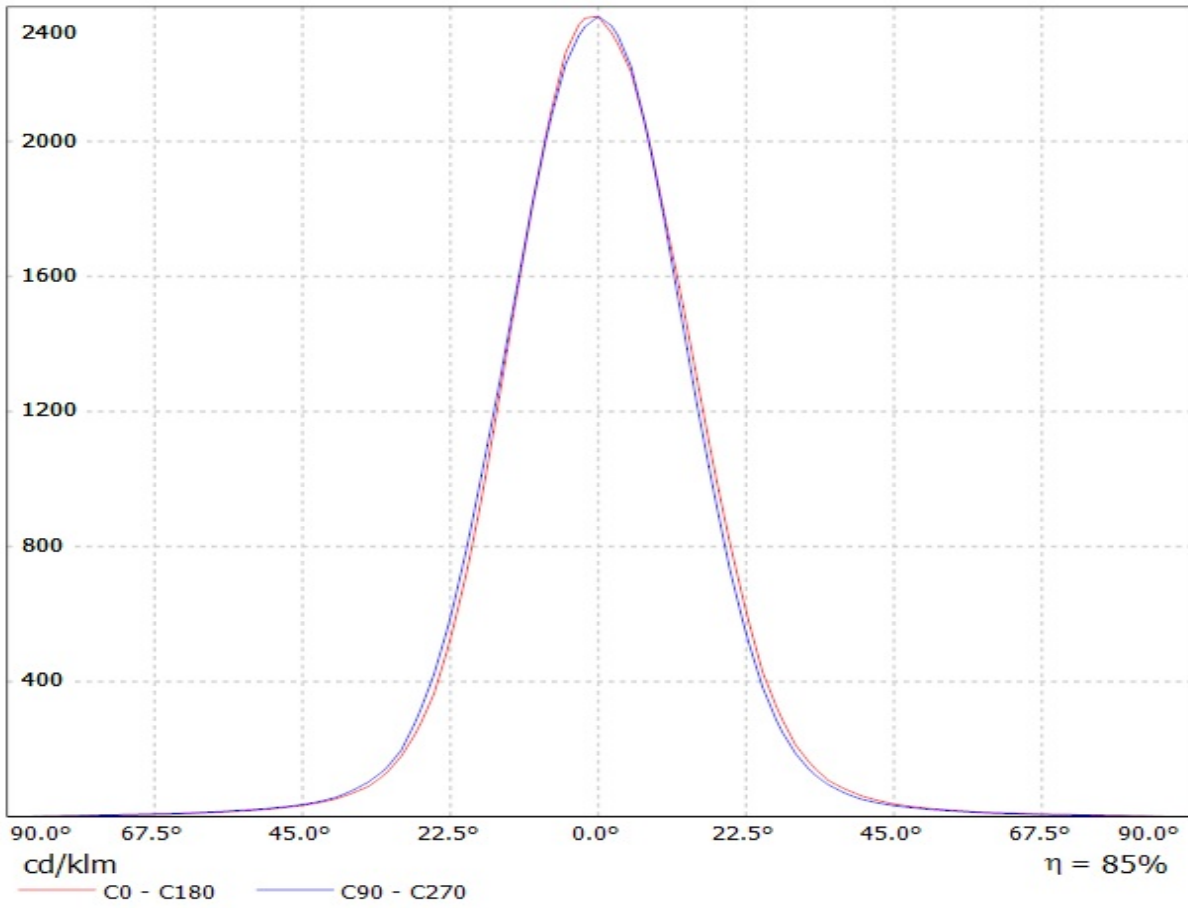

# Ledil CA13627\_G2-LAURA-M-P\_(SQ-PC) / LDC (Linear)

Luminaire: Ledil CA13627\_G2-LAURA-M-P\_(SQ-PC)  
Lamps: 1 x Osram\_Oslon\_Square-PC\_(LCW\_CQAR.PL-MSMV-SH71-1)  
\_103.48lm@250mA\_CCT=5913K\_P=0.8W\_I=0.25A

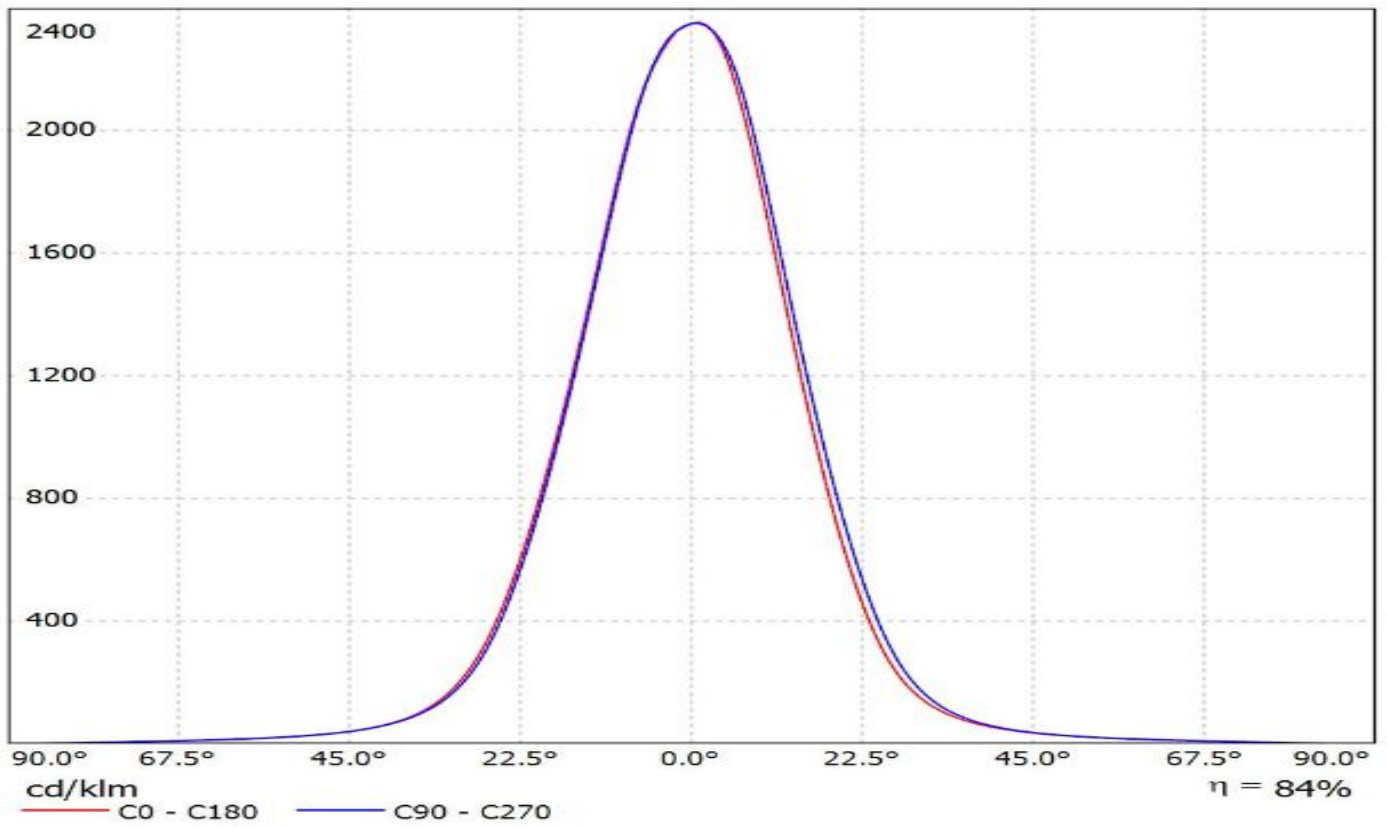

Luminaire: Ledil Oy CA13627\_G2-LAURA-M-P\_(Oslon\_Black\_Flat)\_SIMULATED  
Lamps: 1 x Osram Oslon Black Flat (LUW HWQP)

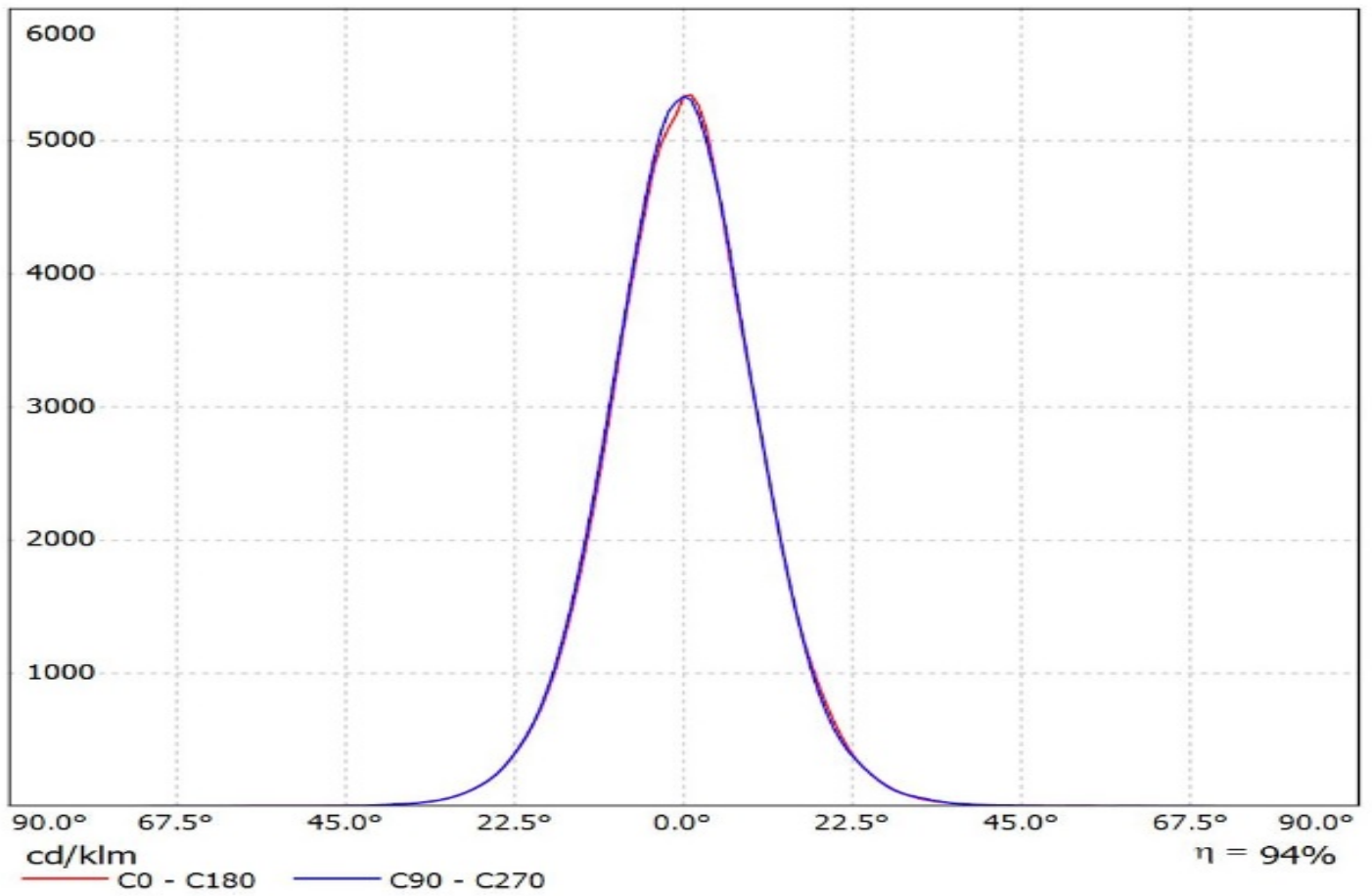

Luminaire: Ledil CA13627\_G2-LAURA-M-P\_(Z5M1)

Lamps: 1 x Seoul\_Z5M1\_(SZ5-M1-W0-C8)\_110.161lm@250mA\_P=0.7398W\_I=0.250A

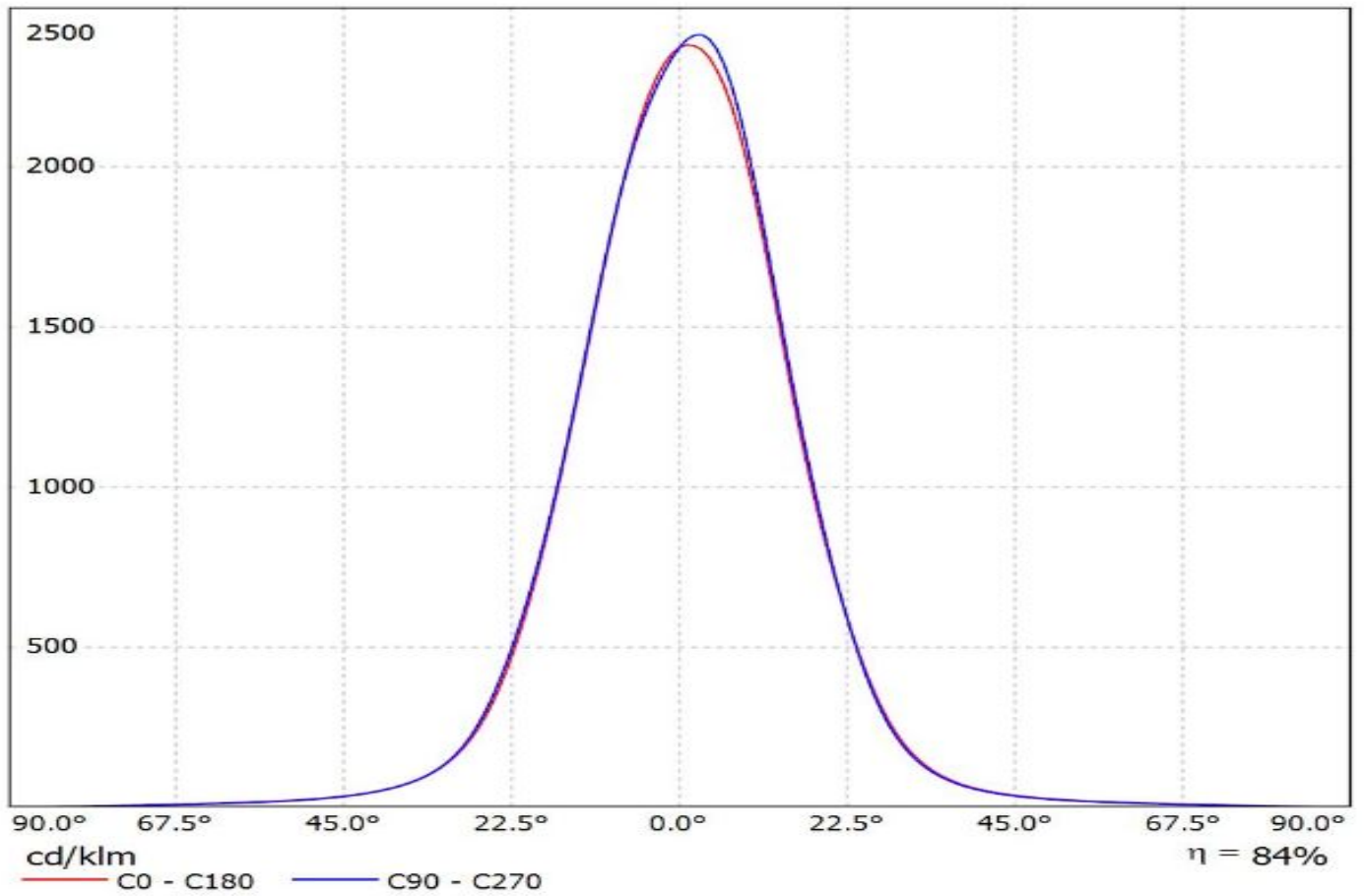



Luminaire: Ledil Oy CA13627\_G2-LAURA-M-P\_Seoul\_Z8Y22P\_SIMULATED  
Lamps: 1 x Seoul Z8Y22P

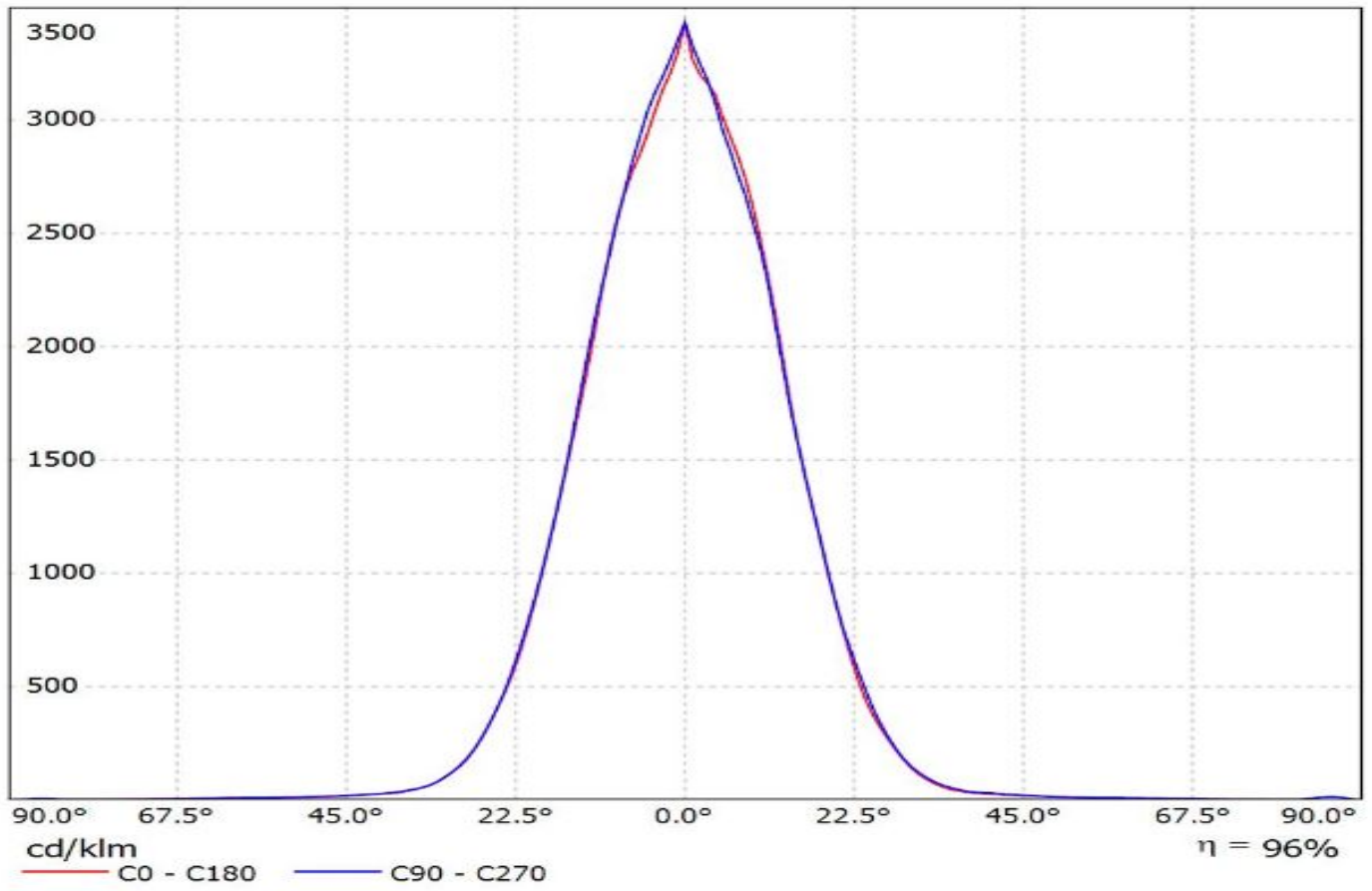

Luminaire: LEDil Oy CA13627\_G2-LAURA-M-P\_(XP-E2)

Lamps: 1 x Cree XP-E2 (XPEBWT-L1-7B4-Q4-0-01) 79.02lm @ 250mA P=0.8W I=250mA

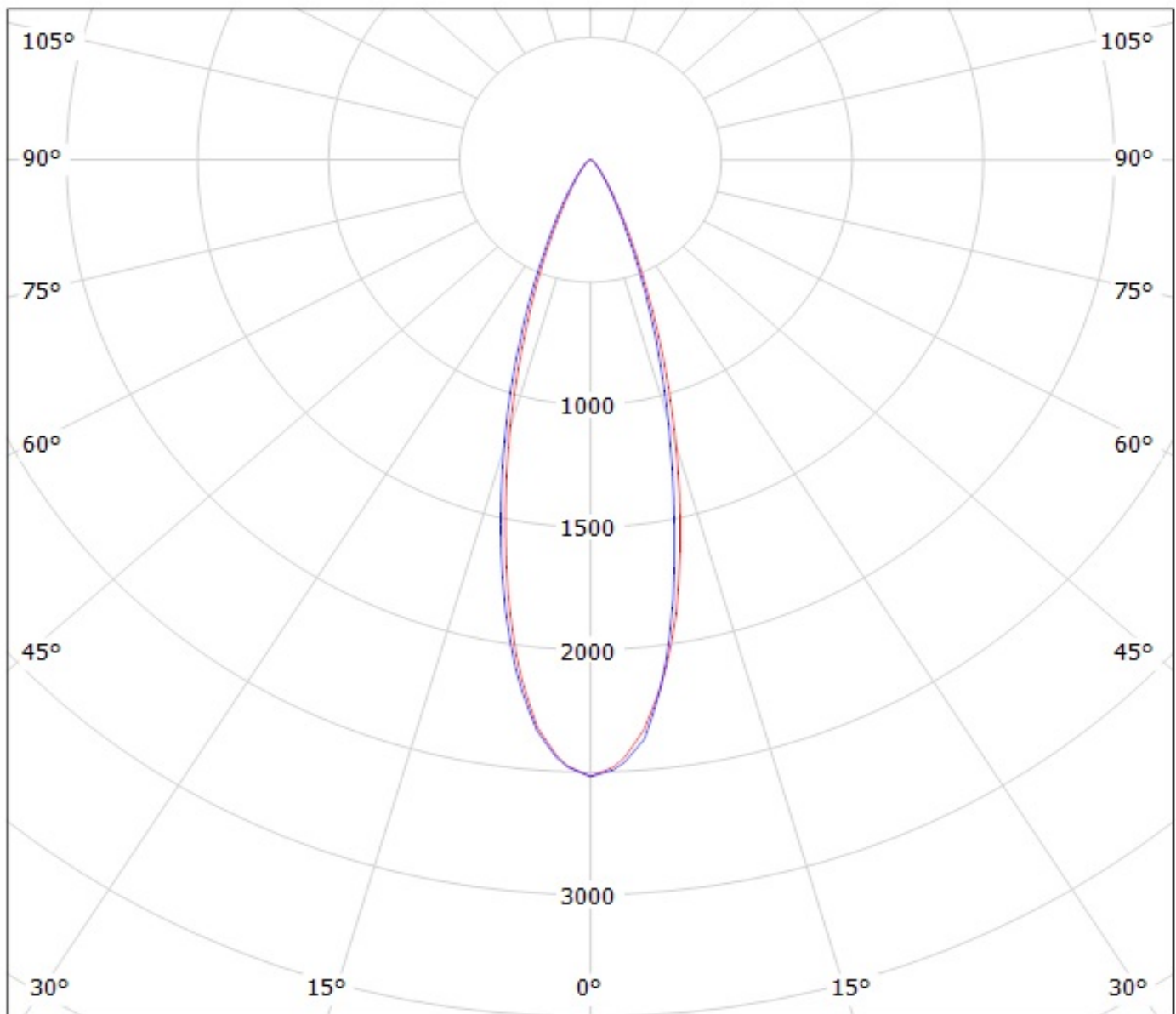

cd/klm

— C0 - C180

— C90 - C270

$\eta = 85\%$

Luminaire: LEDil Oy CA13627\_G2-LAURA-M-P\_(XP-G)

Lamps: 1 x Cree XP-G (XPGWHT\_L1-CWPI-00BE7) 67lm @ 250mA CCT=3061K P=0.75W I=250mA

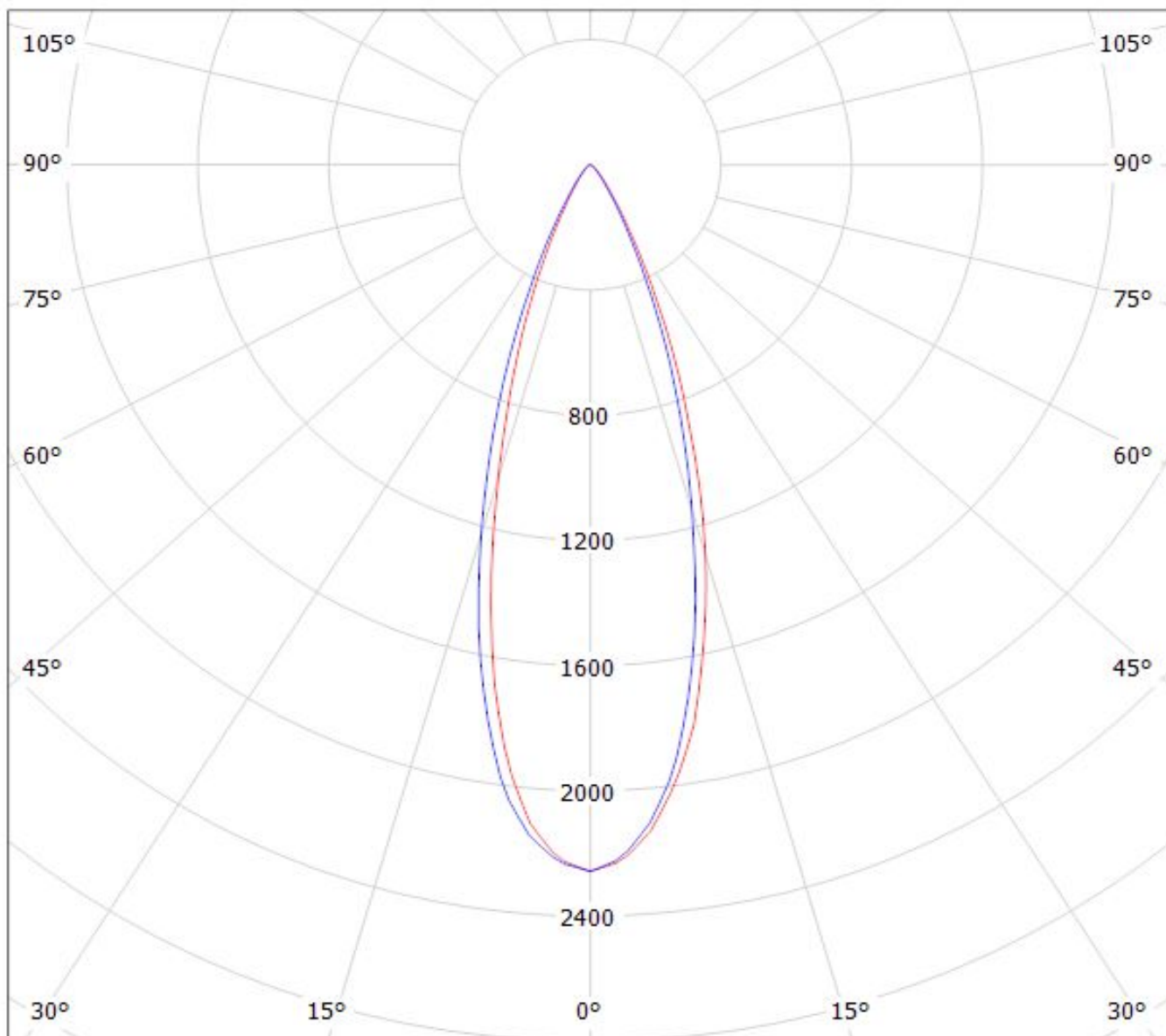

cd/klm

— C0 - C180

— C90 - C270

$\eta = 84\%$

Luminaire: LEDil Oy CA13627\_G2-LAURA-M-P\_(XP-G2)

Lamps: 1 x Cree XP-G2 (XPG $\bar{B}$ WT-L1-0000-00FE4) 100lm @ 250mA CCT=4934K P=0.74w I=250mA

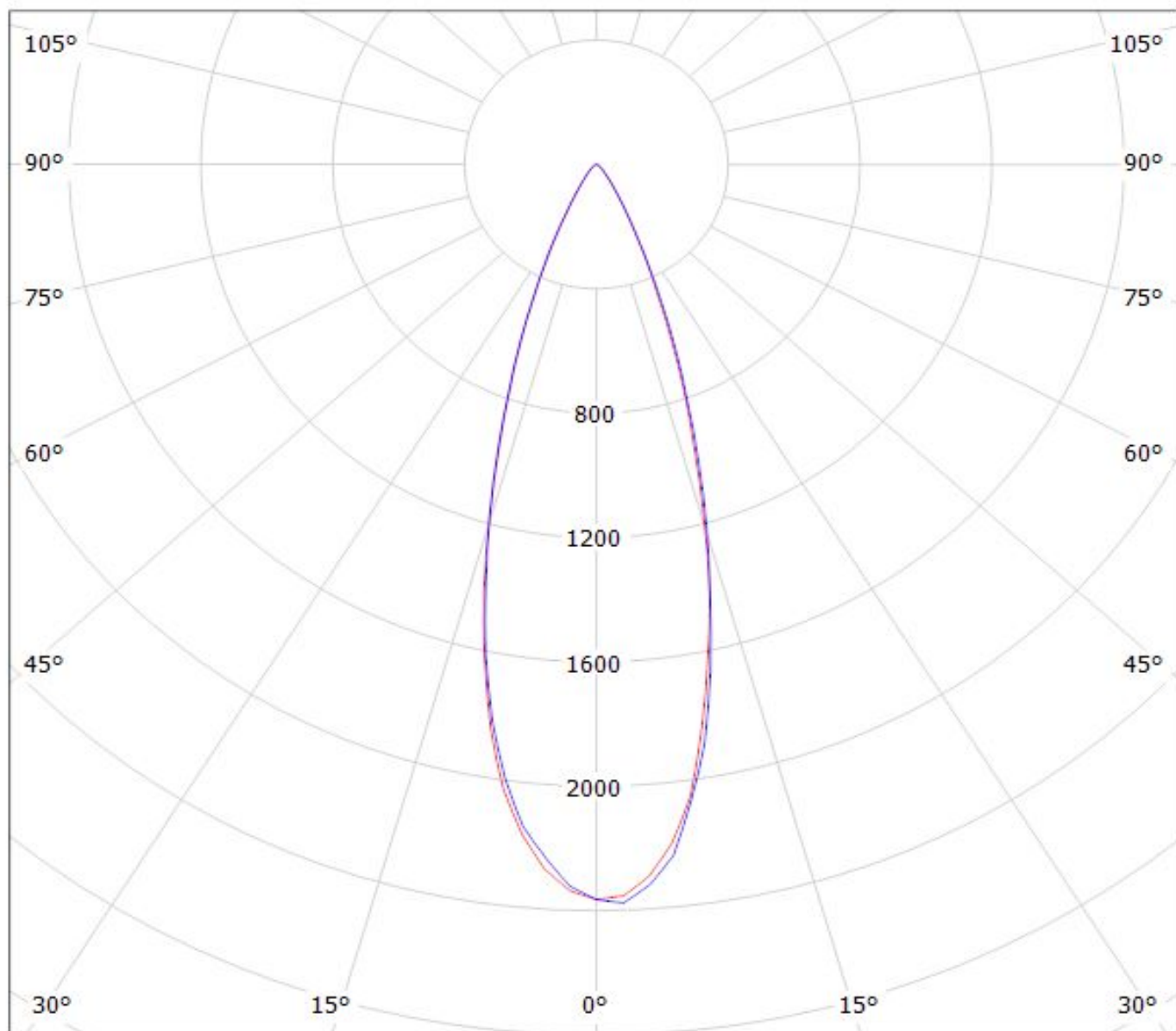

cd/klm

— C0 - C180

— C90 - C270

$\eta = 86\%$

Luminaire: LEDil Oy CA13627\_G2-LAURA-M-P\_(XT-E)

Lamps: 1 x Cree XT-E (XTEAWT-00-0000-00000HBE8) 73.22lm @ 250mA CCT=2800K P=0.8W I=250mA

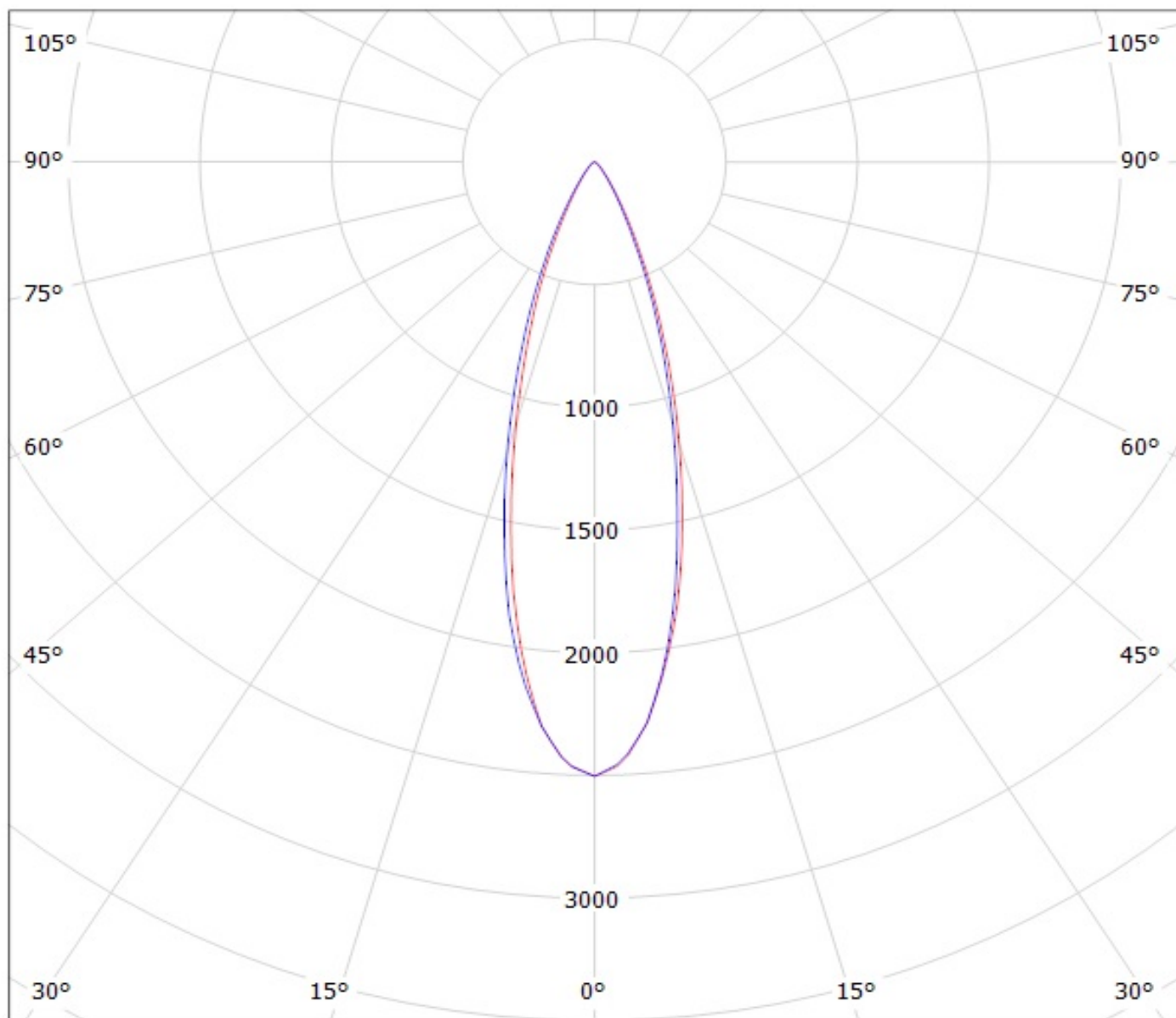

cd/klm

— C0 - C180

— C90 - C270

$\eta = 85\%$

Luminaire: Ledil Oy CA13627\_G2-LAURA-M-P\_(XB-H)

Lamps: 1 x Cree XB-H (XBHAWT-0-3C0-T50-0B-0001) 106lm @ 250mA CCT= P=0.73W I=250mA

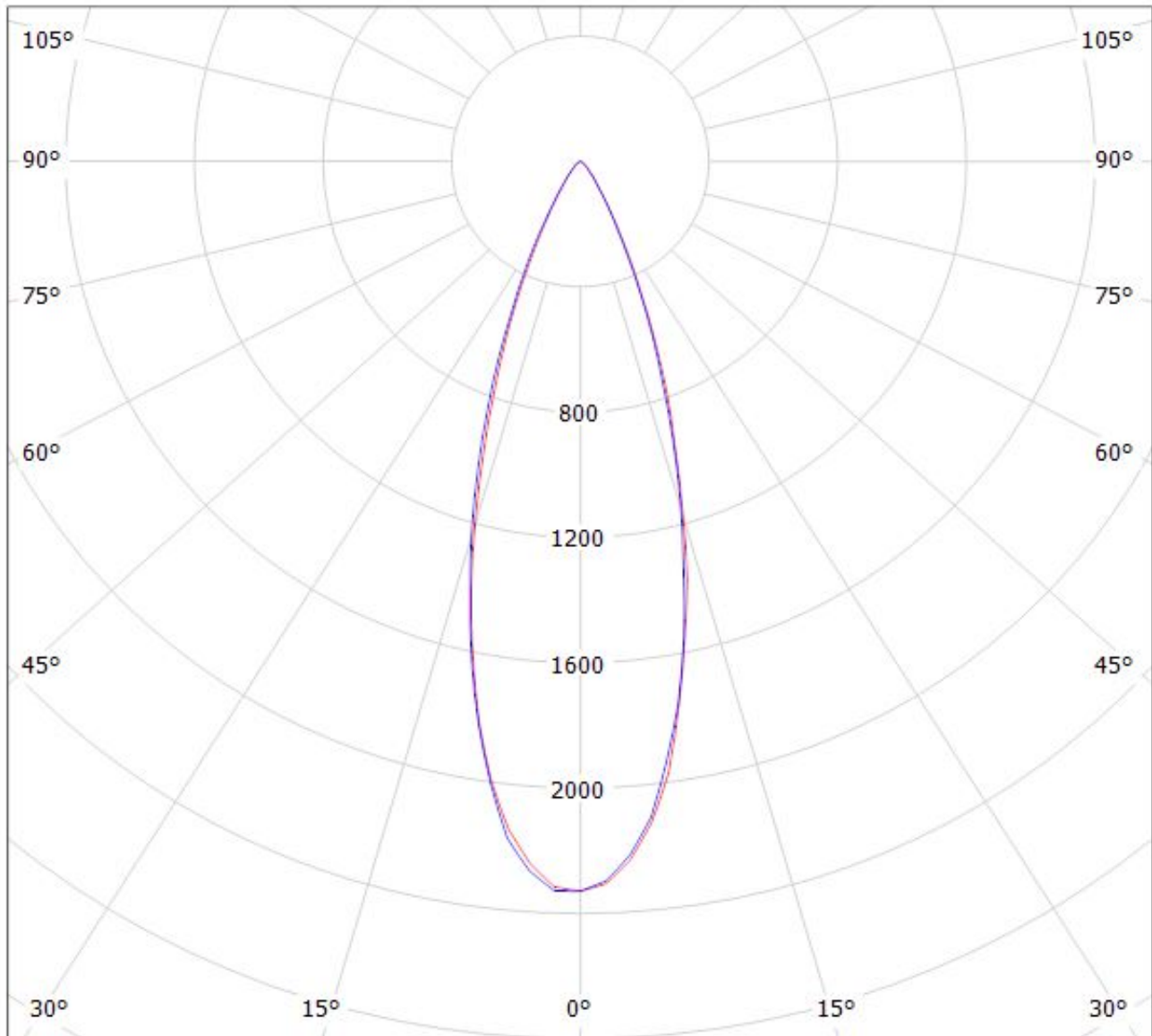

cd/klm

— C0 - C180

— C90 - C270

$\eta = 86\%$



Luminaire: Ledil Oy CA13627\_G2-LAURA-M-P\_(Luxeon\_TX) Efficiency=86%  
Lamps: 1 x Luxeon TX (L1T2-3585) 108lm @ 250mA CCT=3521K P=0.73W I=250mA

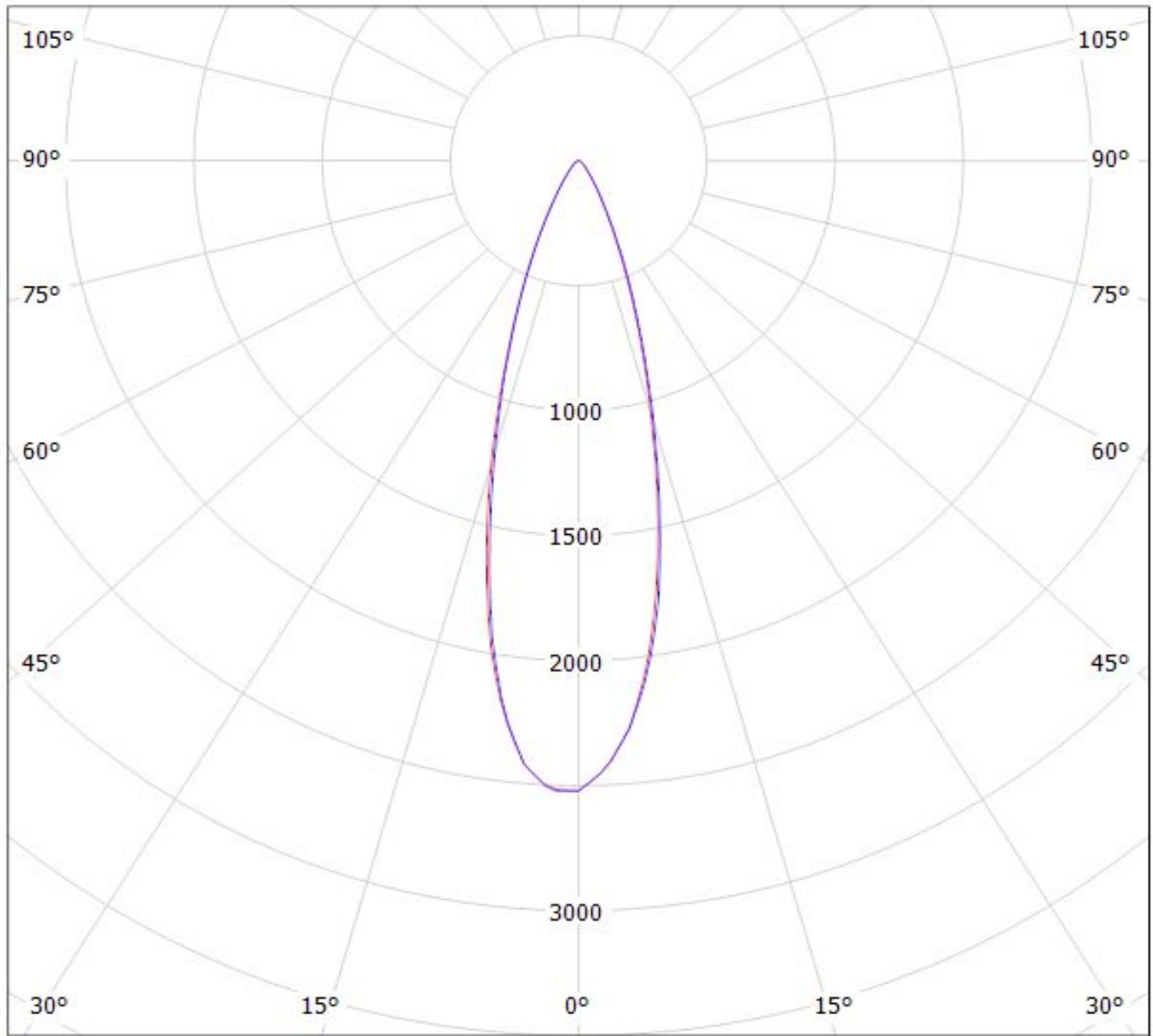

cd/klm

$\eta = 87\%$

— C0 - C180

— C90 - C270

Luminaire: Ledil CA13627\_G2-LAURA-M-P\_(LUXEON\_3030\_2D)

Lamps: 1 x LUXEON\_3030\_2D\_(L130-5080)\_73.2834lm@100mA\_CCT=5000K\_P=0.595784W\_I=0.1A

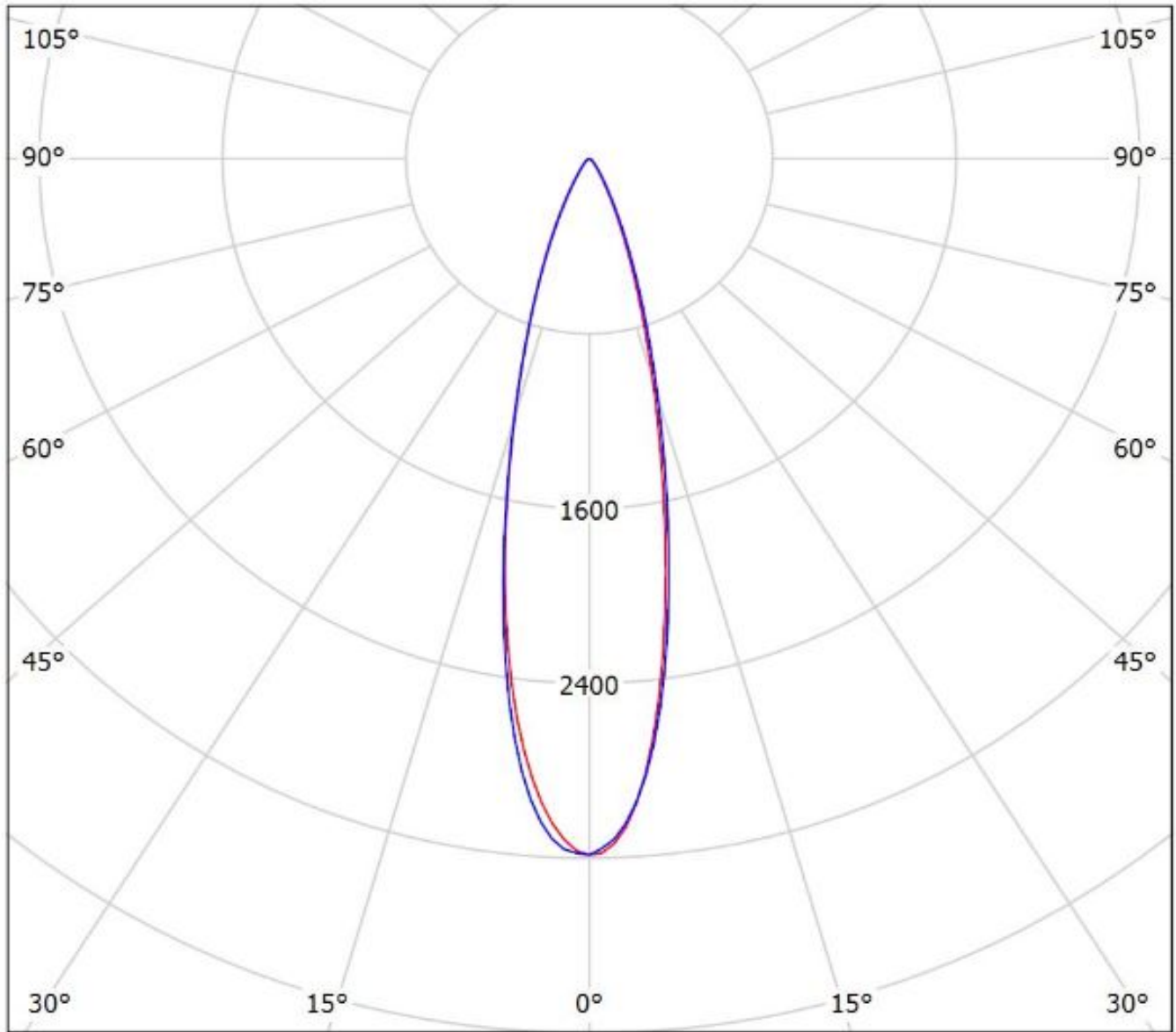

cd/klm

— C0 - C180

— C90 - C270

$\eta = 85\%$



Luminaire: LEDiL CA13627\_G2-LAURA-M-P\_(NCS19)

Lamps: 1 x Nichia NCSxx19A 65lm @ 250mA CCT= P=0.77W I=250mA

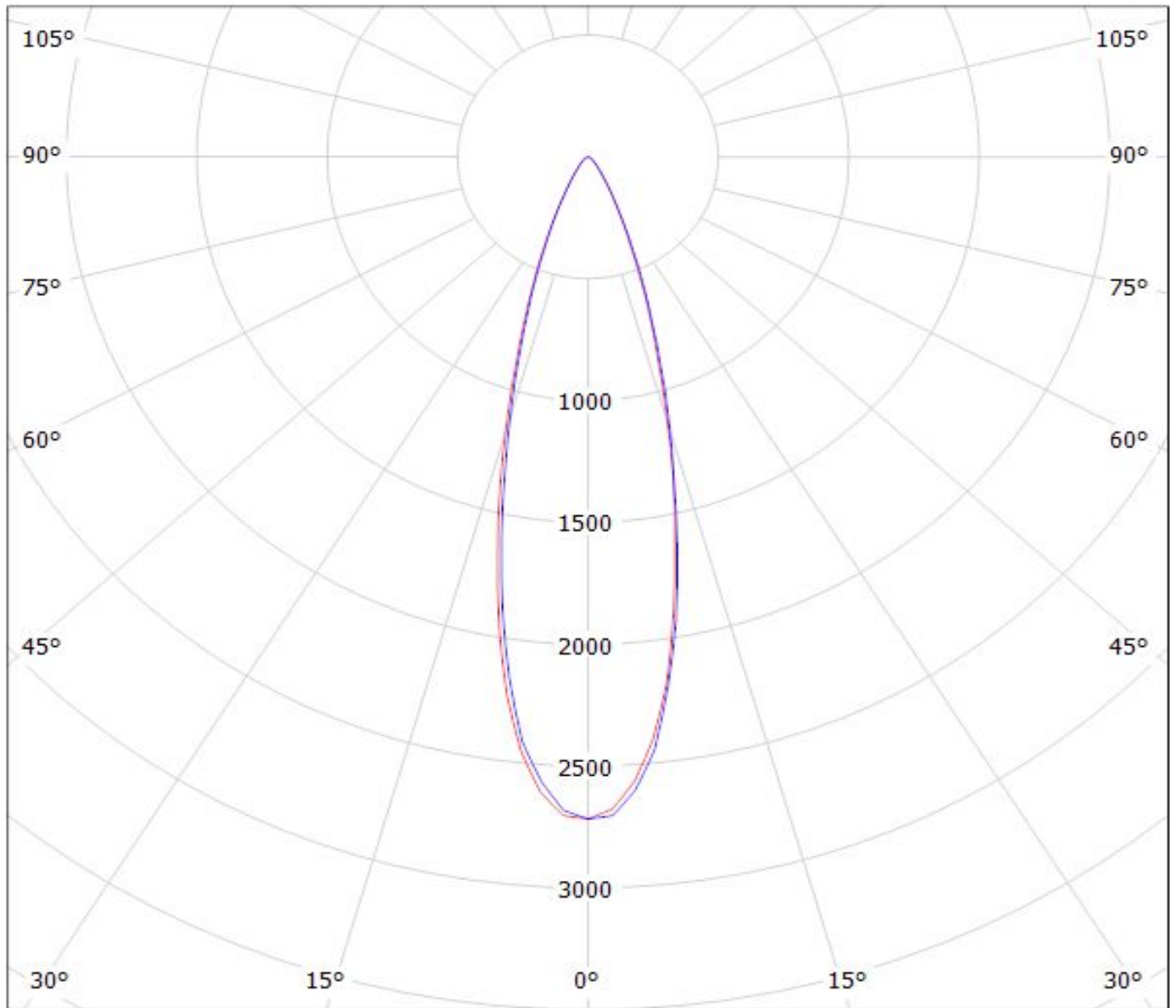

cd/klm

— C0 - C180

— C90 - C270

$\eta = 87\%$

Luminaire: Ledil Oy CA13627\_G2-LAURA-M-P\_(NVS19)

Lamps: 1 x Nichia NVSxx19A 93lm @ 250mA CCT=5010K P=0.75W I=250mA

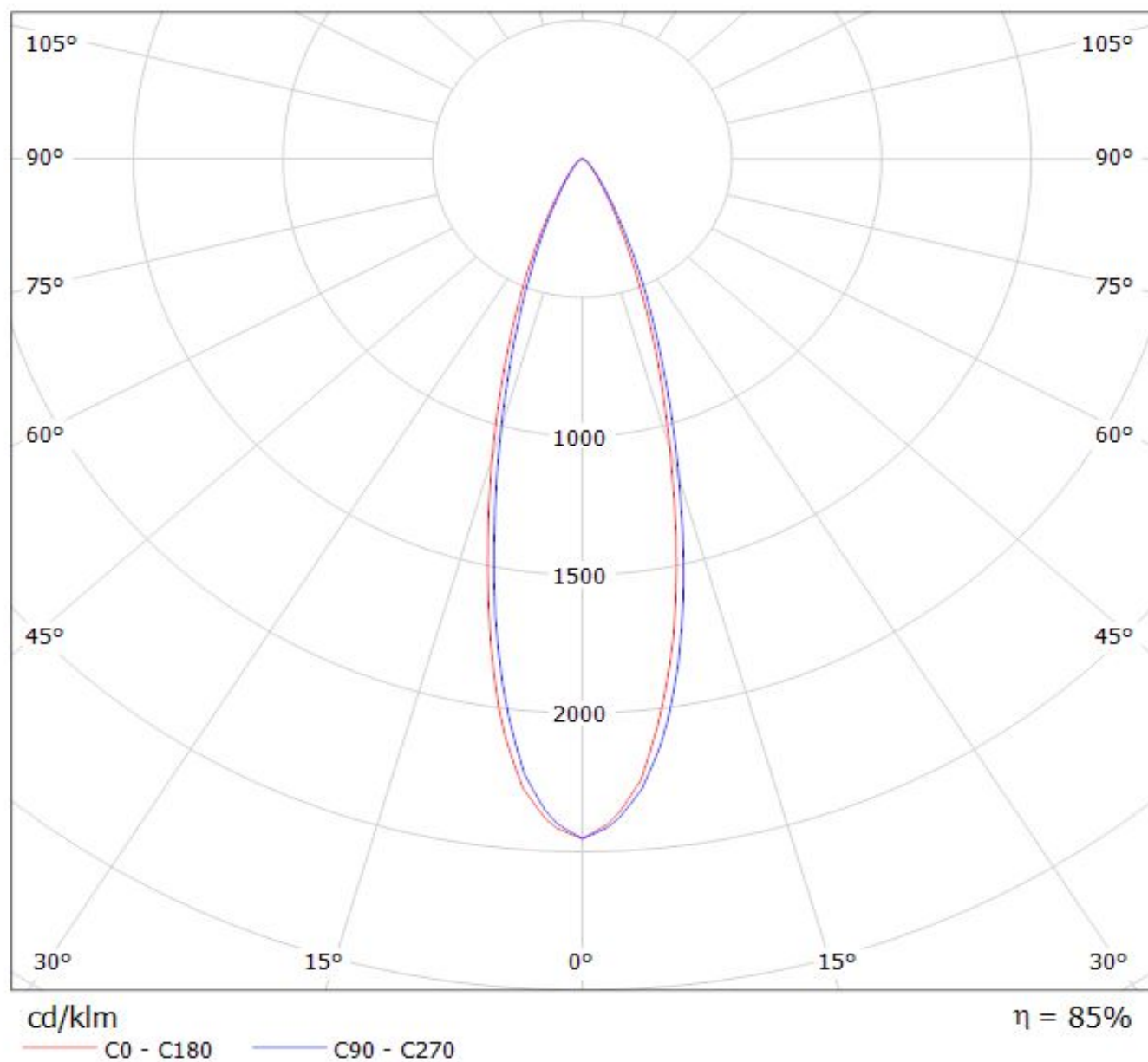

Luminaire: LEDil Oy CA13627\_G2-LAURA-M-P\_(Oslon\_Square\_EC)

Lamps: 1 x Osram Oslon Square EC (LCW CQAR-EC-MQMS-5R8T-35) 77.57lm @ 250mA CCT=3226K P=0.8W I=250mA

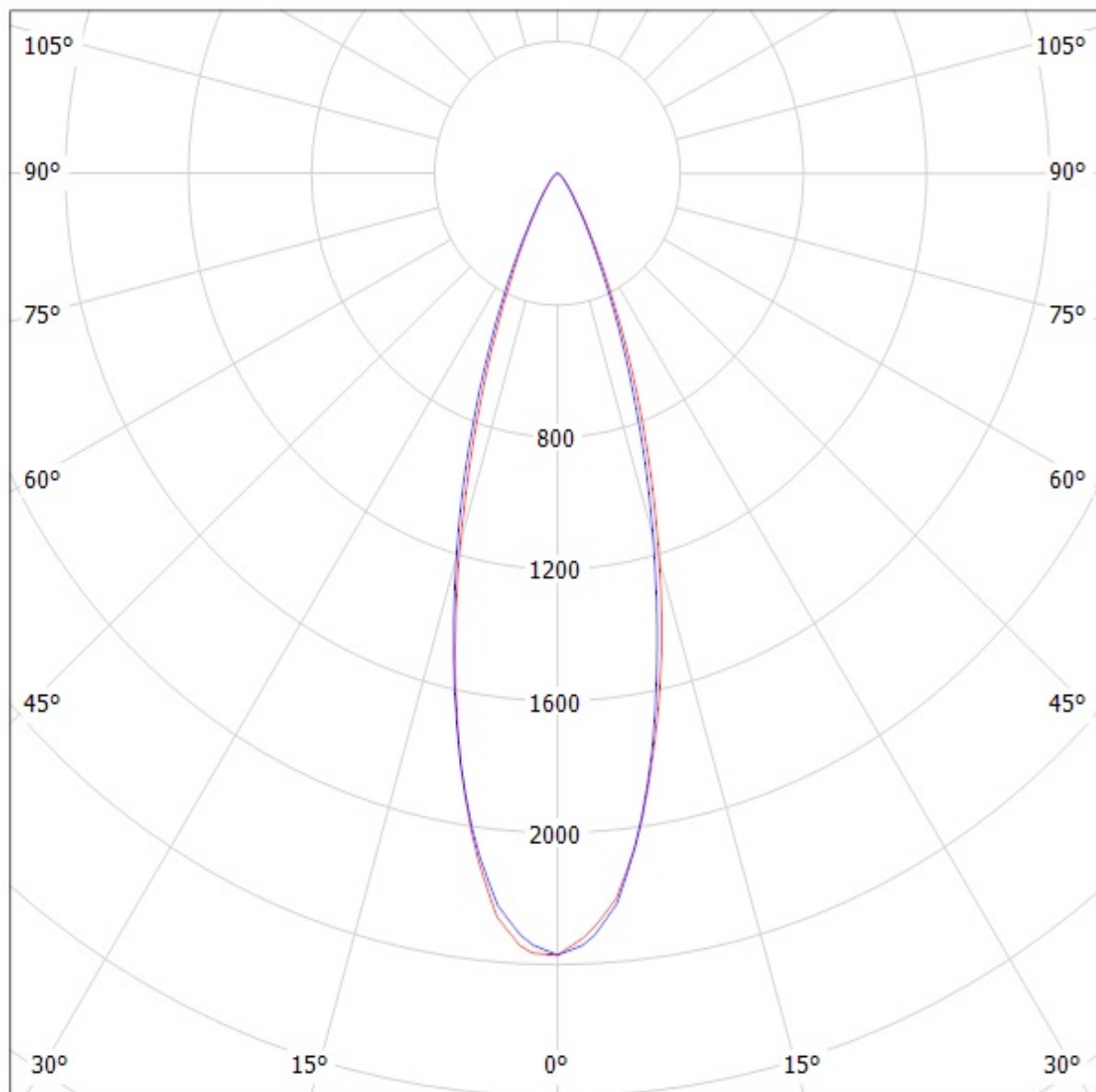

cd/klm

— C0 - C180 — C90 - C270

$\eta = 85\%$

# Ledil CA13627\_G2-LAURA-M-P\_(SQ-PC) / LDC (Polar)

Luminaire: Ledil CA13627\_G2-LAURA-M-P\_(SQ-PC)

Lamps: 1 x Osram\_Oslon\_Square-PC\_(LCW\_CQAR.PL-MSMV-SH71-1)

\_103.48lm@250mA\_CCT=5913K\_P=0.8W\_I=0.25A

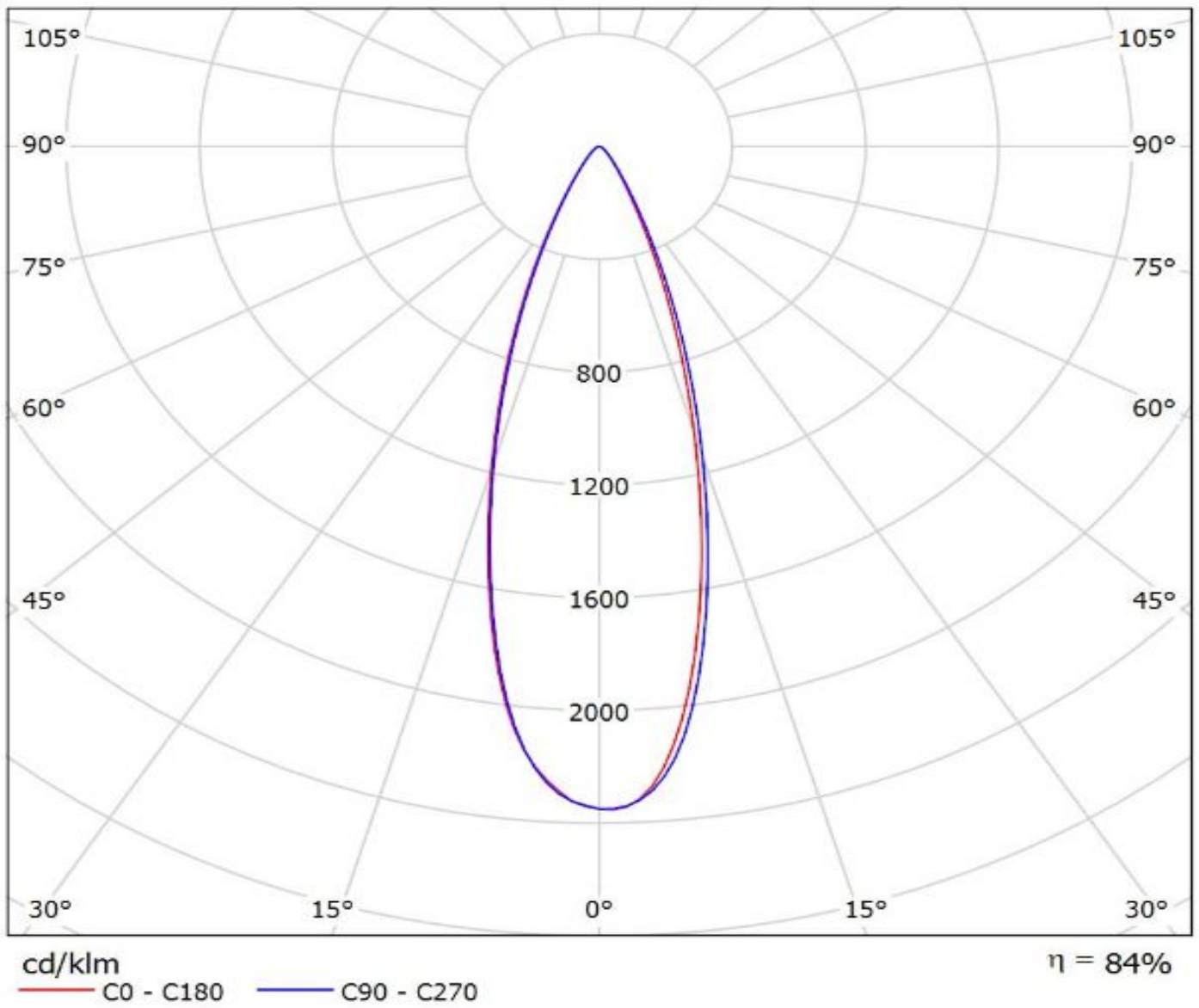

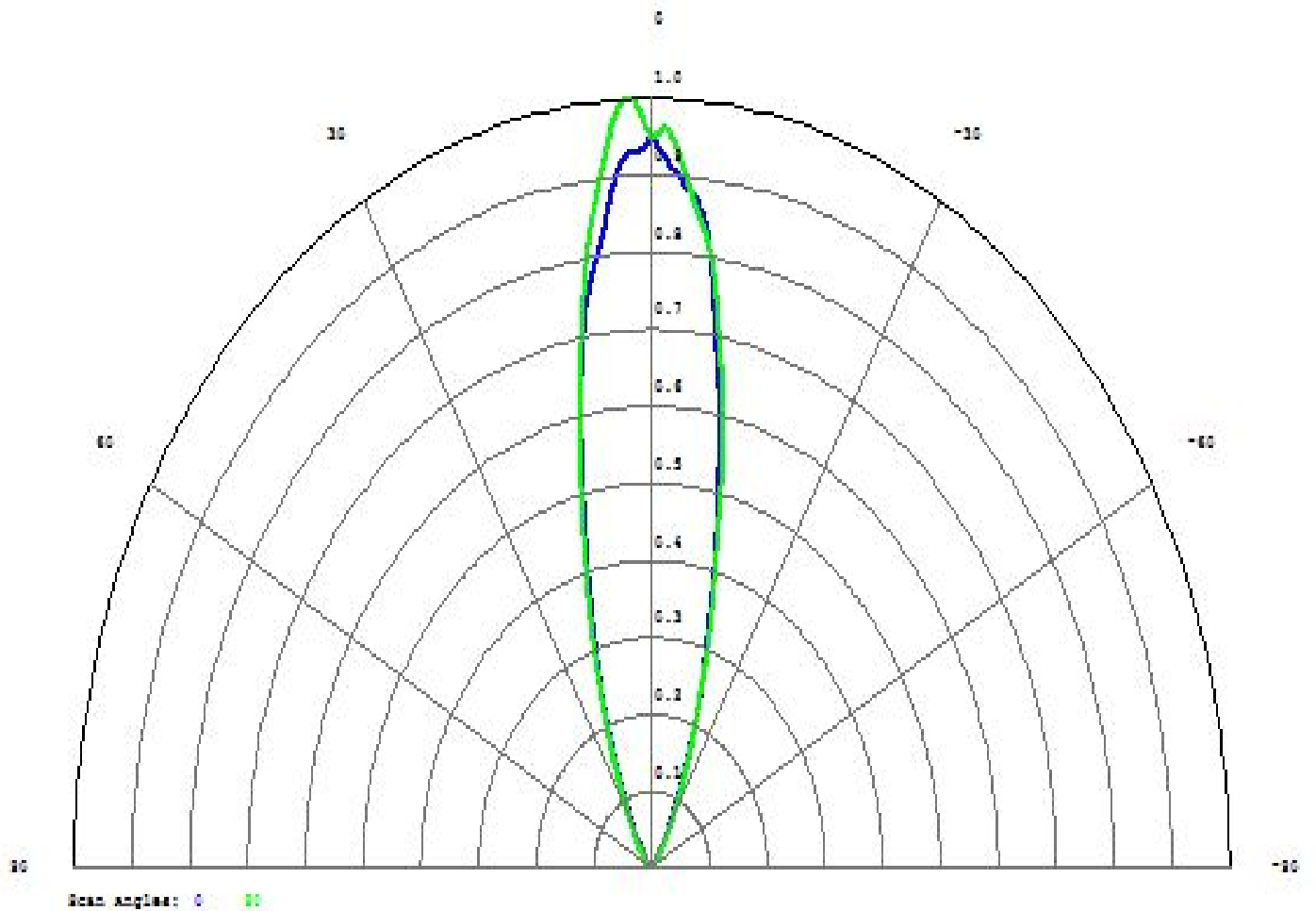

---

Detector Image: Radiant Intensity

---

8.4.2016  
 Detector 3, NSCG Surface 1:  
 Scan Angles: 0, 90  
 Peak Intensity : 2.899E+000 Watts/Steradian

---

CA13627 G2-LAURA-M-P\_SFH\_47705.ZMX  
 Configuration 1 of 1

---

Luminaire: Ledil Oy CA13627\_G2-LAURA-M-P\_(Oslon\_Black\_Flat)\_SIMULATED  
Lamps: 1 x Osram Oslon Black Flat (LUW HWQP)

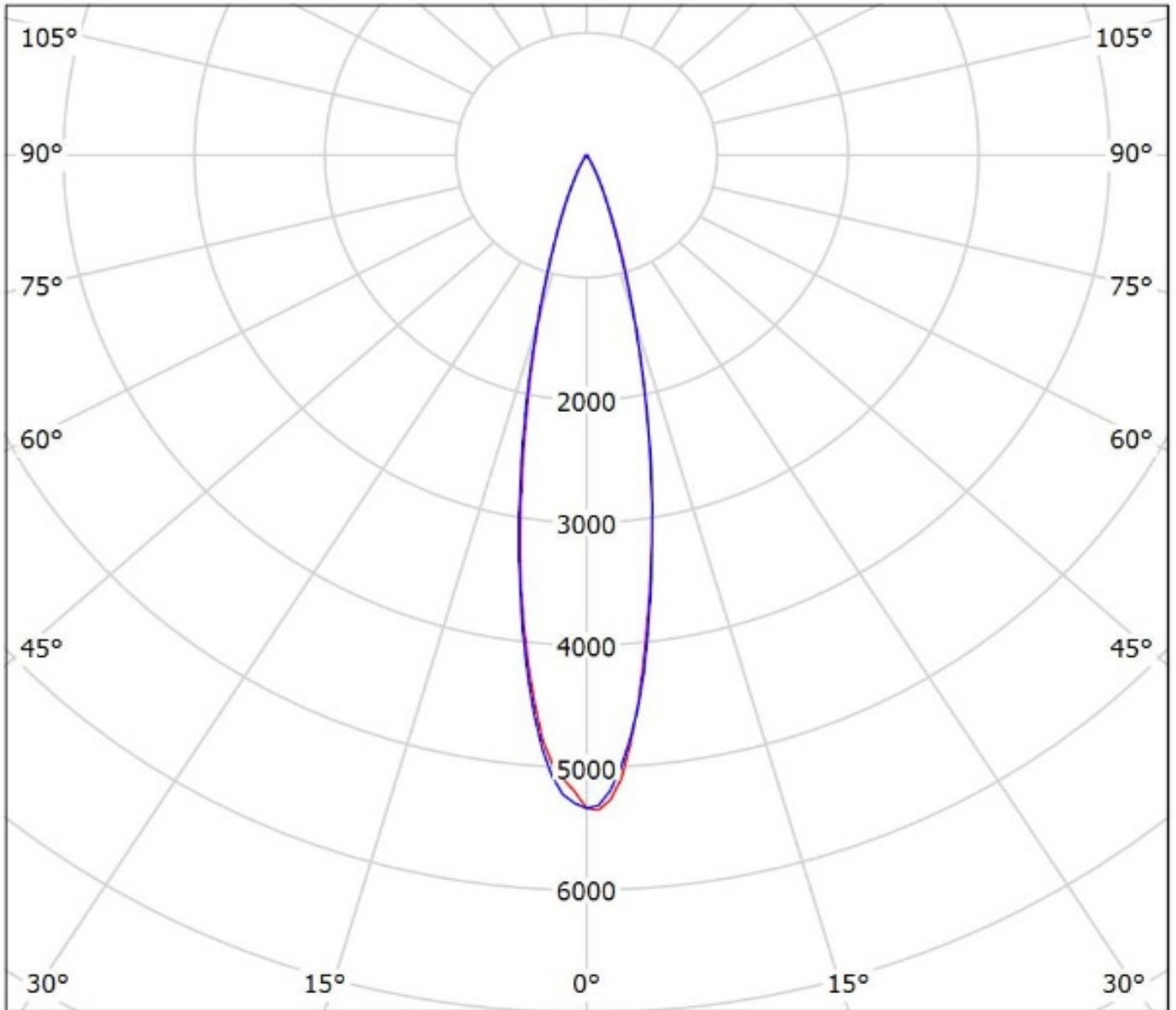

cd/klm

— C0 - C180 — C90 - C270

$\eta = 94\%$

Luminaire: Ledil CA13627\_G2-LAURA-M-P\_(Z5M1)

Lamps: 1 x Seoul\_Z5M1\_(SZ5-M1-W0-C8)\_110.161lm@250mA\_P=0.7398W\_I=0.250A

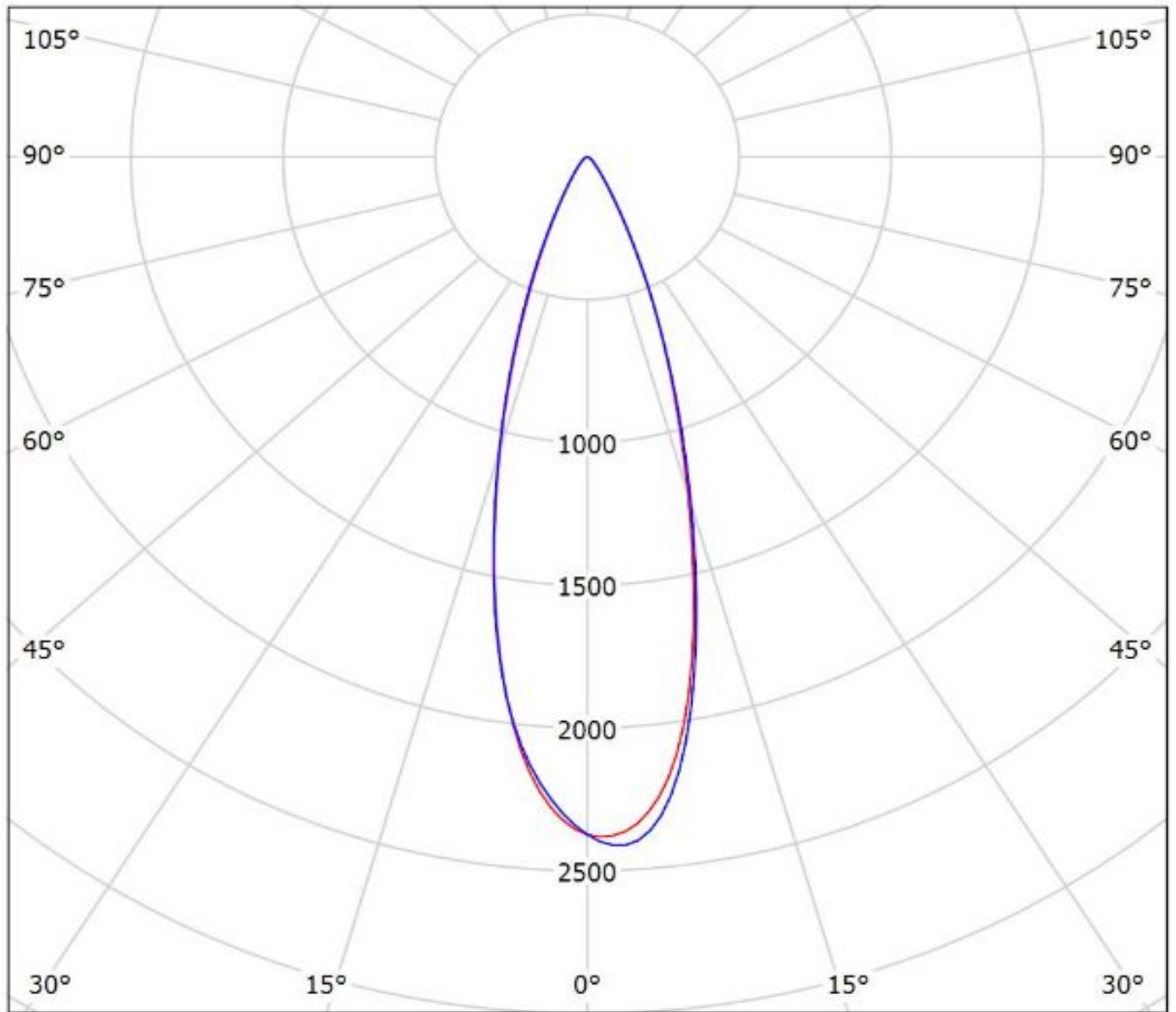

cd/klm

— C0 - C180

— C90 - C270

$\eta = 84\%$



Luminaire: Ledil Oy CA13627\_G2-LAURA-M-P\_Seoul\_Z8Y22P\_SIMULATED  
Lamps: 1 x Seoul Z8Y22P

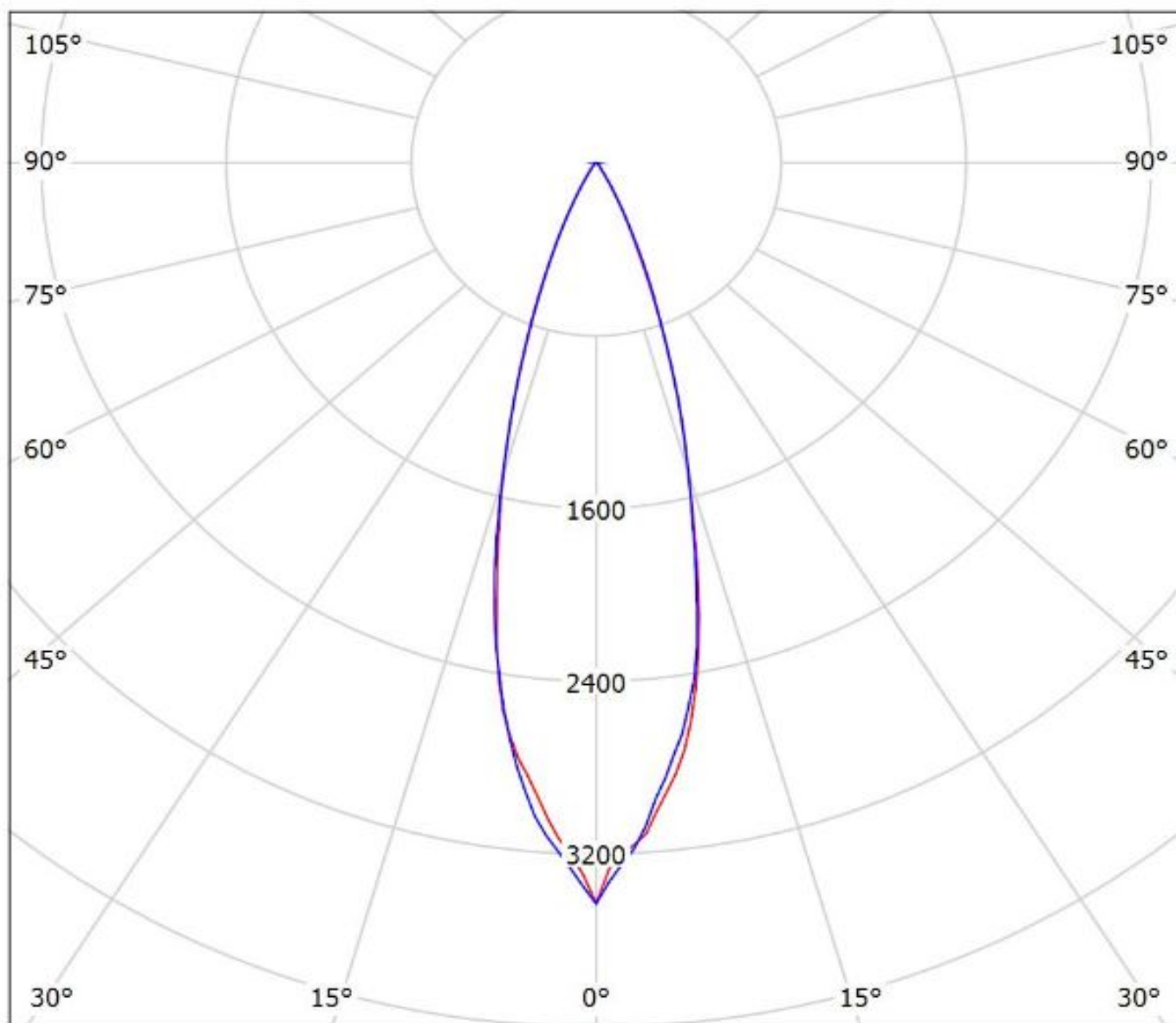

cd/klm  
— C0 - C180 — C90 - C270

$\eta = 96\%$



**NOTE: The typical divergence will be changed by different color, chip size and chip position tolerance. The typical total divergence is the full angle measured where the luminous intensity is half of the peak value.**