

## 1μA I<sub>Q</sub>, 250mA Low-Dropout Linear Regulator

### General Description

The RT9073A is a low-dropout (LDO) voltage regulators with enable function that operates from 1.2V to 5.5V. It provides up to 250mA of output current and offers low-power operation in miniaturized packaging.

The features of low quiescent current as low as 1μA and almost zero disable current is ideal for powering the battery equipment to a longer service life. The RT9073A is stable with the ceramic output capacitor over its wide input range from 1.2V to 5.5V and the entire range of output load current (0mA to 250mA).

### Ordering Information

RT9073A-□□□□	
	Package Type
	QZ : ZQFN-4L 1x1 (Z-Type)
	(ZDFN-4L 1x1)
	Y : SC-82
	Lead Plating System
	G : Green (Halogen Free and Pb Free)
	Output Voltage
	09 : 0.9V
	1K : 1.05V
	12 : 1.2V
	15 : 1.5V
	18 : 1.8V
	19 : 1.9V
	25 : 2.5V
	27 : 2.7V
	28 : 2.8V
	29 : 2.9V
	30 : 3.0V
	33 : 3.3V
	Special Request: Any Voltage
	Between 0.9V and 3.3V under
	specific business agreement

Note :

Richtek products are :

- ▶ RoHS compliant and compatible with the current requirements of IPC/JEDEC J-STD-020.
- ▶ Suitable for use in SnPb or Pb-free soldering processes.

### Features

- 1μA Ground Current at no Load
- PSRR = 75dB at 1kHz
- ±2% Output Accuracy
- 250mA (V<sub>IN</sub> ≥ 2.3V) Output Current with EN
- Low (0.1μA) Disable Current
- 1.2V to 5.5V Operating Input Voltage
- Dropout Voltage : 0.5V at 250mA when V<sub>OUT</sub> ≥ 3V
- Support Fixed Output Voltage 0.9V, 1.05V, 1.2V, 1.5V, 1.8V, 1.9V, 2.5V, 2.7V, 2.8V, 2.9V, 3V, 3.3V
- Stable with Ceramic or Tantalum Capacitor
- Current Limit Protection
- Over Temperature Protection
- ZQFN-4L 1x1 (ZDFN-4L 1x1), SC-82 Packages Available

### Applications

- Portable, Battery Powered Equipment
- Ultra Low Power Microcontrollers
- Notebook computers

### Marking Information

For marking information, contact our sales representative directly or through a Richtek distributor located in your area.

## Pin Configurations

(TOP VIEW)

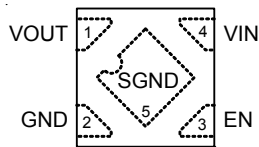

ZQFN-4L 1x1 (ZDFN-4L 1x1)

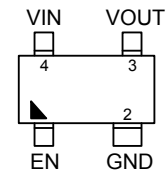

SC-82 (SSOT-24)

## Functional Pin Description

Pin No.		Pin Name	Pin Function
ZQFN-4L 1x1 (ZDFN-4L 1x1)	SC-82 (SSOT-24)		
1	3	VOUT	Output of the Regulator.
2	2	GND	Ground.
3	1	EN	Enable Control Input.
4	4	VIN	Supply Voltage Input.
5 (Exposed Pad)	--	SGND	Substrate of Chip. Leave floating or tie to GND.

## Function Block Diagram

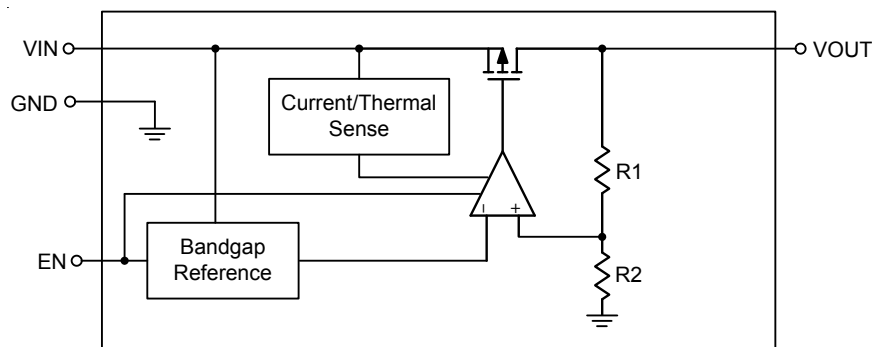

## Operation

### Basic operation

The RT9073A is a low quiescent current linear regulator designed especially for low external components system. The input voltage range is from 1.2V to 5.5V.

The minimum required output capacitance for stable operation is 1 $\mu$ F effective capacitance after consideration of the temperature and voltage coefficient of the capacitor.

### Output Transistor

The RT9073A builds in a P-MOSFET output transistor which provides a low switch-on resistance for low dropout voltage applications.

### Error Amplifier

The Error Amplifier compares the internal reference voltage with the output feedback voltage from the internal divider, and controls the Gate voltage of P-MOSFET to support good line regulation and load regulation at output voltage.

### Enable

The RT9073A delivers the output power when it is set to enable state. When it works in disable state, there is no output power and the operation quiescent current is almost zero.

### Current Limit Protection

The RT9073A provides current limit function to prevent the device from damages during over-load or shorted-circuit condition. This current is detected by an internal sensing transistor.

### Over Temperature Protection

The over temperature protection function will turn off the P-MOSFET when the junction temperature exceeds 150°C (typ.),  $V_{IN} \geq 1.5V$  and the output current exceeds 30mA. Once the junction temperature cools down by approximately 20°C, the regulator will automatically resume operation.

## Absolute Maximum Ratings (Note 1)

- VIN, VOUT, EN to GND ----- -0.3V to 6.5V
- VOUT to VIN ----- -6.5V to 0.3V
- Power Dissipation,  $P_D$  @  $T_A = 25^\circ\text{C}$ 
  - ZQFN-4L 1x1 (ZDFN-4L 1x1) ----- 0.44W
  - SC-82 ----- 0.28W
- Package Thermal Resistance (Note 2)
  - ZQFN-4L 1x1 (ZDFN-4L 1x1),  $\theta_{JA}$  -----  $226^\circ\text{C/W}$
  - ZQFN-4L 1x1 (ZDFN-4L 1x1),  $\theta_{JC}$  -----  $43^\circ\text{C/W}$
  - SC-82,  $\theta_{JA}$  -----  $345.6^\circ\text{C/W}$
- Lead Temperature (Soldering, 10 sec.) -----  $260^\circ\text{C}$
- Junction Temperature -----  $150^\circ\text{C}$
- Storage Temperature Range -----  $-65^\circ\text{C}$  to  $150^\circ\text{C}$
- ESD Susceptibility (Note 3)
  - HBM (Human Body Model) ----- 2kV
  - MM (Machine Model) ----- 200V

## Recommended Operating Conditions (Note 4)

- Input Voltage, VIN ----- 1.2V to 5.5V
- Junction Temperature Range -----  $-40^\circ\text{C}$  to  $125^\circ\text{C}$
- Ambient Temperature Range -----  $-40^\circ\text{C}$  to  $85^\circ\text{C}$

## Electrical Characteristics

( $V_{OUT} + 1 < V_{IN} < 5.5\text{V}$ ,  $T_A = 25^\circ\text{C}$ , unless otherwise specified)

Parameter	Symbol	Test Conditions	Min	Typ	Max	Unit
Output Voltage Range	$V_{OUT}$		0.9	--	3.3	V
DC Output Accuracy		$I_{LOAD} = 1\text{mA}$	-2	--	2	%
Dropout Voltage ( $I_{LOAD} = 50\text{mA}$ ) (Note 5)	$V_{DROP}$	$0.9\text{V} \leq V_{OUT} < 1.2\text{V}$	--	0.5	0.65	V
		$1.2\text{V} \leq V_{OUT} < 1.5\text{V}$	--	0.3	0.4	
		$1.5\text{V} \leq V_{OUT} < 1.8\text{V}$	--	0.2	0.24	
		$1.8\text{V} \leq V_{OUT} < 2.5\text{V}$	--	0.15	0.18	
		$2.5\text{V} \leq V_{OUT} < 3\text{V}$	--	0.1	0.15	
		$3\text{V} \leq V_{OUT}$	--	0.08	0.12	
Dropout Voltage ( $I_{LOAD} = 250\text{mA}$ ) (Note 5)	$V_{DROP}$	$0.9\text{V} \leq V_{OUT} < 1.2\text{V}$	--	1.25	1.45	V
		$1.2\text{V} \leq V_{OUT} < 1.5\text{V}$	--	1	1.2	
		$1.5\text{V} \leq V_{OUT} < 1.8\text{V}$	--	0.81	0.9	
		$1.8\text{V} \leq V_{OUT} < 2.5\text{V}$	--	0.68	0.8	
		$2.5\text{V} \leq V_{OUT} < 3\text{V}$	--	0.51	0.6	
		$3\text{V} \leq V_{OUT}$	--	0.45	0.6	
$V_{CC}$ Consumption Current	$I_Q$	$I_{LOAD} = 0\text{mA}$ , $V_{OUT} \leq 5.5\text{V}$	--	1	3	$\mu\text{A}$

Parameter	Symbol	Test Conditions	Min	Typ	Max	Unit	
Shutdown GND Current		$V_{EN} = 0V$	--	0.1	0.5	$\mu A$	
Shutdown Leakage Current		$V_{EN} = 0V, V_{OUT} = 0V$	--	0.1	0.5	$\mu A$	
EN Input Current	$I_{EN}$	$V_{EN} = 5.5V$	--	--	0.1	$\mu A$	
Line Regulation	$\Delta LINE$	$I_{LOAD} = 10mA$	$1.2V \leq V_{IN} < 1.5V$	--	--	0.6	%
			$1.5V \leq V_{IN} < 1.8V$	--	--	0.3	
			$1.8V \leq V_{IN} < 2.1V$	--	--	0.1	
			$2.1V \leq V_{IN} \leq 5.5V$	--	--	0.15	
Load Regulation	$\Delta LOAD$	$1mA < I_{LOAD} < 200mA$	--	--	1	%	
Power Supply Rejection Ratio	PSRR	$V_{IN} = 3V, I_{LOAD} = 50mA, C_{OUT} = 1\mu F, V_{OUT} = 2.5V, f = 1kHz$	--	75	--	dB	
Output Voltage Noise		$C_{OUT} = 1\mu F, I_{LOAD} = 30mA, BW = 10Hz \text{ to } 100kHz, V_{IN} = V_{OUT} + 2V$	$V_{OUT} = 0.9V$	--	39	--	$\mu V_{RMS}$
			$V_{OUT} = 1.2V$	--	46	--	
			$V_{OUT} = 1.8V$	--	48	--	
			$V_{OUT} = 3.3V$	--	58	--	
Output Current Limit	$I_{LIM}$	Peak output current	260	350	500	mA	
Fold-Back Current Limit		$V_{OUT} = 0.5 \times V_{OUT(normal)}$	190	270	350	mA	
Enable Input Voltage	Logic-High	$V_{IH}$	$V_{IN} = 5V$	1.2	--	--	V
	Logic-Low	$V_{IL}$	$V_{IN} = 5V$	--	--	0.4	
Thermal Shutdown Temperature	$T_{SD}$	$I_{LOAD} = 30mA, V_{IN} \geq 1.5V$	--	150	--	$^{\circ}C$	
Thermal Shutdown Hysteresis	$\Delta T_{SD}$		--	20	--	$^{\circ}C$	

**Note 1.** Stresses beyond those listed “Absolute Maximum Ratings” may cause permanent damage to the device. These are stress ratings only, and functional operation of the device at these or any other conditions beyond those indicated in the operational sections of the specifications is not implied. Exposure to absolute maximum rating conditions may affect device reliability.

**Note 2.**  $\theta_{JA}$  is measured in the natural convection at  $T_A = 25^{\circ}C$  on a two-layer Richtek Evaluation Board for ZQFN-4L 1x1 (ZDFN-4L 1x1) Package.

$\theta_{JA}$  is measured at  $T_A = 25^{\circ}C$  on a high effective thermal conductivity four-layer test board per JEDEC 51-7 for SC-82 Package.

**Note 3.** Devices are ESD sensitive. Handling precaution is recommended.

**Note 4.** The device is not guaranteed to function outside its operating conditions.

**Note 5.** The dropout voltage is defined as  $V_{IN} - V_{OUT}$ , when  $V_{OUT}$  is 98% of the normal value of  $V_{OUT}$ .

## Typical Application Circuit

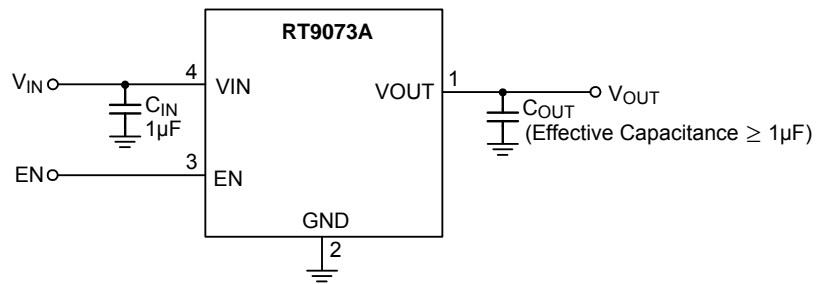

**Typical Operating Characteristics**

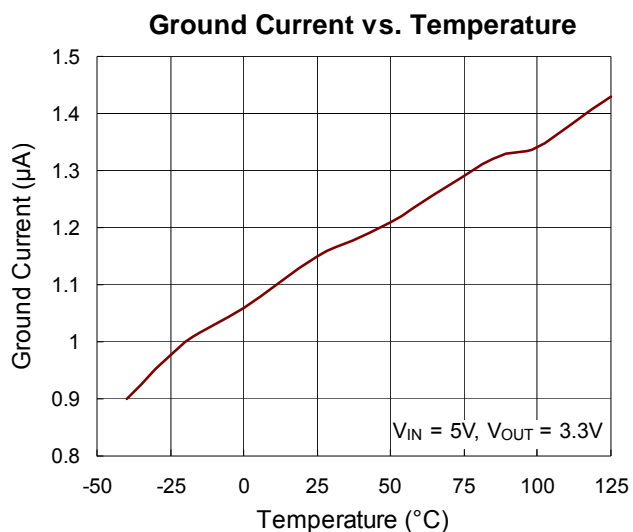
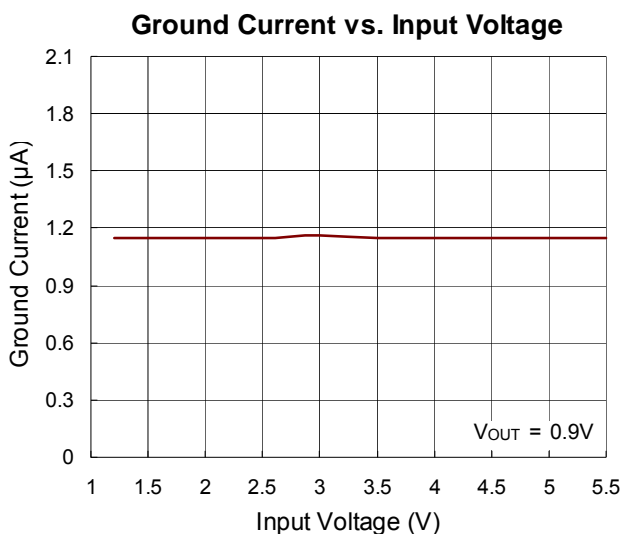
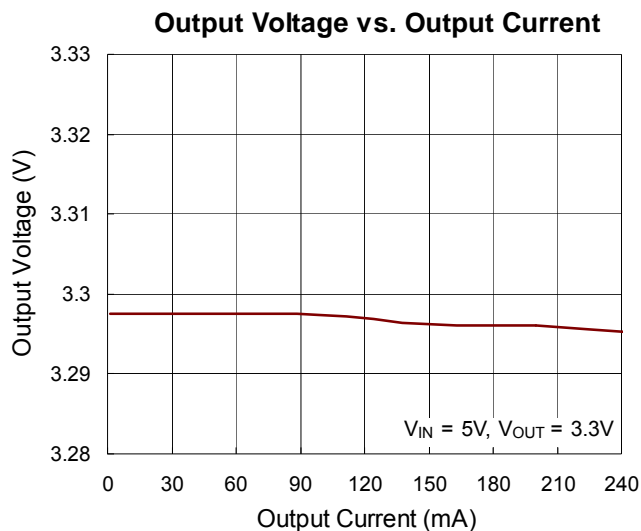
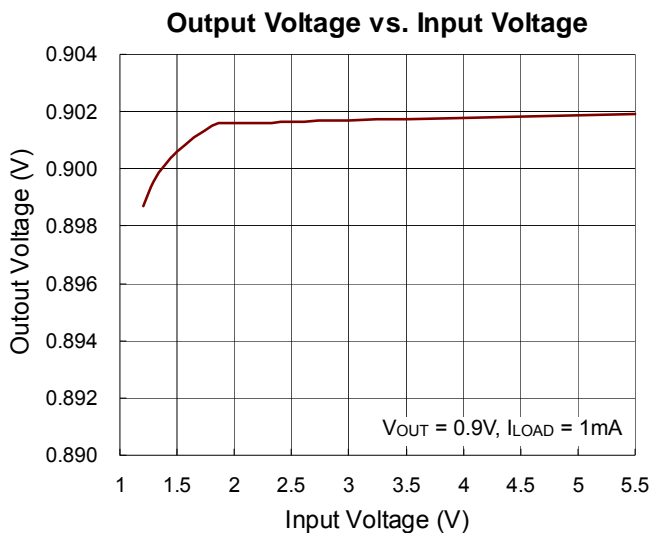
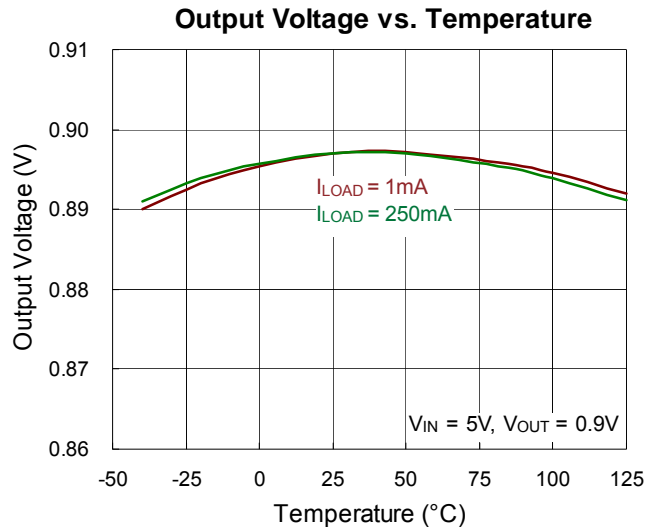
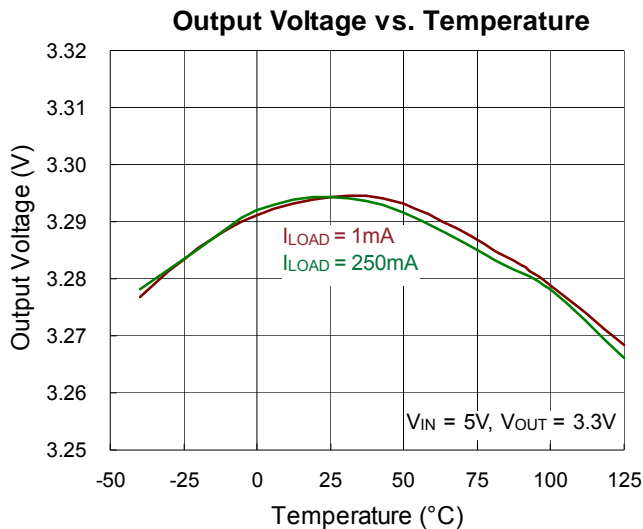

Shutdown Current vs. Input Voltage

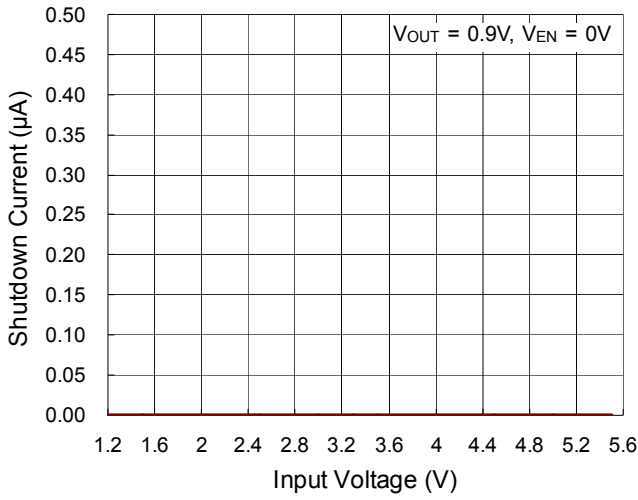

Shutdown Current vs. Temperature

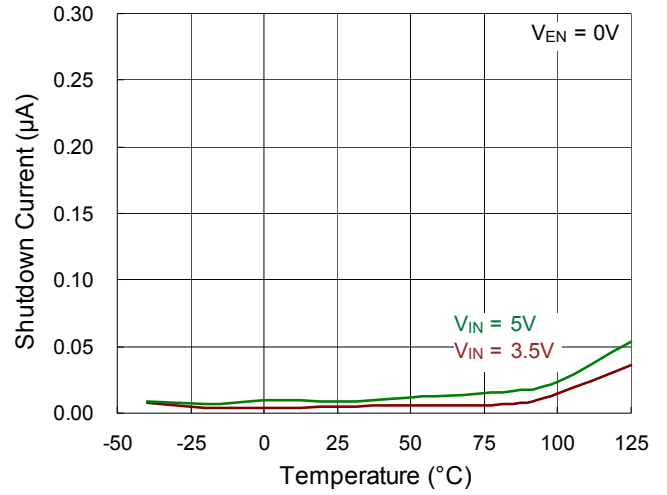

EN Threshold vs. Input Voltage

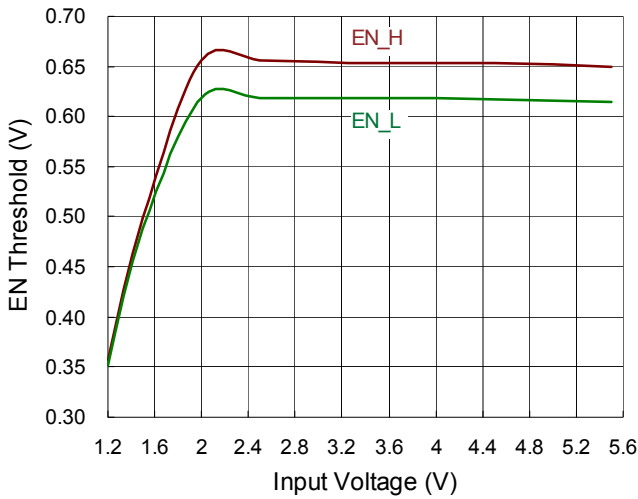

EN Threshold vs. Temperature

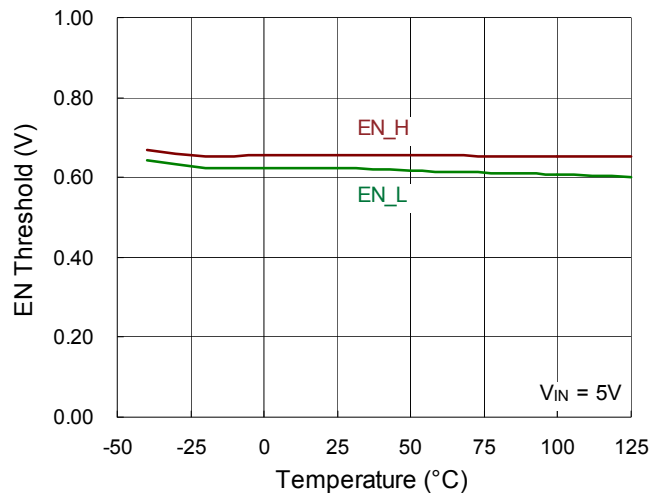

Dropout Voltage vs. Temperature

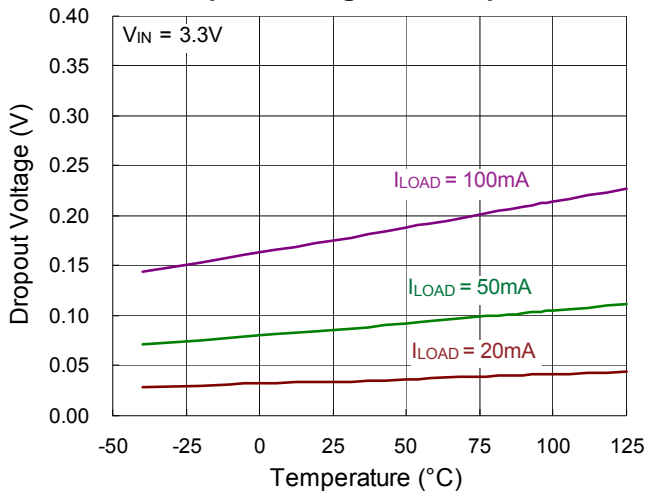

Dropout Voltage vs. Output Current

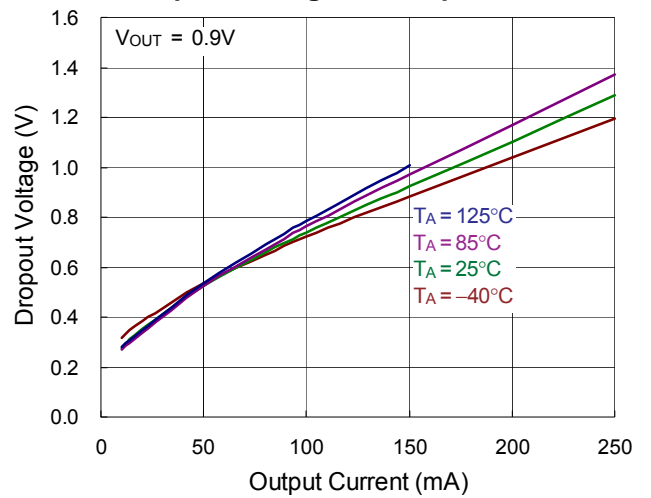



**Dropout Voltage vs. Output Current**

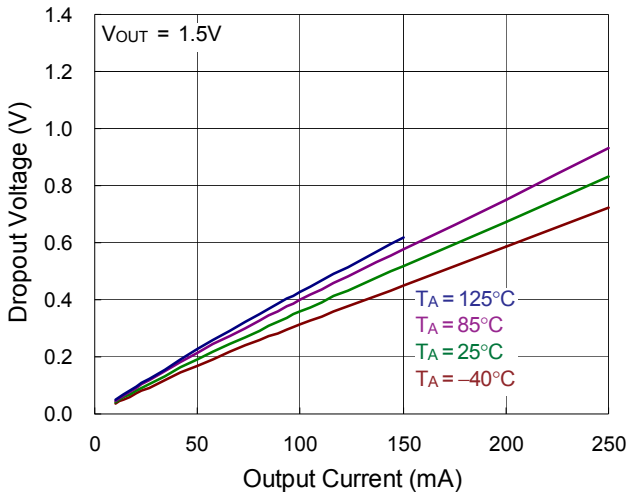

**Dropout Voltage vs. Output Current**

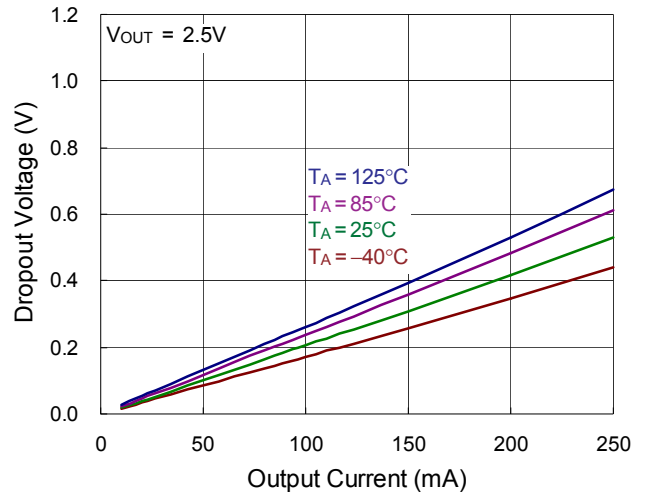

**Current Limit vs. Temperature**

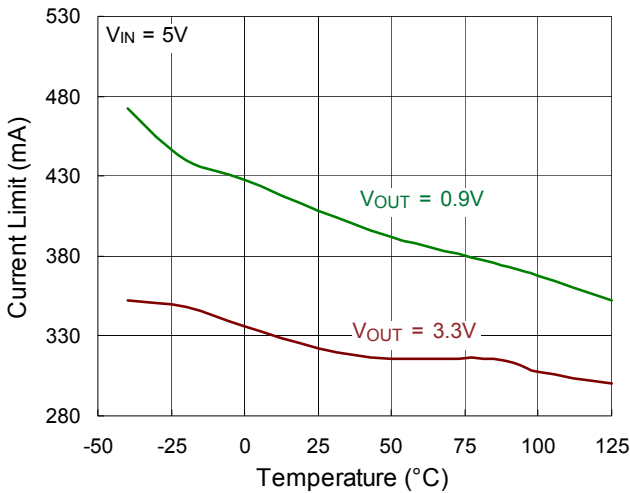

**Fold-Back Current Limit vs. Temperature**

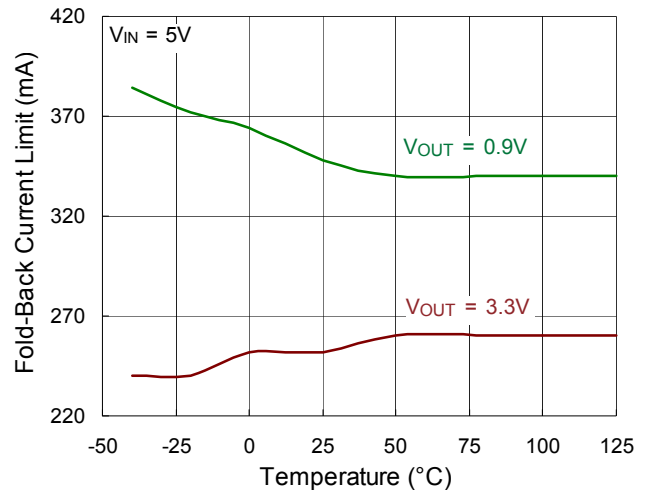

**Ground Current vs. Load Current**

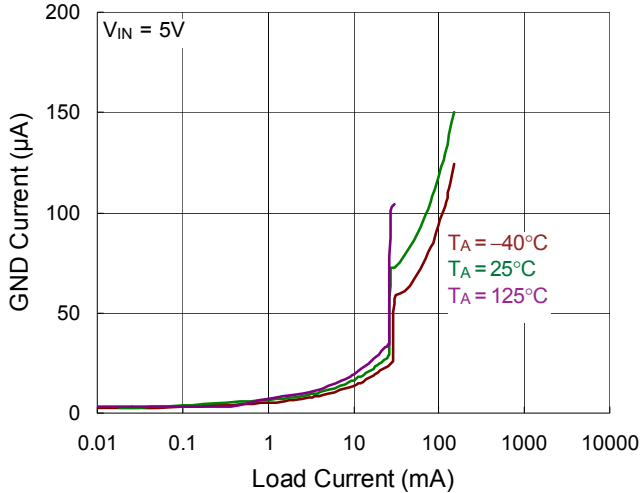

**Power On from EN**

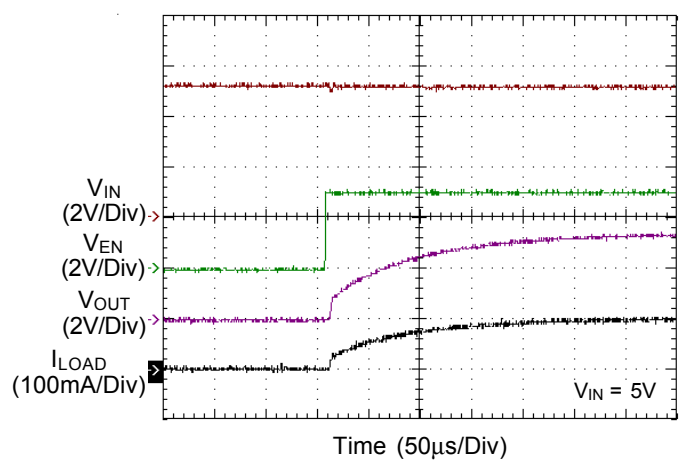

Power Off from EN

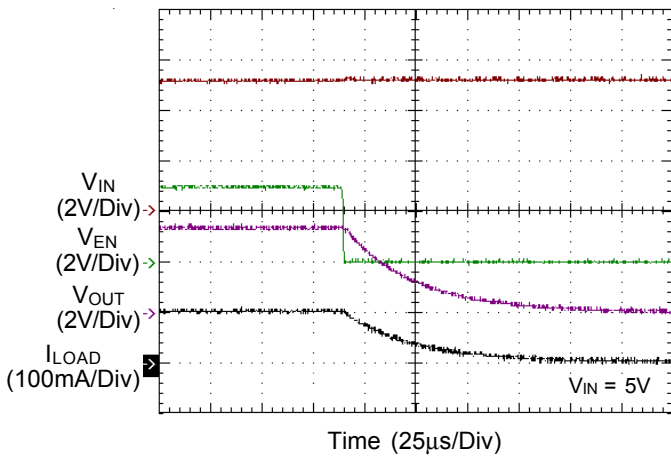

Line Transient

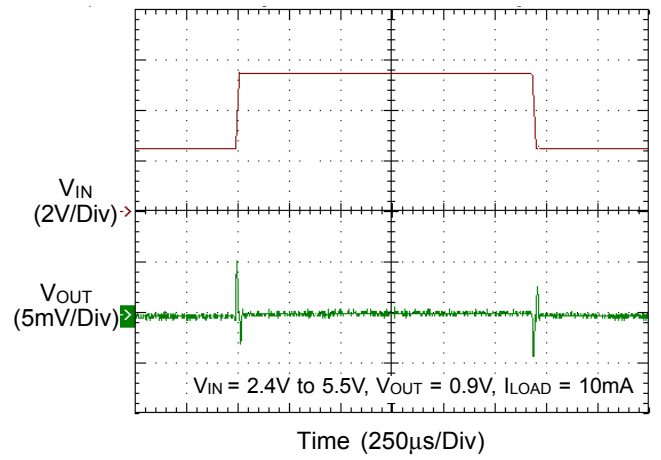

Load Transient

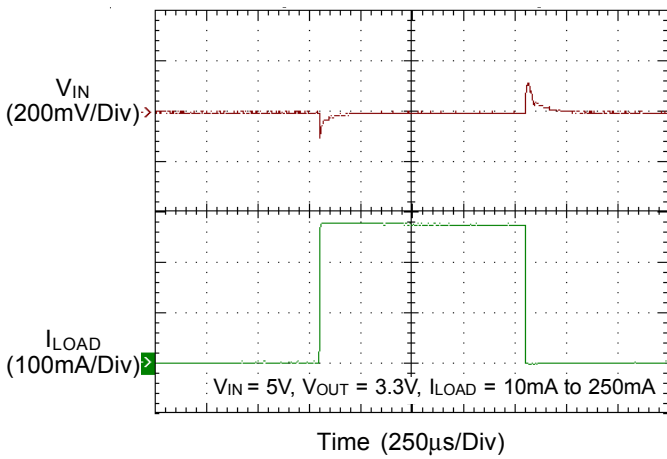

PSRR vs. Frequency

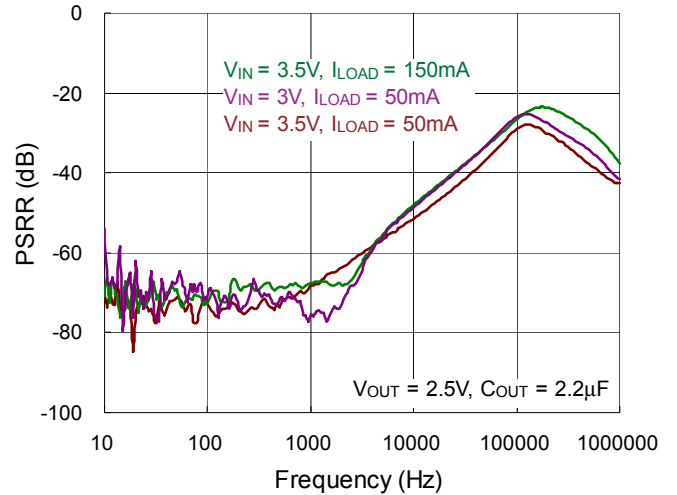

Output Noise

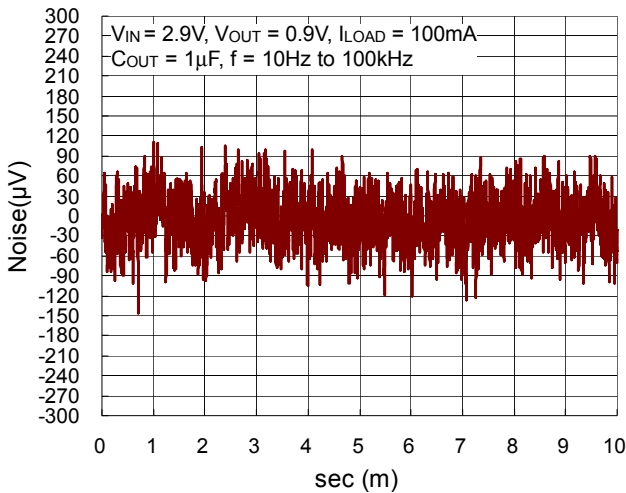

Output Noise

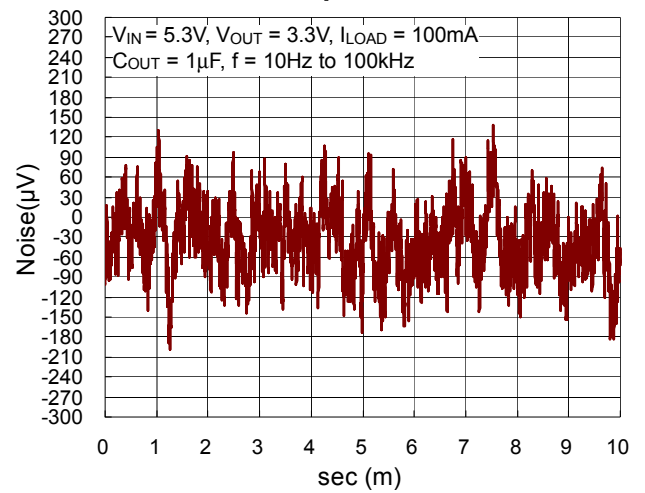

## Application Information

Like any low dropout linear regulator, the RT9073A's external input and output capacitors must be properly selected for stability and performance. Use a 1μF or larger input capacitor and place it close to the IC's VIN and GND pins. Any output capacitor meeting the minimum 1mΩ ESR (Equivalent Series Resistance) and effective capacitance larger than 1μF requirement may be used. Place the output capacitor close to the IC's VOUT and GND pins. Increasing capacitance and decreasing ESR can improve the circuit's PSRR and line transient response.

### Enable

The RT9073A has an EN pin to turn on or turn off the regulator, When the EN pin is in logic high, the regulator will be turned on. The shutdown current is almost 0μA typical. The EN pin may be directly tied to VIN to keep the part on. The Enable input is CMOS logic and cannot be left floating.

### Current Limit

The RT9073A contains an independent current limiter, which monitors and controls the pass transistor's gate voltage, limiting the output current to 0.35A (typ.). The current limiting level is reduced to around 250mA named fold-back current limit when the output voltage is further decreased. The output can be shorted to ground indefinitely without damaging the part.

### Thermal Considerations

For continuous operation, do not exceed absolute maximum junction temperature. The maximum power dissipation depends on the thermal resistance of the IC package, PCB layout, rate of surrounding airflow, and difference between junction and ambient temperature. The maximum power dissipation can be calculated by the following formula :

$$P_{D(MAX)} = (T_{J(MAX)} - T_A) / \theta_{JA}$$

where  $T_{J(MAX)}$  is the maximum junction temperature,  $T_A$  is the ambient temperature, and  $\theta_{JA}$  is the junction to ambient thermal resistance.

For recommended operating condition specifications the maximum junction temperature is 125°C and  $T_A$  is the

ambient temperature. The junction to ambient thermal resistance,  $\theta_{JA}$ , is layout dependent. For ZQFN-4L 1x1 (ZDFN-4L 1x1) package, the thermal resistance,  $\theta_{JA}$ , is 226°C/W on a two-layer Richtek evaluation board. For SC-82 (SSOT-24) package, the thermal resistance,  $\theta_{JA}$ , is 345.6°C/W on a standard JEDEC 51-7 four-layer thermal test board. The maximum power dissipation at  $T_A = 25^\circ\text{C}$  can be calculated by the following formula :

$$P_{D(MAX)} = (125^\circ\text{C} - 25^\circ\text{C}) / (226^\circ\text{C/W}) = 0.44\text{W for ZQFN-4L 1x1 (ZDFN-4L 1x1) package}$$

$$P_{D(MAX)} = (125^\circ\text{C} - 25^\circ\text{C}) / (345.6^\circ\text{C/W}) = 0.28\text{W for SC-82 (SSOT-24) package}$$

The maximum power dissipation depends on the operating ambient temperature for fixed  $T_{J(MAX)}$  and thermal resistance,  $\theta_{JA}$ . The derating curve in Figure 1 allows the designer to see the effect of rising ambient temperature on the maximum power dissipation.

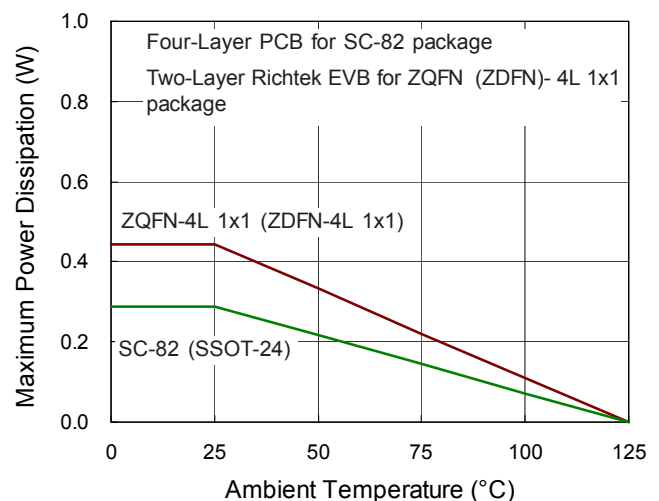
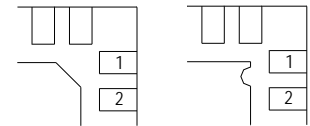
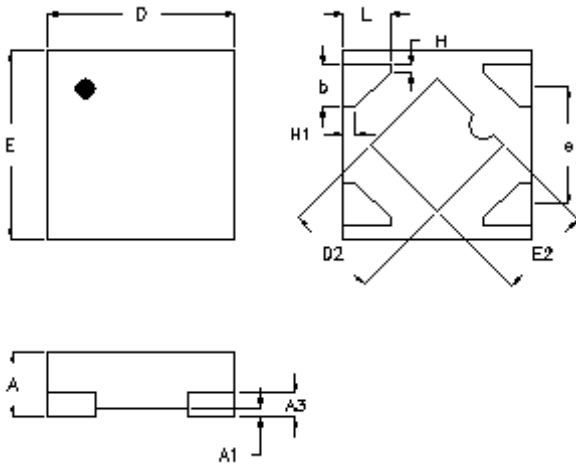

Figure 1. Derating Curve of Maximum Power Dissipation

Outline Dimension



**DETAIL A**

Pin #1 ID and Tie Bar Mark Options

Note : The configuration of the Pin #1 identifier is optional, but must be located within the zone indicated.

Symbol	Dimensions In Millimeters		Dimensions In Inches	
	Min.	Max.	Min.	Max.
A	0.300	0.400	0.012	0.016
A1	0.000	0.050	0.000	0.002
A3	0.117	0.162	0.005	0.006
b	0.175	0.275	0.007	0.011
D	0.900	1.100	0.035	0.043
D2	0.450	0.550	0.018	0.022
E	0.900	1.100	0.035	0.043
E2	0.450	0.550	0.018	0.022
e	0.625		0.025	
L	0.200	0.300	0.008	0.012
H	0.039		0.002	
H1	0.064		0.003	

Z-Type 4L QFN 1x1 Package

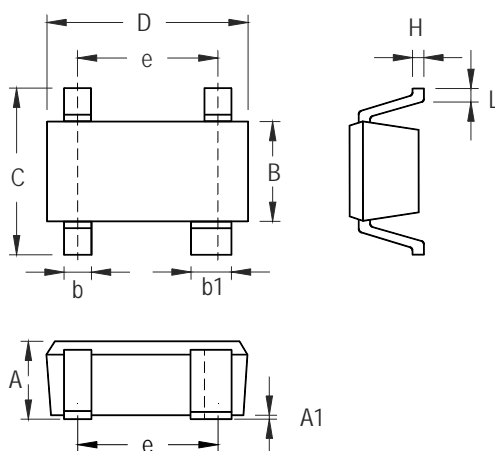

Symbol	Dimensions In Millimeters		Dimensions In Inches	
	Min	Max	Min	Max
A	0.800	1.100	0.031	0.043
A1	0.000	0.100	0.000	0.004
B	1.150	1.350	0.045	0.053
b	0.150	0.400	0.006	0.016
b1	0.350	0.500	0.014	0.020
C	1.800	2.450	0.071	0.096
D	1.800	2.200	0.071	0.087
e	1.300		0.051	
H	0.080	0.260	0.003	0.010
L	0.200	0.460	0.008	0.018

**SC-82 Surface Mount Package**

**Richtek Technology Corporation**

14F, No. 8, Tai Yuen 1<sup>st</sup> Street, Chupei City

Hsinchu, Taiwan, R.O.C.

Tel: (8863)5526789

Richtek products are sold by description only. Richtek reserves the right to change the circuitry and/or specifications without notice at any time. Customers should obtain the latest relevant information and data sheets before placing orders and should verify that such information is current and complete. Richtek cannot assume responsibility for use of any circuitry other than circuitry entirely embodied in a Richtek product. Information furnished by Richtek is believed to be accurate and reliable. However, no responsibility is assumed by Richtek or its subsidiaries for its use; nor for any infringements of patents or other rights of third parties which may result from its use. No license is granted by implication or otherwise under any patent or patent rights of Richtek or its subsidiaries.