

OD4020 Series

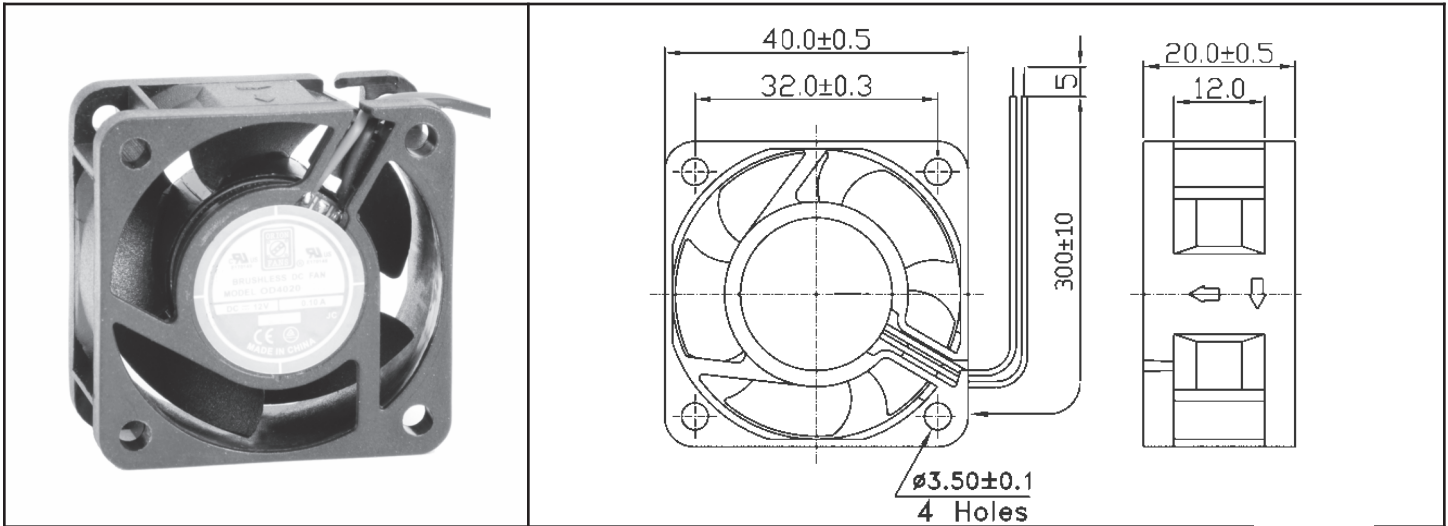

DC Fan - 5, 12, 24V
40x20mm (1.58"x 0.79")



Frame & Impeller	PBT, UL94V-0 plastic	Available Options: Sleeve Bearing Sealed Sleeve Bearing Tachometer Alarm Life Expectancy (L10) Ball - 60,000 hrs (45C) Sleeve - 30,000 hrs (45C) Operating Temperature Ball: -20C ~ 75C Weight: ~0.06 lbs. m1	
Connection	2x Lead wires 26AWG		
Motor	Brushless DC, auto restart, impedance and polarity protected		
Bearing System	Ball bearing		
Insulation Resistance	10M ohm between leadwire and frame (500VDC)		
Dielectric Strength	1 minute at 500 VAC, max leakage < 500 MicroAmp		
Storage Temperature	-40C ~ +80C		

Model Number	Speed (RPM)	Airflow (CFM)	Noise (dB)	Volts DC	Voltage Range (VDC)	Amps	Max. Static Pressure ("H ₂ O)
OD4020-05HB	7800	9	36	5	4 ~ 7	0.29	0.30
OD4020-05MB	6900	8	33	5	4 ~ 7	0.16	0.24
OD4020-05LB	6200	7	30	5	4 ~ 7	0.14	0.19
OD4020-12HB	7800	9	36	12	7 ~ 14	0.10	0.30
OD4020-12MB	6900	8	33	12	7 ~ 14	0.08	0.24
OD4020-12LB	6200	7	30	12	7 ~ 14	0.07	0.19
OD4020-24HB	7800	9	36	24	10 ~ 27	0.09	0.30
OD4020-24MB	6900	8	33	24	10 ~ 27	0.07	0.24
OD4020-24LB	6200	7	30	24	10 ~ 27	0.06	0.19

To indicate sleeve bearing replace "B" suffix with "S" in part number (30,000 hrs life expectancy)
 To indicate sealed sleeve bearing replace "B" with "SS" in part number (50,000 hrs life expectancy)