

## DETAILS

<b>Product Number</b>	FC13976_ANGELINA-RZ-W
<b>Family</b>	ANGELINA
<b>Type</b>	RefPack
<b>Color</b>	metal
<b>Diameter</b>	82 mm
<b>Height</b>	31 mm
<b>Style</b>	round
<b>Optic Material</b>	PC
<b>Holder Material</b>	
<b>Fastening</b>	screw, socket
<b>Status</b>	production ready
<b>ROHS Compliant</b>	Yes
<b>Date Updated</b>	13/03/2015



## OPTICAL PROPERTIES

LED	Viewing Angle	Light Beam	Efficiency	cd/lm	Connector
LUXEON K12	54 deg	Wide	89 %	1.000	TE: 2213134-2 + OPTIC CLIP Z50 TYPE1 2213194-1
LUXEON K16	54 deg	Wide	89 %	0.900	TE: 2213134-2 + OPTIC CLIP Z50 TYPE1 2213194-1
COB J-Type	48 deg	Wide	87 %	0.930	IDEAL: 50-2103NC + 50-2100AN
PrevaLED Core Z4 LES19	55 deg	Wide	88 %	0.870	TE: OPTIC CLIP Z50 TYPE1 2213194-1
Fortimo SLM G5 LES 15 Standard	57 deg	Wide	87 %	0.840	TE: OPTIC CLIP Z50 TYPE1 2213194-1
AC Zhaga COB	64 deg	Wide	89 %	0.780	Optosource: SEHSMJD-A
Mega Zenigata (GW6DME)	55 deg	Wide	89 %	0.890	TE: 2213130-2 + OPTIC CLIP Z50 TYPE1 2213194-1

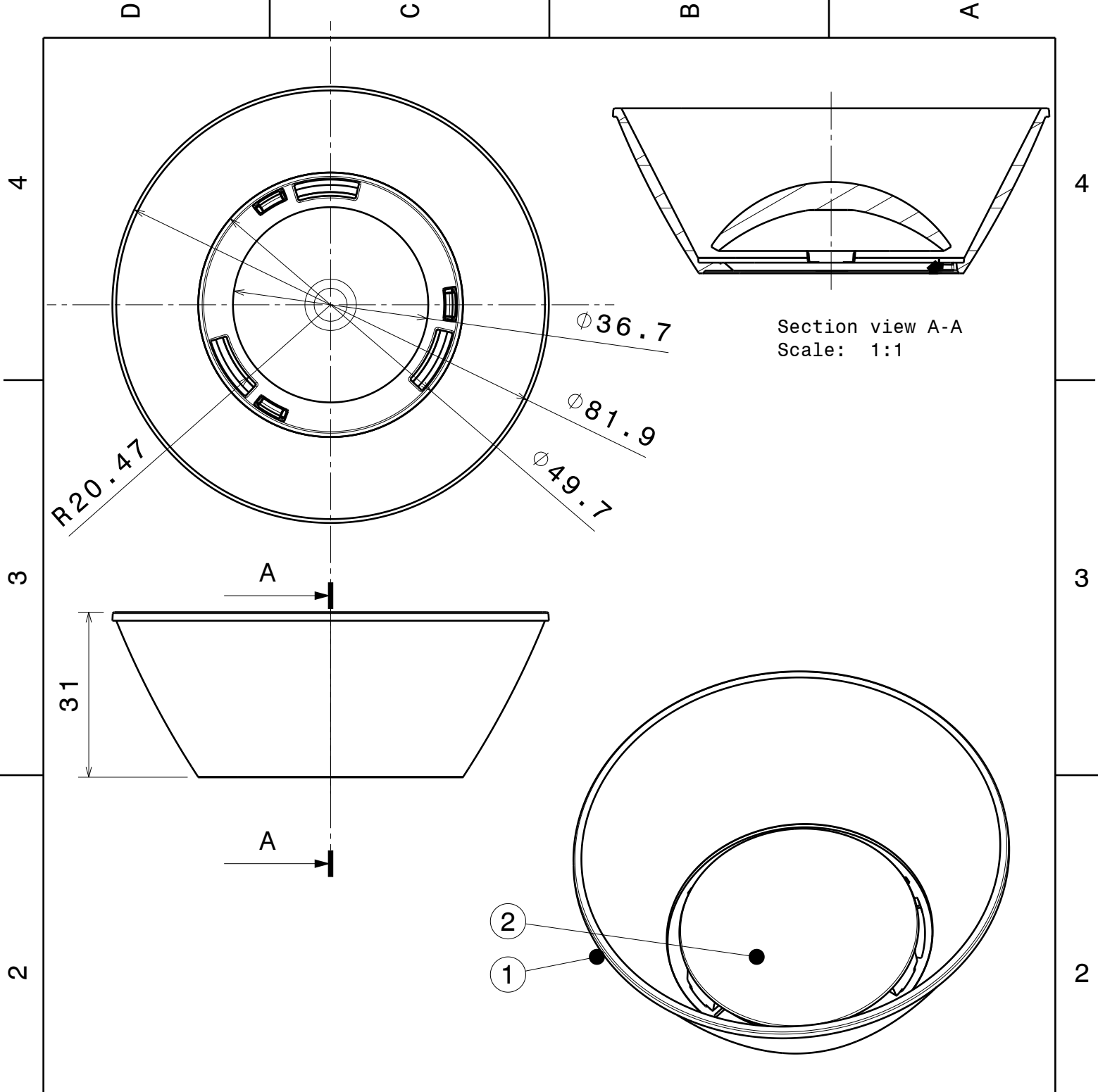

INDEX	PART NO	DESCRIPTION	MATERIAL	COLOUR
1		ANGELINA reflector	PC	metal
2		ANGE-RZ-lens	PC	

Tolerances if not otherwise shown  
 According to DIN ISO 2768-1  
 Linear measures:  
 Up to 30mm class M, otherwise class C.  
 According to DIN ISO 2768-2  
 Form and position: class L

**LEDiL** Ledil Oy  
 Salorankatu 10  
 FIN 24240 SALO  
 Finland

THIRD ANGLE PROJECTION:

DRAWING TITLE  
**Angelina-RZ Assy**

This drawing is the property of LEDiL Oy. It may not be reproduced, copied or communicated without a written agreement with LEDiL Oy."

SIZE PART NUMBER  
**A4**

SCALE 1:1 WEIGHT 16,4 g SHEET 1/1

Luminaire: LEDil Oy FC13976\_ANGELINA-RZ-W\_(Luxeon\_K12) Efficiency=89%  
Lamps: 1 x Luxeon K12 (LXK8-PW40-0012) 930lm @ 250mA CCT=4000K P=8.2W I=250mA

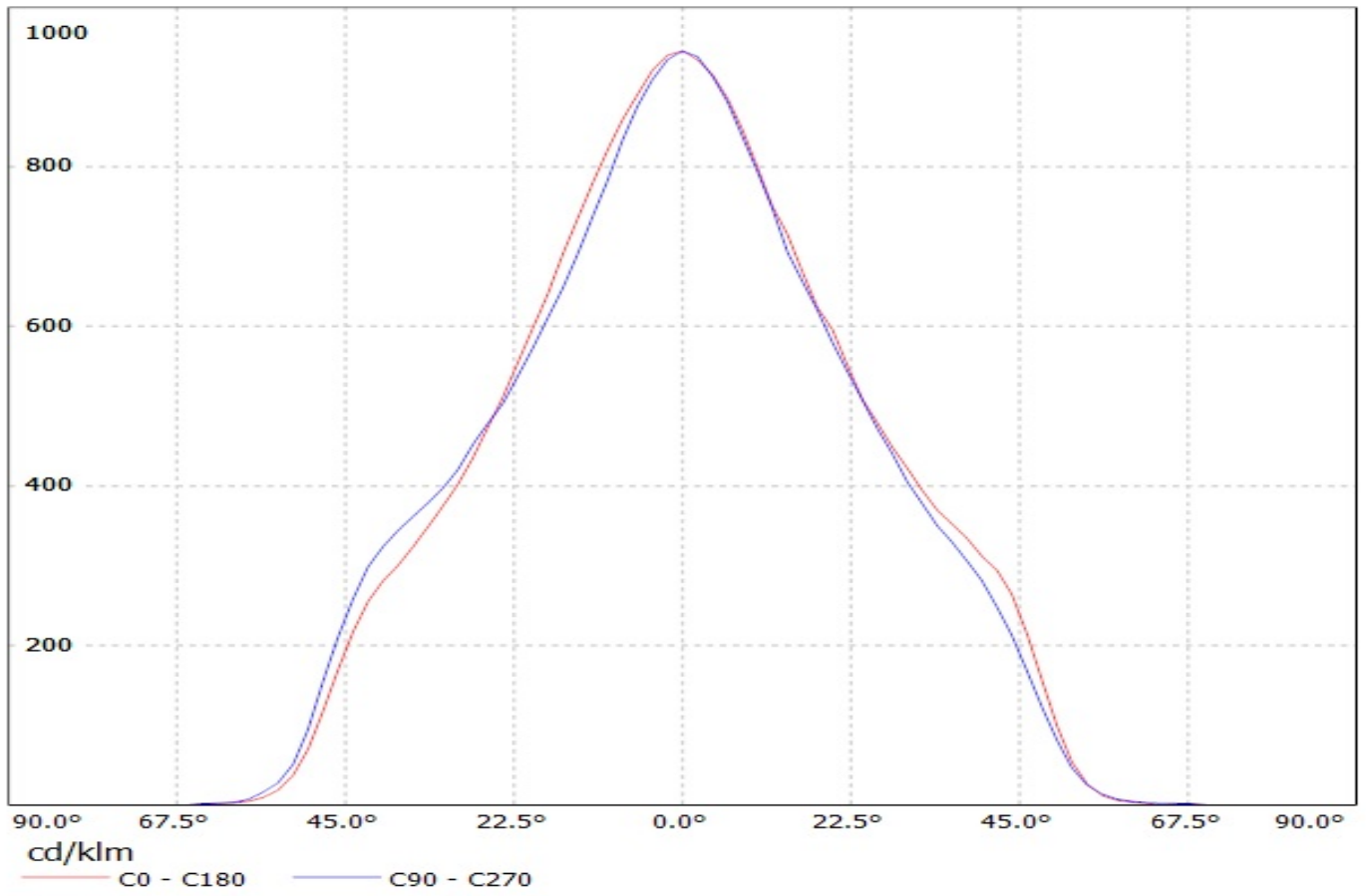

Luminaire: LEDil Oy FC13976\_ANGELINA-RZ-W\_(Luxeon\_K16) Efficiency=89%  
Lamps: 1 x Luxeon K16 (LXK8-PW40-0016) 1200lm @ 250mA CCT=4000K P=10.9W I=250mA

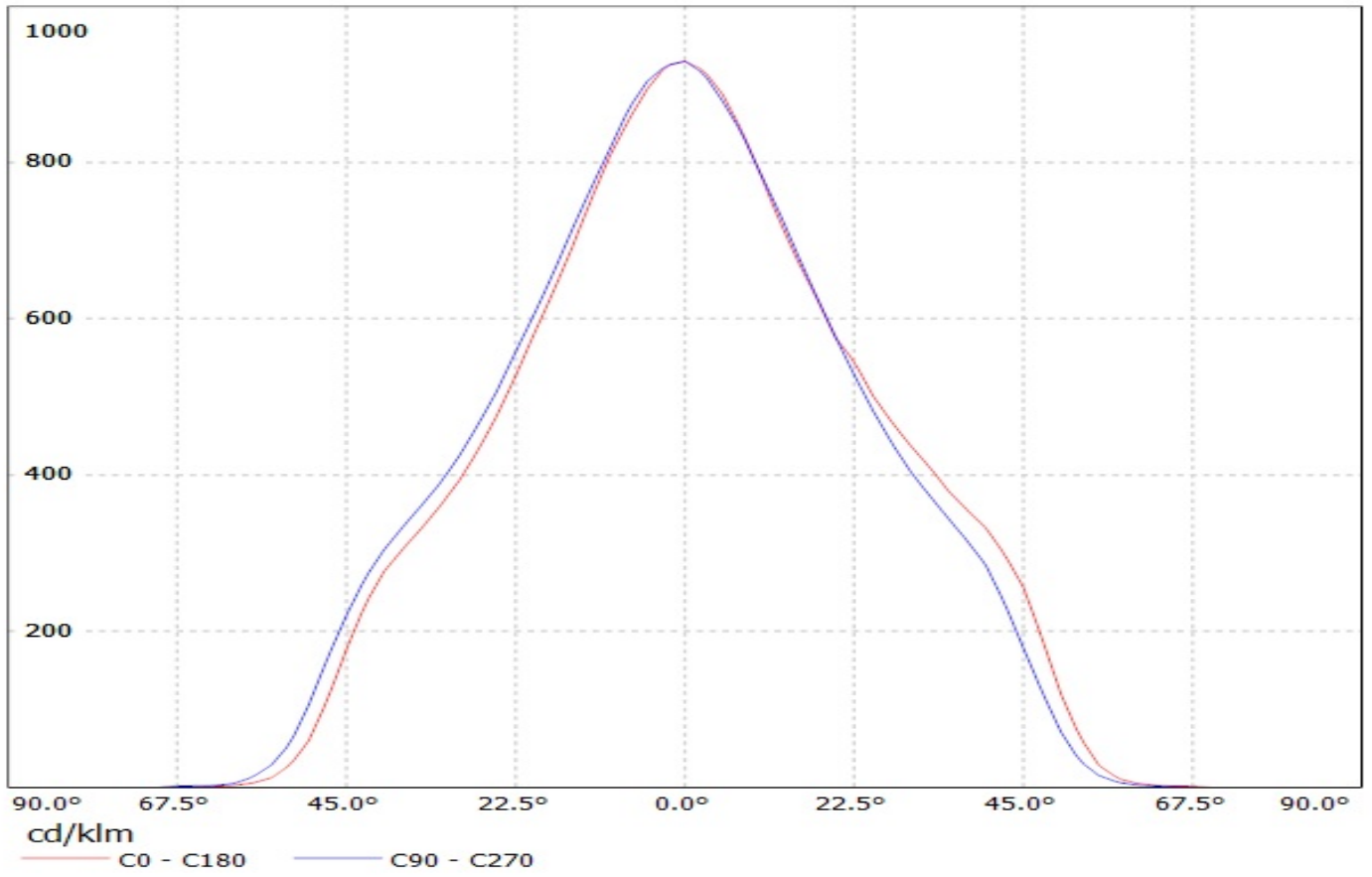

Luminaire: LEDiL Oy FC13976\_ANGELINA-RZ-W\_(NFDLJ130B+IDEAL)

Lamps: 1 x Nichia\_NFDLJ130B\_+50-2103NC\_+50-2100AN\_1422.52lm@250mA\_CCT=4000K\_P=8.91686W\_I=0.25A

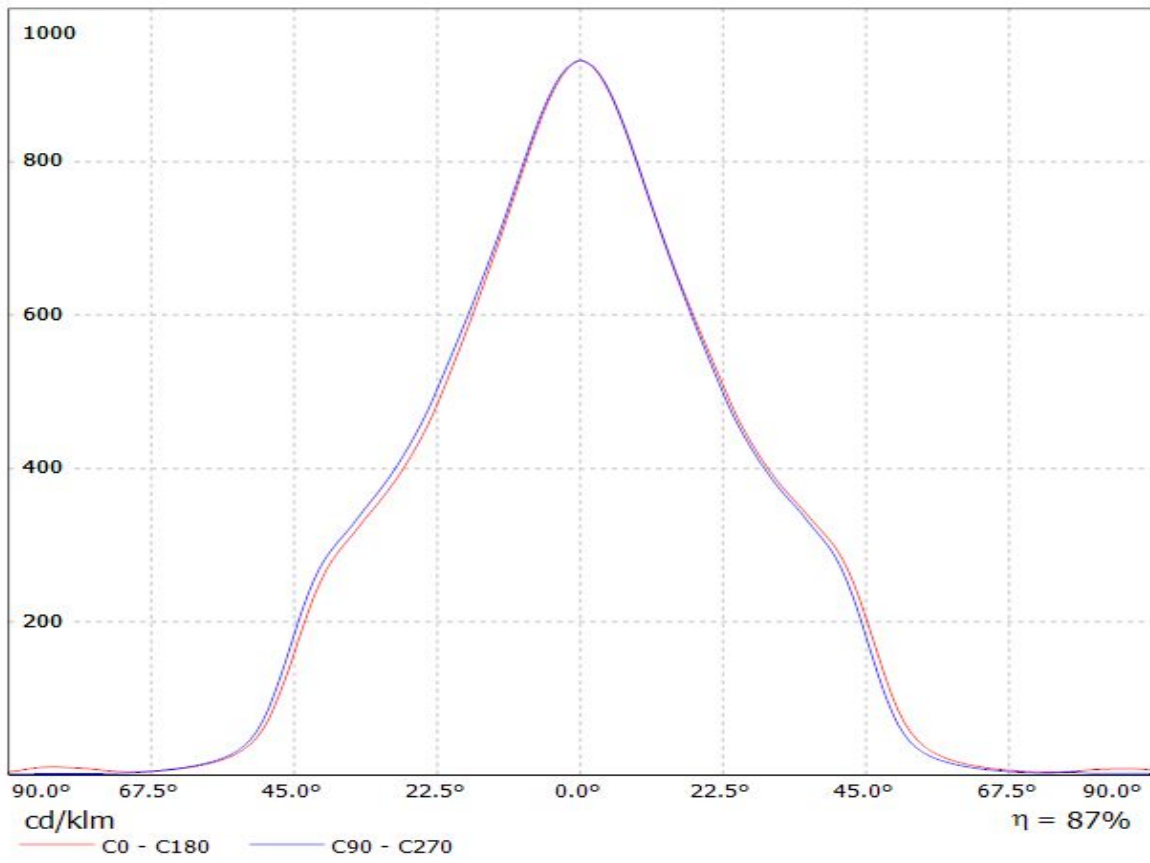

Luminaire: Ledil FC13976\_ANGELINA-RZ-W\_(PREVALED\_Core\_Z4)  
Lamps: 1 x PREVALED\_Core\_Z4\_LES19\_1470.62lm@250mA\_P=10.828W\_I=0.25A

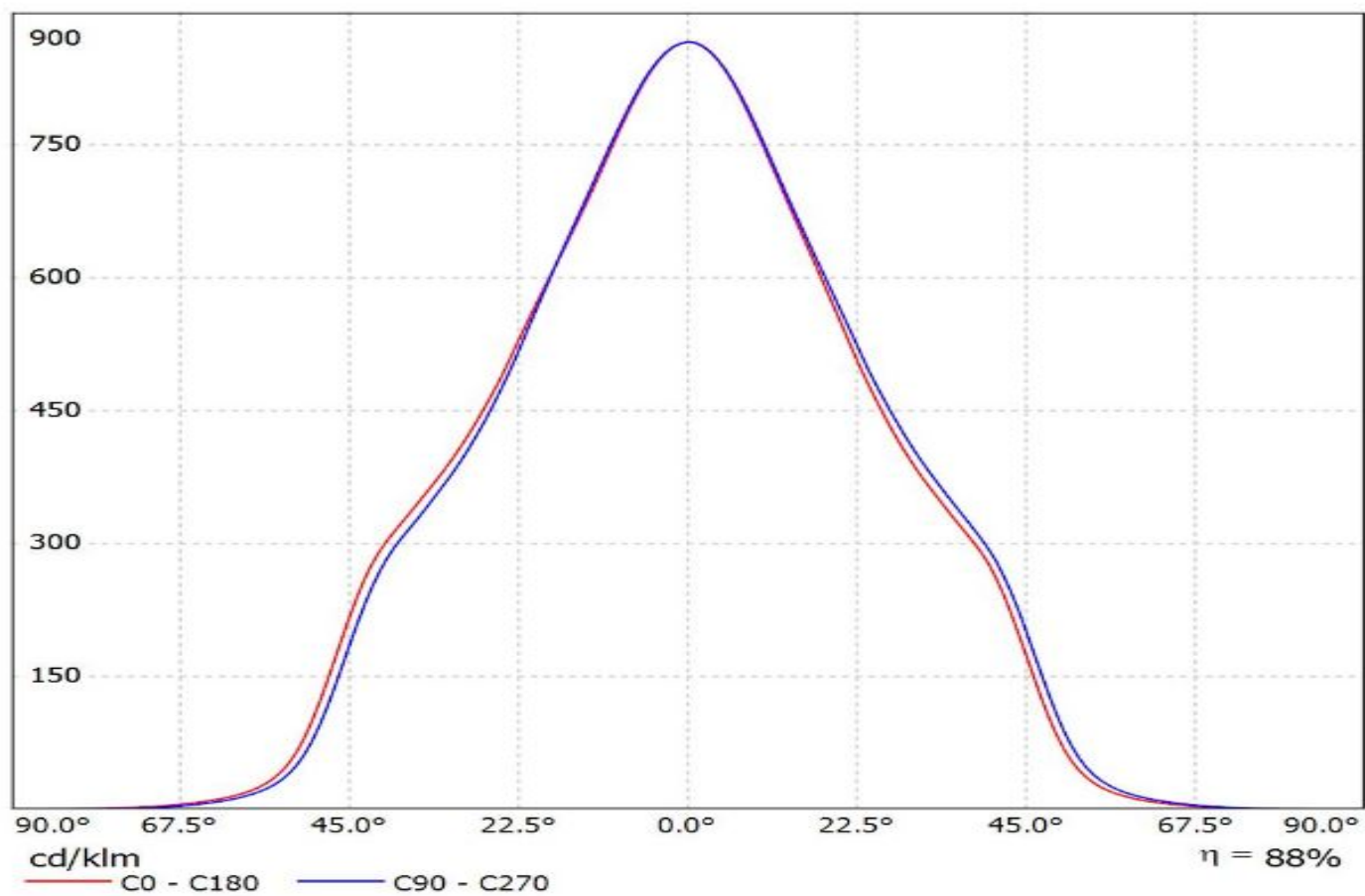

Luminaire: Ledil FC13976\_ANGELINA-RZ-W\_(SLM\_G5\_LES\_15\_+TE)

Lamps: 1 x Philips\_SLM\_G5\_LES\_15\_+TE\_2213194-1\_1277.72lm@250mA\_P=8.208W\_I=0.25A

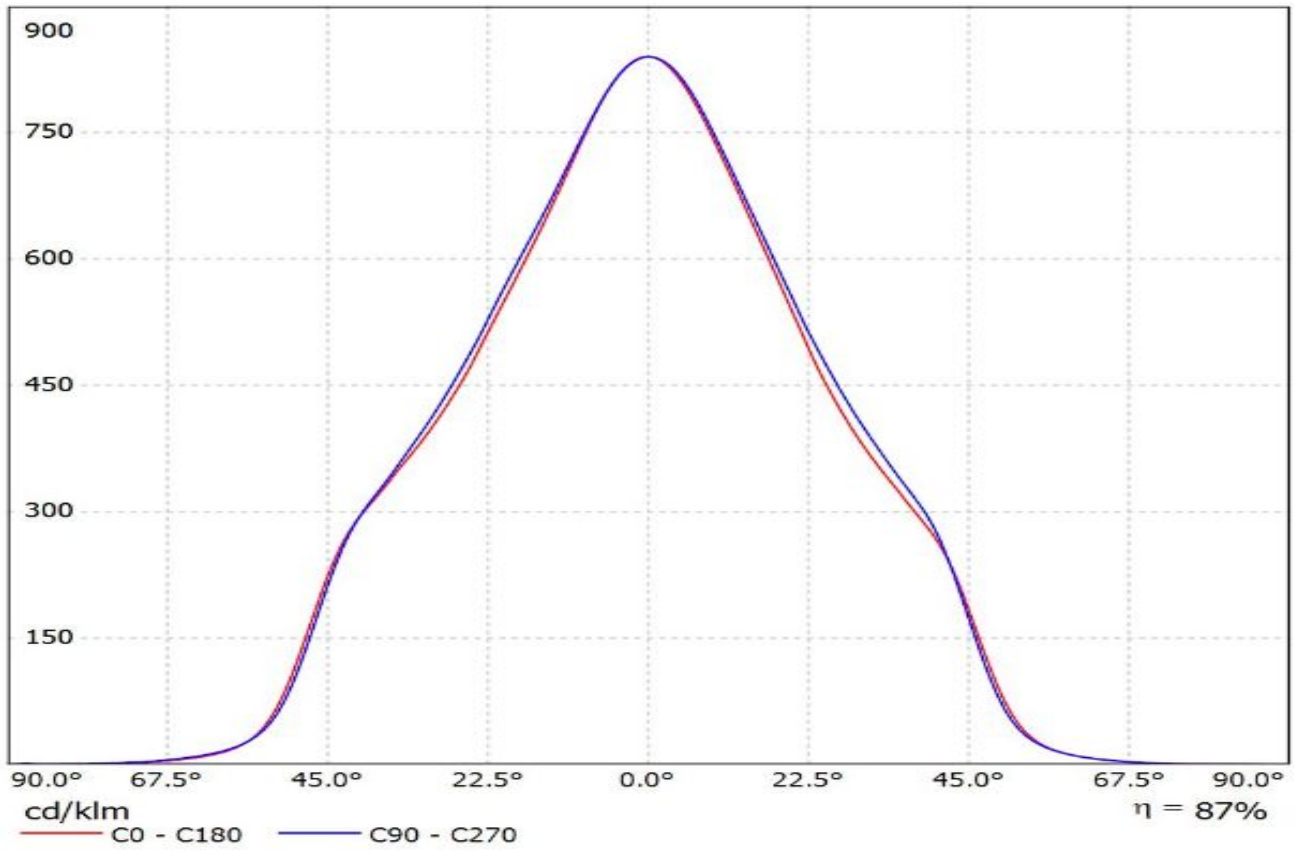

Luminaire: Ledil FC13976\_ANGELINA-RZ-W\_(SEOUL\_AC\_Zhaga\_COB)  
Lamps: 1 x SEOUL\_AC\_Zhaga\_COB

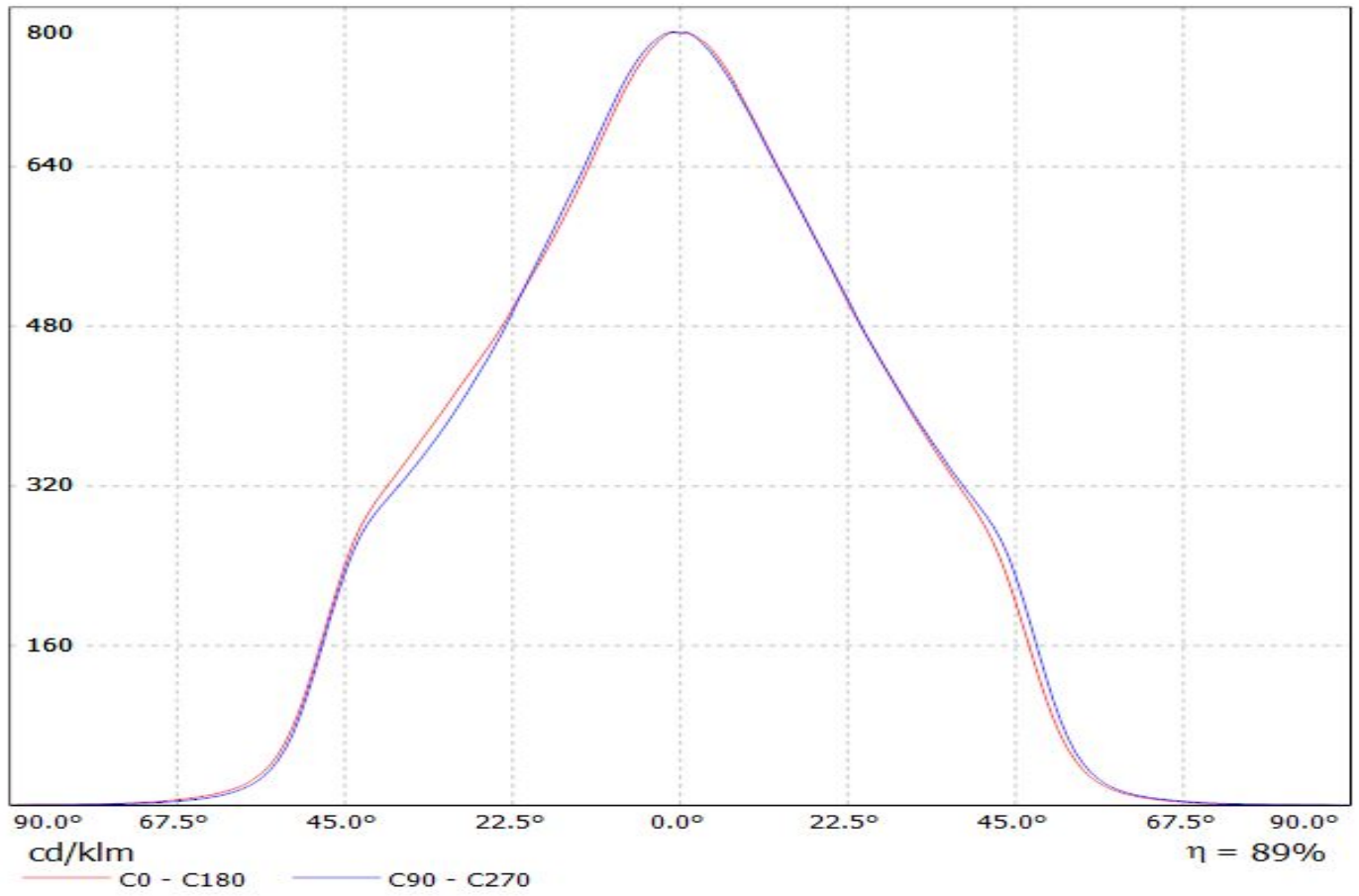



# Ledil FC13976\_ANGELINA-RZ-W\_(MEZ\_GW6) / LDC (Linear)

Luminaire: Ledil FC13976\_ANGELINA-RZ-W\_(MEZ\_GW6)  
Lamps: 1 x SHARP\_Megazenigata\_(GW6DME30NFC)  
\_1261.85lm@250mA\_CCT=3038K\_P=11.172W\_I=0.25A

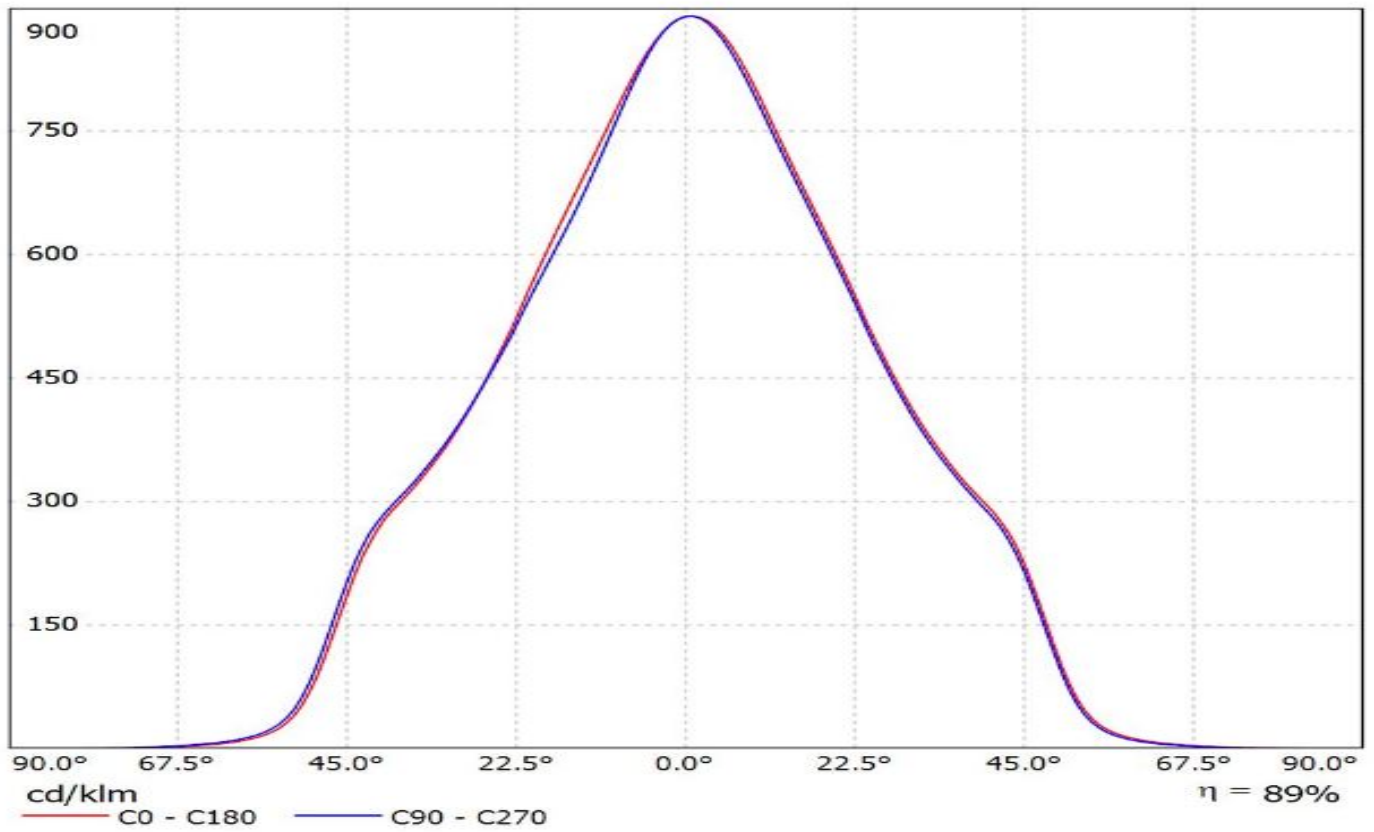

Luminaire: LEDil Oy FC13976\_ANGELINA-RZ-W\_(Luxeon\_K12) Efficiency=89%  
Lamps: 1 x Luxeon K12 (LXK8-PW40-0012) 930lm @ 250mA CCT=4000K P=8.2W I=250mA

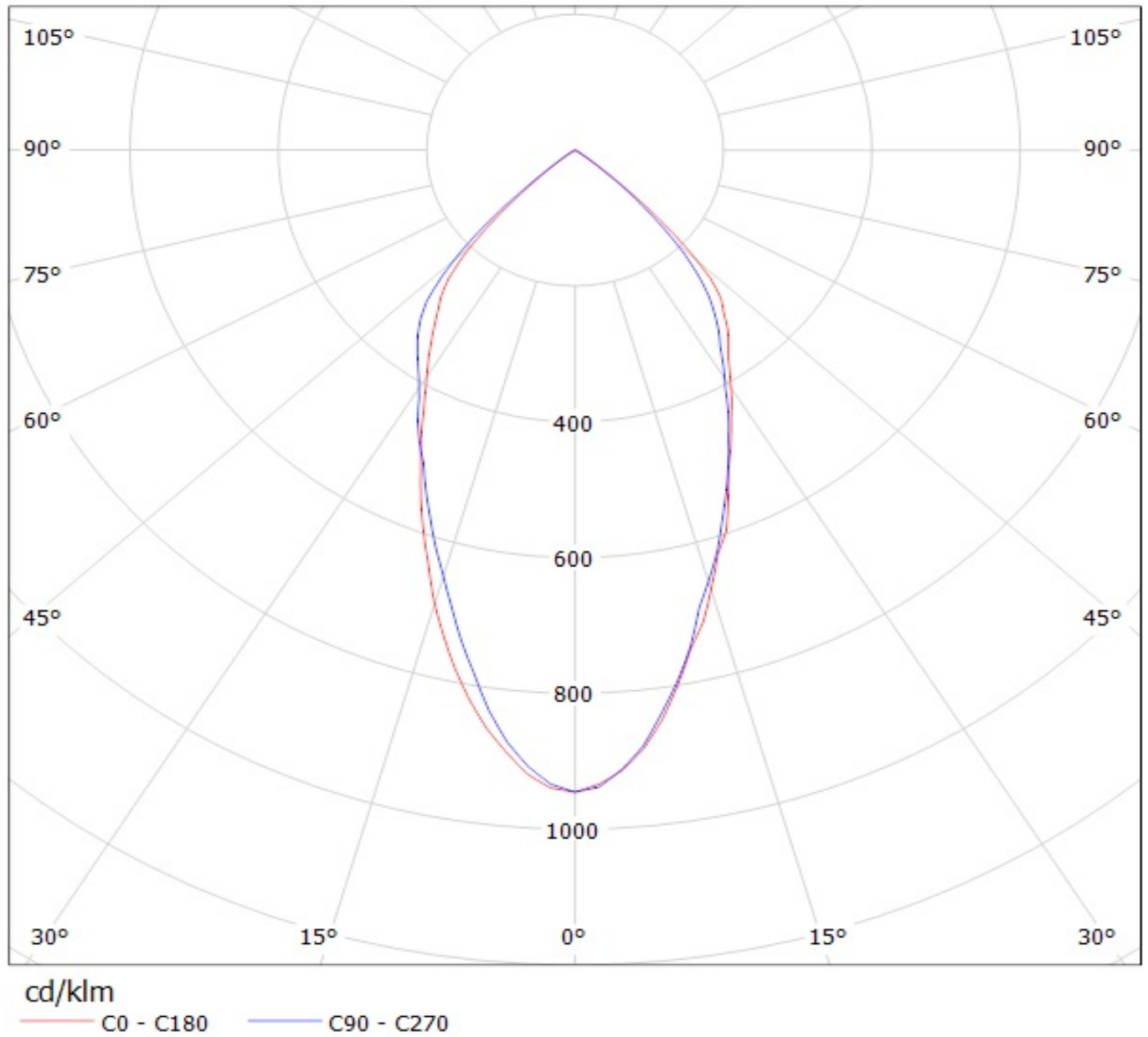

Luminaire: LEDil Oy FC13976\_ANGELINA-RZ-W\_(Luxeon\_K16) Efficiency=89%  
Lamps: 1 x Luxeon K16 (LXK8-PW40-0016) 1200lm @ 250mA CCT=4000K P=10.9W I=250mA

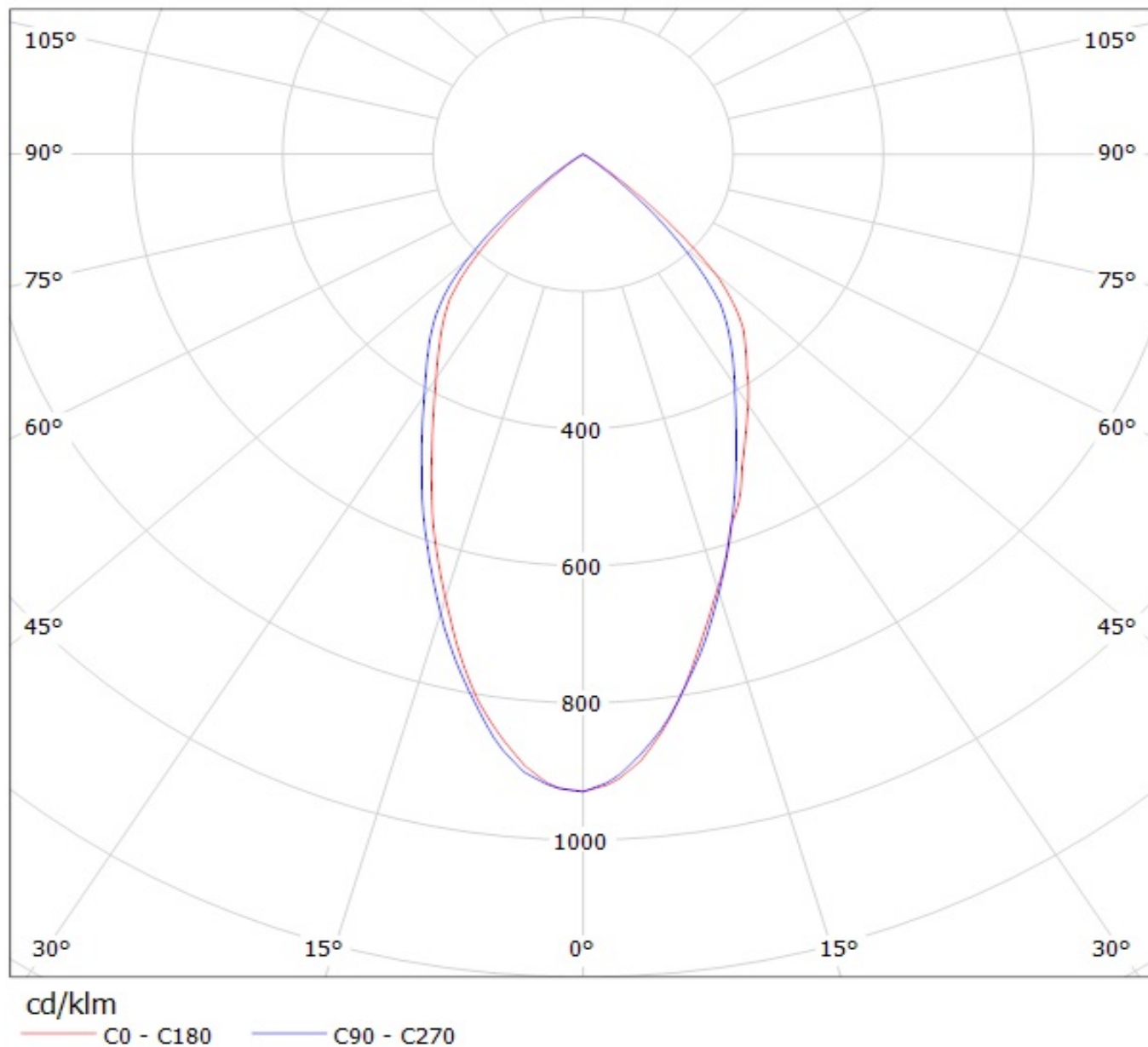

Luminaire: LEDiL Oy FC13976\_ANGELINA-RZ-W\_(NFDLJ130B+IDEAL)

Lamps: 1 x Nichia\_NFDLJ130B\_+50-2103NC\_+50-2100AN\_1422.52lm@250mA\_CCT=4000K\_P=8.91686W\_I=0.25A

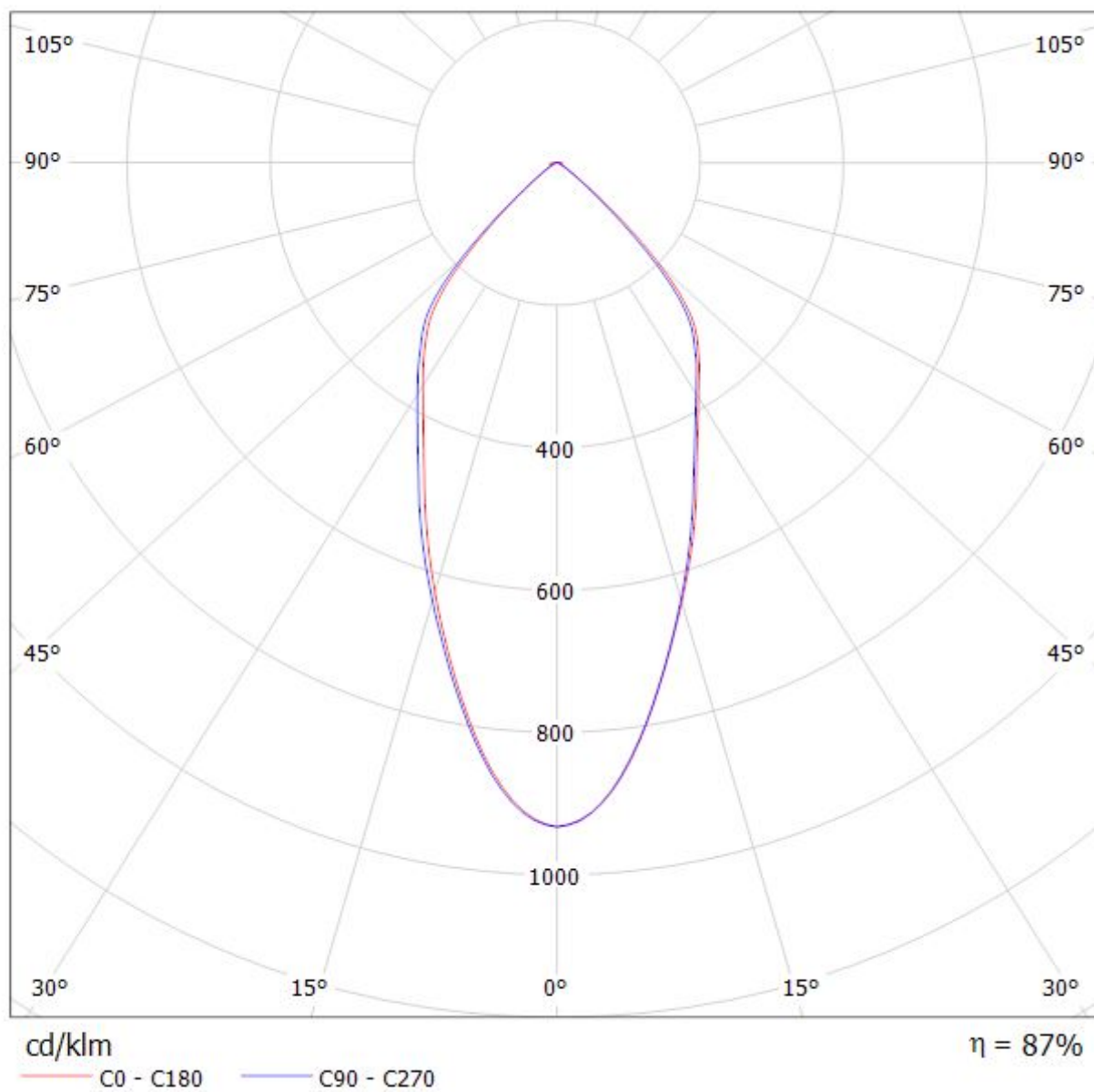

Luminaire: Ledil FC13976\_ANGELINA-RZ-W\_(PREVALED\_Core\_Z4)

Lamps: 1 x PREVALED\_Core\_Z4\_LES19\_1470.62lm@250mA\_P=10.828W\_I=0.25A

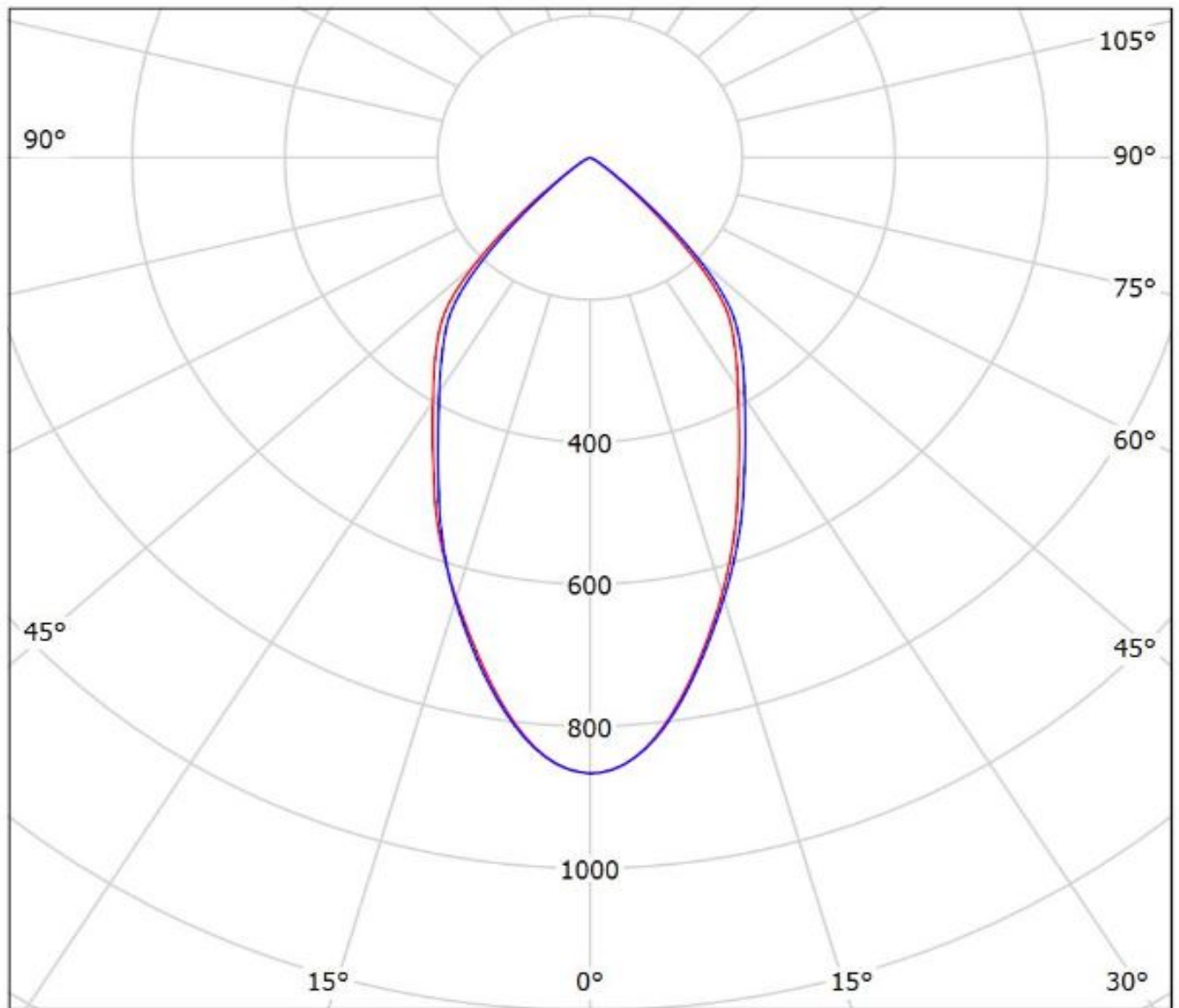

cd/klm

— C0 - C180 — C90 - C270

$\eta = 88\%$

Luminaire: Ledil FC13976\_ANGELINA-RZ-W\_(SLM\_G5\_LES\_15\_+TE)

Lamps: 1 x Philips\_SLM\_G5\_LES\_15\_+TE\_2213194-1\_1277.72lm@250mA\_P=8.208W\_I=0.25A

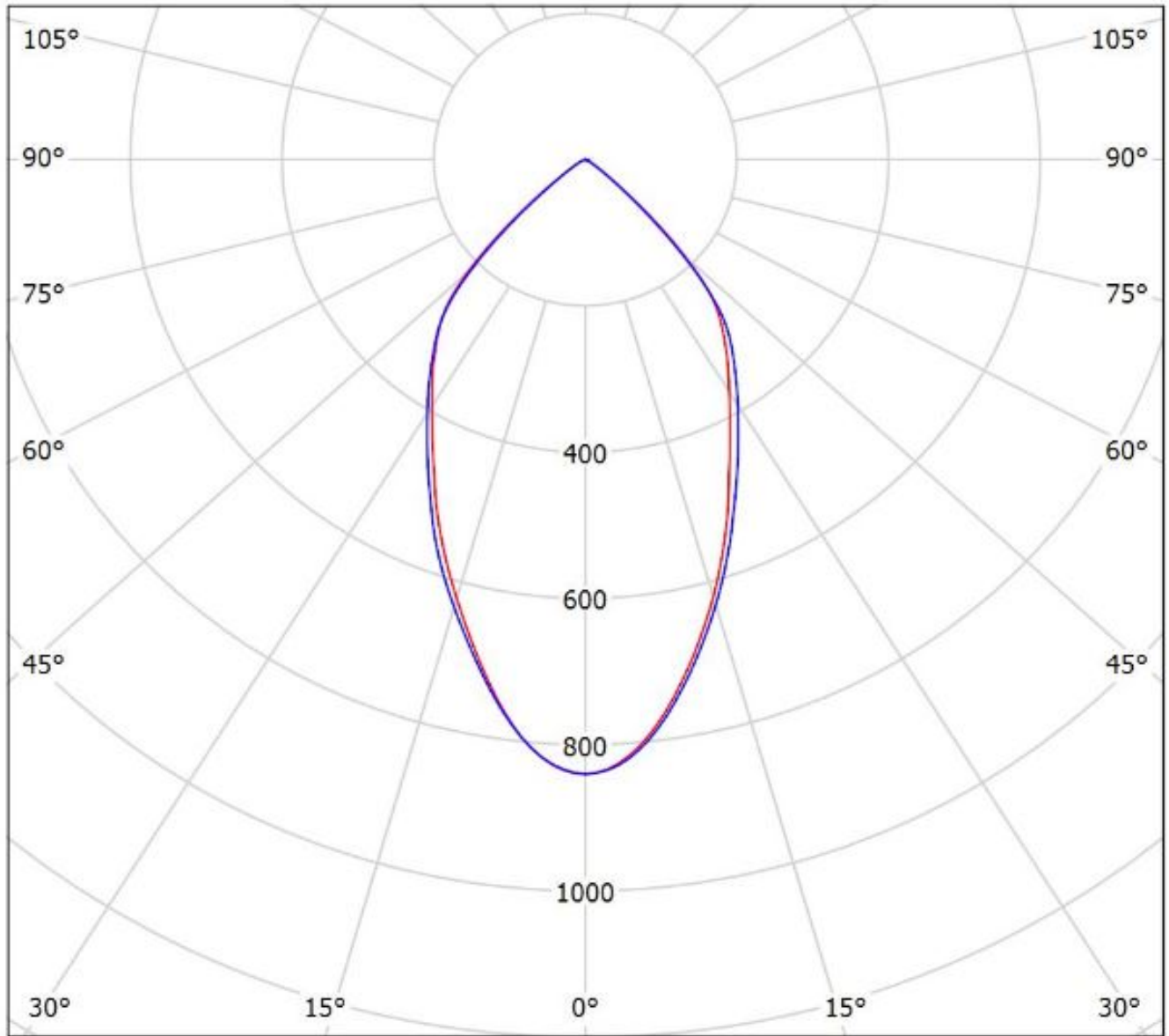

cd/klm

— C0 - C180 — C90 - C270

$\eta = 87\%$

Luminaire: Ledil FC13976\_ANGELINA-RZ-W\_(SEOUL\_AC\_Zhaga\_COB)  
Lamps: 1 x SEOUL\_AC\_Zhaga\_COB

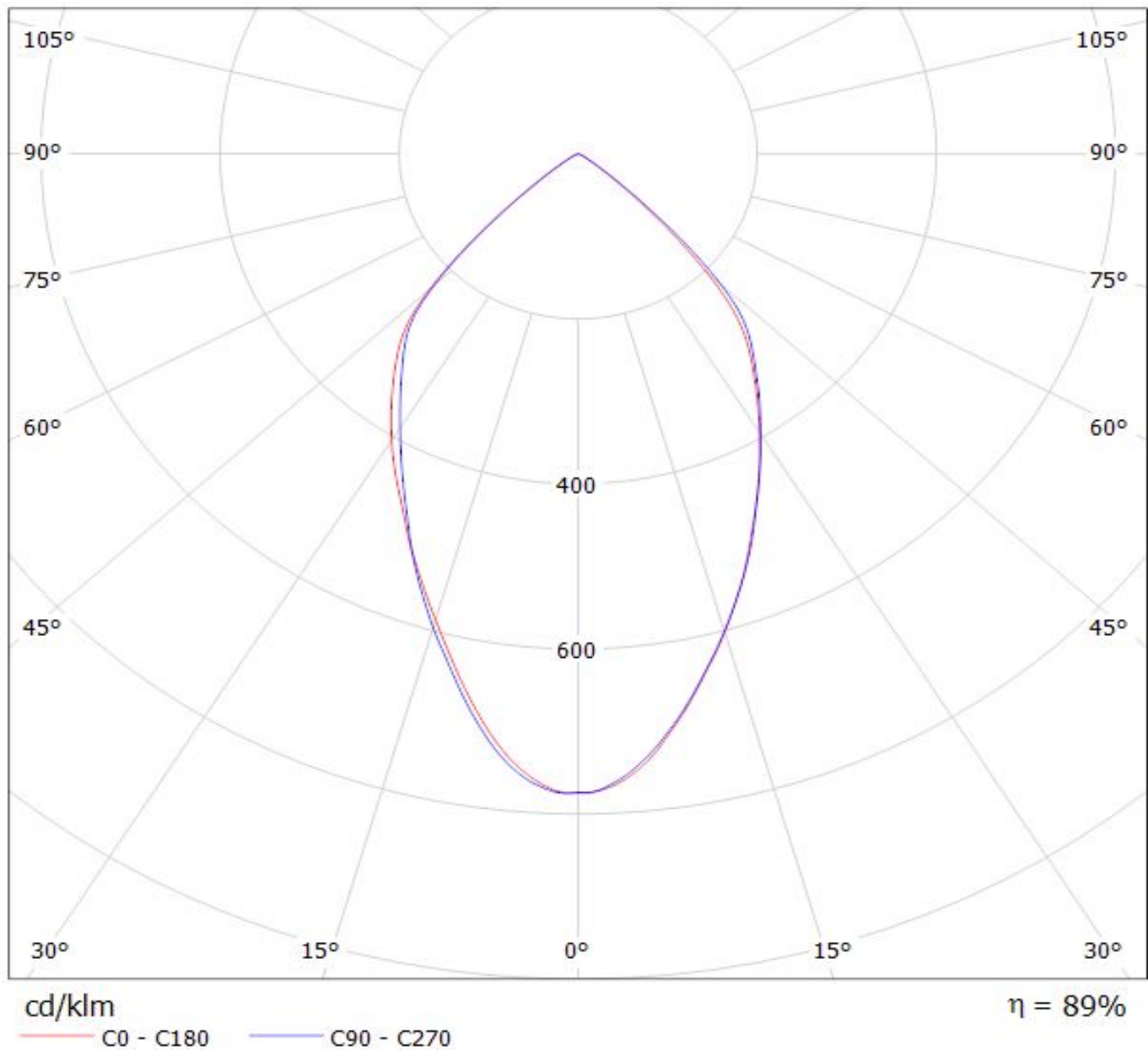

# Ledil FC13976\_ANGELINA-RZ-W\_(MEZ\_GW6) / LDC (Polar)

Luminaire: Ledil FC13976\_ANGELINA-RZ-W\_(MEZ\_GW6)  
Lamps: 1 x SHARP\_Megazenigata\_(GW6DME30NFC)  
\_1261.85lm@250mA\_CCT=3038K\_P=11.172W\_I=0.25A

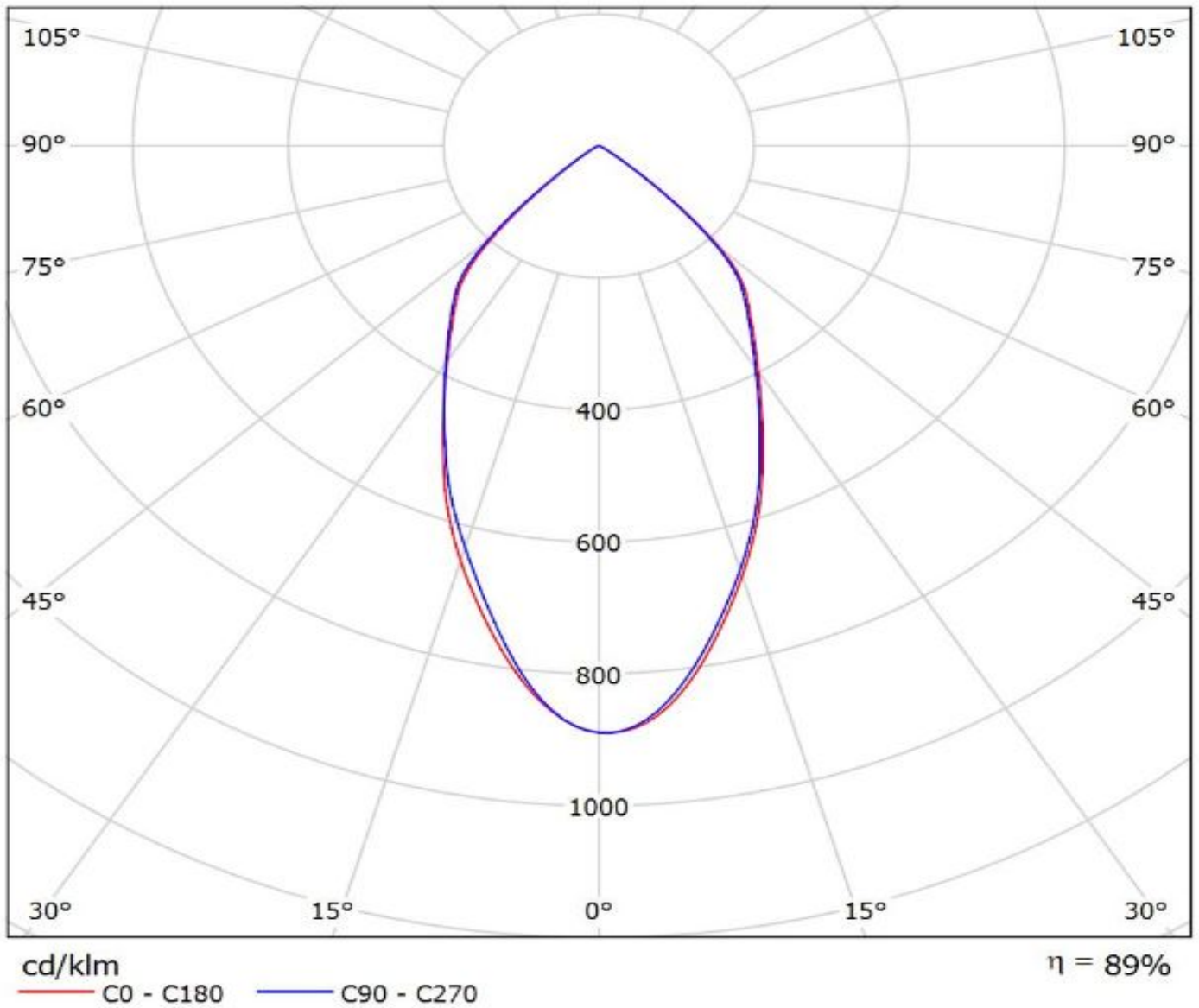



**NOTE: The typical divergence will be changed by different color, chip size and chip position tolerance. The typical total divergence is the full angle measured where the luminous intensity is half of the peak value.**

### **GENERAL INFORMATION**

- Product series especially designed & optimized for series of LEDs.
- Special care taken to make light distribution as uniform as possible.

Note! Due to use of high power COB's with this product, special attention to proper thermal design is highly recommended. LEDiL has no liability for direct, indirect or consecutive damages arising from the LEDiL products being used outside of the recommended temperature range.